

# HAND TOOLS

**KREATOR**

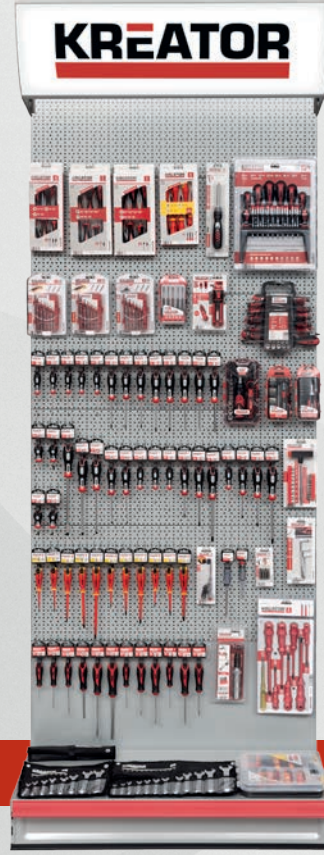

# Index

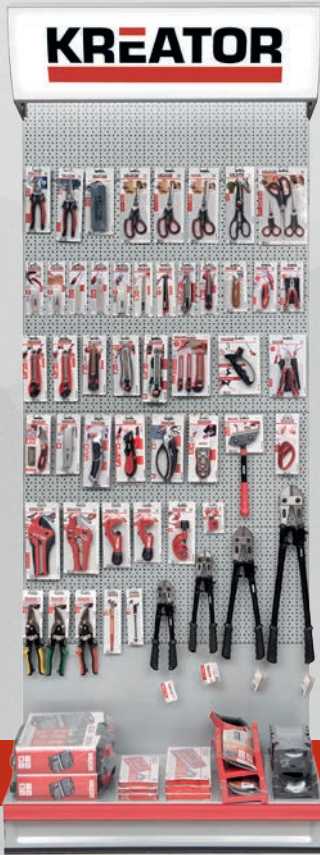

**CUTTING**

- CUTTERS & HEAVY DUTY KNIVES P 5
- SCRAPERS P 6
- SPARE BLADES P 7
- SCISSORS P 7
- HEAVY DUTY SCISSORS P 8
- HOBBY KNIVES P 8
- TUBE CUTTERS P 9
- GLASS CUTTERS P 9
- TILE CUTTERS P 10
- TAP & DIE SETS P 10



**MEASURING**

- FOLDING RULERS P 20
- MEASURING TAPES P 20
- LEVEL RULERS P 21
- TRY-SQUARES P 21
- CALLIPERS P 22
- BRIDGE LEVELS P 23
- SPIRIT LEVELS P 23
- TORPEDO LEVELS P 23
- BEVEL SQUARE P 23
- CHALK LINES P 24
- PLUMB BOB P 24
- PENCILS P 24
- LASERS P 25



**SCREWDRIVERS**

- SCREWDRIVERS P 52
  - SLOTTED
  - PHILLIPS
  - POZI
  - TX
  - STUBBY
  - AWLS
  - MAGNETIC BIT HOLDER
- VOLTAGE TESTERS P 54
- PRECISION SCREWDRIVERS P 55
- SCREWDRIVER SETS P 55
- SPECIAL SCREWDRIVERS P 57
- HEY KEYS P 58



**PLIERS**

- PLIERS P 67
  - LONG NOSE
  - CIRCLIP
  - BENT NOSE
  - COMBINATION
  - DIAGONAL
  - BIG HEAD DIAGONAL
  - VDE
  - MINI
- WIRE STRIP PLIERS P 70
- REVOLVING LEATHER PUNCH PLIERS P 70
- CRIMPING TOOLS P 71
- GROMMET PLIERS P 71
- RIVETING PLIERS P 72
- HOLLOW ANCHOR PLIERS P 73
- WATER PUMP PLIERS P 74
- LOCKING PLIERS P 74
- CARPENTER PINCERS P 75
- TOWER PINCERS P 75
- HEAVY DUTY SCISSORS P 76
- TIN SNIPS P 76
- BOLT CUTTERS P 76



**SAWS**

- HANDSAWS P 11
- CONCRETE SAW P 11
- MITRE SAWS + BOXES P 11
- WALLBOARD SAW P 12
- COMPASS SAW P 12
- FRETSAW P 12
- BOW SAWS P 13
- METAL SAWS P 13
- CROSS SAWS P 14
- MINI SAWS P 14
- SPARE SAW BLADES P 15



**SPANNERS, WRENCHES & SOCKETS**

- SPANNERS P 29
- SPANNER SETS P 31
- TUBULAR WRENCHES P 33
- RATCHET WRENCHES P 33
- SOCKETS P 34
- UNIVERSAL JOINTS & ADAPTORS P 34
- SOCKET SETS P 34
- PIPE AND NUT WRENCHES P 38
- ADJUSTABLE WRENCHES P 39
- OTHER WRENCHES P 39



**HAMMERS**

- MACHINIST HAMMERS P 60
- STONING HAMMERS P 60
- CLAW HAMMERS P 61
- ROOFING HAMMER P 61
- MASON'S HAMMER P 61
- AXE HAMMER P 62
- DEAD BLOW MALLET P 62
- BEECHWOOD MALLET P 62
- RUBBER MALLET P 62



**CHISELS & WRECKING BARS**

- WOOD CHISELS P 77
- COLD CHISELS P 77
- NAIL & CENTER PUNCHES P 78
- NAIL PULLERS P 79
- WRECKING BARS P 79



**FILING, GRATING & CARVING**

- FILES P 16
- WOOD RASPS P 17
- RASPS & BLOCK PLANES P 17
- MODELLING & CARVING P 18
- SCRIBERS P 19
- SHARPENING STONES P 19



**FASTENING & MAINTENANCE**

- CLAMPS & HOLDERS P 40
- RATCHET TIE DOWNS & CARRIER STRAPS P 42
- STRAPS P 44
- BENCH VICES P 44
- GLASS SUCTION CUPS P 45
- CAULKING GUNS P 45
- PADLOCKS P 46
- STAPLERS & TACKER P 47
- STAPLES & NAILS P 48
- MAINTENANCE P 50



**TOOL SETS**

- COMBINATION TOOL SETS P 63



**SAFETY**

- EYE PROTECTION P 80
- HEARING PROTECTION P 81
- KNEE PADS P 81
- DUST MASKS P 82
- HEAD PROTECTION P 83
- GLOVES P 84
  - WORK GLOVES
  - GARDEN GLOVES
  - TECHNICAL GLOVES
  - KIDS GLOVES



**TRANSPORT, TRESTLES, WORKBENCHES, TOOL CABINETS & TARPAULINS**

- TRANSPORT CART P 91
- PLATFORM CARTS P 91
- QUICK FOLDING CARTS P 91
- HAND TRUCKS P 92
- TRESTLES P 93
- WORKBENCHES P 93
- TOOL CABINETS P 94
- TARPAULINS P 95
- PLASTIC COVERS P 95

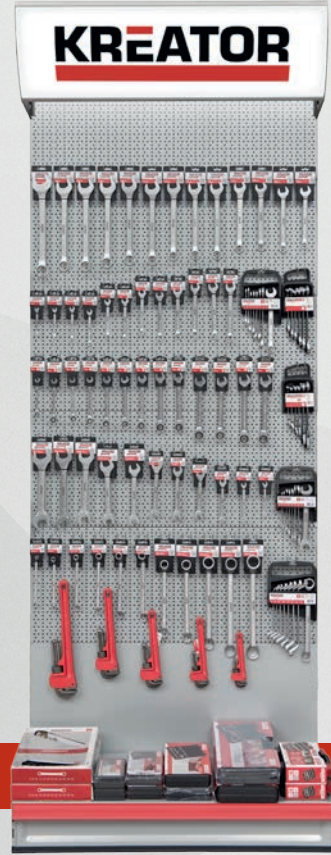

# Cutting

## CUTTERS & HEAVY DUTY KNIVES

Choose from a wide range of cutters and heavy duty knives. You will surely find the version that meets your needs.

- Snap-off blade
- Slide lock function

3 PCS/SET



18 mm

9 mm



spare blades  
KRT000402 - 18mm  
KRT000403 - 9mm

KRT000200

Blades  
18mm  
9mm



- Snap-off blade
- Auto lock function
- 1 extra blade
- Blade storage

18 mm



spare blades  
KRT000402



KRT000204

Blade  
18mm



- Snap-off blade
- Auto lock function
- Blade storage
- TPR rubber grip

9 mm



spare blades  
KRT000403



KRT000205

Blade  
9mm



- Snap-off blade
- Steel body

9 mm

spare blades  
KRT000403



KRT000201

Blade  
9mm



- Snap-off blade
- Auto lock function
- Blade storage
- TPR rubber grip

18 mm



spare blades  
KRT000402



KRT000206

Blade  
18mm



- Snap-off blade
- Auto lock function
- Stainless steel body

9 mm



spare blades  
KRT000403



KRT000202

Blade  
9mm



- Lock function
- Quick change blades
- 5 extra straight blades
- TPR rubber grip



spare blades  
KRT000400  
KRT000401

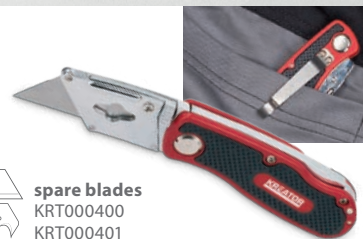

KRT000300

Blades  
Straight  
Hooked



- Snap-off blade
- Twist lock function
- 1 extra blade
- Blade storage

18 mm



spare blades  
KRT000402



KRT000203

Blade  
18mm



- Lock function
- Zinc alloy



spare blades  
KRT000400  
KRT000401



KRT000301

Blades  
Straight  
Hooked



- Snap-off blade
- Auto lock function
- Auto load
- 4 extra blades
- Blade storage



spare blades  
KRT000403

<b>KRT000302</b>	Blade 9mm	5 400338 055461 >
------------------	--------------	-------------------

- Snap-off blade
- Twist lock function



spare blades  
KRT000402

<b>KRT000303</b>	Blade 18mm	5 400338 055485 >
------------------	---------------	-------------------

- Snap-off blade
- Pencil sharpener
- Auto lock function
- Auto load
- 5 extra blades
- Blade storage



spare blades  
KRT000402

<b>KRT000304</b>	Blade 18mm	5 400338 055522 >
------------------	---------------	-------------------

- Lock function
- Rope cut
- Auto retractable
- Quick change blades
- 4 extra straight blades
- Blade storage



spare blades  
KRT000400  
KRT000401

<b>KRT000306</b>	Blades Straight Hooked	5 400338 055584 >
------------------	------------------------------	-------------------

- Lock Function
- Quick change blades
- 4 extra straight blades
- Blade storage



spare blades  
KRT000400  
KRT000401

<b>KRT000307</b>	Blades Straight Hooked	5 400338 055508 >
------------------	------------------------------	-------------------

- Lock and auto retract function
- Quick change blades
- Auto retractable
- 5 extra straight blades
- Blade storage
- Soft grip



spare blades  
KRT000400  
KRT000401

<b>KRT000308</b>	Blades Straight Hooked	5 400338 074233 >
------------------	------------------------------	-------------------

## SCRAPERS

Kreator introduces two hand scrapers for precision removal of burned remains from a stove or paint, glue, stickers, etc... from glass. With replaceable razor blade.

- Lock function
- Quick change blades
- 5 extra razor blades



spare blades  
KRT000404

<b>KRT000603</b>	Blade Razor	5 400338 055607 >
------------------	----------------	-------------------

- Use with 18mm snap-off blade
- Long handle

spare blades  
KRT000402



<b>KRT000604</b>	Blade 18mm	5 400338 055621 >
------------------	---------------	-------------------



## SPARE BLADES

Razor, straight or hooked. Kreator presents a variety of quality spare blades for all cutters and knives.

- 10 pcs straight blades
- SK-5 quality
- Blade length: 60mm



**10**  
PCS

**SK-5**



**KRT000400**

Blade  
Straight



- 10 pcs hooked blades
- SK-5 quality
- Blade length: 48mm



**10**  
PCS

**SK-5**



**KRT000401**

Blade  
Hooked



- 10 pcs 9mm blades
- SK-5 quality
- Blade length: 80mm



**10**  
PCS

**SK-5**

**9**  
mm



**KRT000403**

Blade  
9mm



- 10 pcs 18mm blades
- SK-5 quality
- Blade length: 100mm



**10**  
PCS

**SK-5**

**18**  
mm



**KRT000402**

Blade  
18mm



- 8 pcs razor blades
- SK-7 quality
- Blade length: 38mm



**8**  
PCS

**SK-7**



**KRT000404**

Blade  
Razor



## SCISSORS

A good pair of scissors surely is an indispensable cutting instrument in your tool box. Which one do you prefer?

- Stainless steel
- Thickness: 1.8mm



**1.8**  
mm  
THICKNESS

**140**  
mm

**170**  
mm

**216**  
mm

**3**  
PCS/  
SET

**KRT000505**

Size  
216mm  
170mm  
140mm



- Stainless steel
- Thickness: 1.8mm



**173**  
mm

**1.8**  
mm  
THICKNESS

**KRT000502**

Size  
173mm



- Stainless steel
- Thickness: 1.8mm



**190**  
mm

**1.8**  
mm  
THICKNESS

**KRT000503**

Size  
190mm



- Multi-purpose
- Thickness: 1.5mm



**215**  
mm

**1.5**  
mm  
THICKNESS

**KRT000501**

Size  
215mm



- Stainless steel
- Thickness: 2.0mm



**215**  
mm

**2.0**  
mm  
THICKNESS

**KRT000504**

Size  
215mm



## HEAVY DUTY SCISSORS

To cut thick or hard materials, those professional heavy duty scissors with stainless steel blades are just great.

- Professional quality
- Stainless steel
- Long nose
- Blade hardness: HRC53



**200 mm**  
**8"**



**KRT621001**

Size  
200mm  
8"



- Professional quality
- Stainless steel
- Max. cable size: Ø 10mm
- Blade hardness: HRC53

**10mm**  
**Ø**

**175 mm**  
**7"**



**KRT621002**

Size  
175mm  
7"



## HOBBY KNIVES

Compact and handy tools convenient for every handyman.

- Hand protection
- Ceramic polishing stone
- Tungsten steel blade
- PP housing



**15-in-1**



**KRT000902**

Size  
Small



**KRT001201**



- Razor sharp
- SK-7 quality

**SK-7**



**KRT000602**

Blade  
Razor



- Electrician knife



**KRT000901**



- Multi function 11-in-1
- Stainless steel
- Aluminium handle
- Open: 16cm  
Closed: 10.5cm

**11-in-1**



**KRT000903**

Size  
Large



- Multi function 11-in-1
- Stainless steel
- Aluminium handle
- Open: 10.8cm  
Closed: 7cm

**11-in-1**



**KRT000904**

Size  
Small





## TUBE CUTTERS

For fast, easy and clean tube cutting Kreator offers several options, depending on the diameter or material your pipe is made of.

- Professional quality
- Automatic withdrawal
- Polished Teflon blade
- Cuts aluminium, copper & PVC
- Blade hardness: HRC 56-58



<b>KRT000705</b>	Tube Ø 42mm	5 400338 059445 >
------------------	----------------	-------------------

- Polished Teflon blade
- Super sharp high quality blade
- Blade hardness: HRC 56-58



<b>KRT000706</b>	Tube Ø 42mm	5 400338 059452 >
------------------	----------------	-------------------

## GLASS CUTTERS

Starring Kreator's glass cutters, with small cutting wheel or diamond tip. They allow to create a score line where you want to part glass accurately and effectively.

- Basic glass cutter



**130 mm**

<b>KRT000801</b>	Size 130mm	5 400338 059391 >
------------------	---------------	-------------------

- Mini tube cutter



**Ø 3-16 mm**

<b>KRT000701</b>	Tube Ø 3-16mm	5 400338 059377 >
------------------	------------------	-------------------

- With deburrer



**Ø 3-28 mm**

<b>KRT000702</b>	Tube Ø 3-28mm	5 400338 059384 >
------------------	------------------	-------------------

- With deburrer
- Quick adjustment
- 96 Su blade



**Ø 6-35 mm**

<b>KRT000703</b>	Tube Ø 6-35mm	5 400338 059308 >
------------------	------------------	-------------------

- With deburrer
- Quick adjustment
- 96 Su blade



**Ø 6-42 mm**

<b>KRT000704</b>	Tube Ø 6-42mm	5 400338 059315 >
------------------	------------------	-------------------



- Diamond glass cutter



**170 mm**

<b>KRT000802</b>	Size 170mm	5 400338 059407 >
------------------	---------------	-------------------

## TILE CUTTERS

Simple to operate, the Kreator tile cutters are designed to quickly cut ceramic tiles to a desired shape or size.

- Disc size: Ø 15 x 6 x 1.5mm
- Max. width: 400mm
- Max. height: 10mm



**KRT001001**

Tile size  
400mm

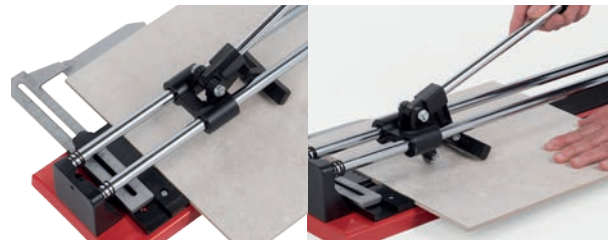

- **Professional quality**
- Extra side guide
- Disc size: Ø 22 x 6 x 2mm
- Max. width: 500mm
- Max. height: 14mm



**KRT001002**

Tile size  
500mm



## TAP & DIE SETS

Taps and dies are cutting instruments used to create threaded holes or rods into material. Depending on the sizes you need, you can choose for a 20 or 40 pieces set.

- Tap & die:
  - M3 x 0.5 / M4 x 0.7
  - M5 x 0.8 / M6 x 1.0
  - M7 x 1.0 / M8 x 1.25
  - M10 x 1.5 / M12 x 1.25
- 1/8" x NPT27
- 1x long handle
- 1x adjustable tap wrench
- 1x die handle

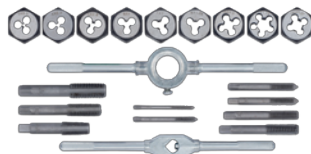

**20**  
PCS

**KRT001120**



- Tap & die:
  - M3 x 0.5 / M3 x 0.6
  - M4 x 0.7 / M4 x 0.75
  - M5 x 0.8 / M5 x 0.9
  - M6 x 0.75 / M6 x 1.0
  - M7 x 0.75 / M7 x 1.0
  - M8 x 1.0 / M8 x 1.25
  - M10 x 1.25 / M10 x 1.5
  - M12 x 1.25 / M12 x 1.5
- 1/8" x NPT27
- 1x long handle
- 1x adjustable tap wrench
- 1x T-handle tap wrench
- 1x die handle
- 1x screwdriver
- 1x screw pitch gauge



**40**  
PCS

**KRT001140**



# Saws

## HANDSAWS

Kreator presents a range of handsaws with 7 or 11 teeth per inch, for universal or fine cuts. Common saws for every self-respecting handyman who likes woodworking and carpentry.

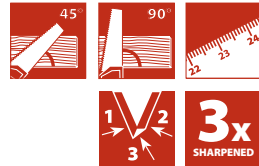

- Universal cut
- Hardened teeth
- 3-angle sharpened
- Soft grip TPR handle

<b>KRT801001</b>	Size 400mm 16"	TPI 7	
<b>KRT801002</b>	Size 450mm 18"	TPI 7	
<b>KRT801003</b>	Size 500mm 20"	TPI 7	
<b>KRT801004</b>	Size 550mm 22"	TPI 7	

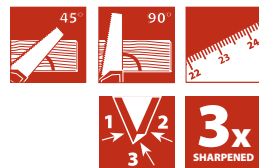

- Fine cut
- Hardened teeth
- 3-angle sharpened
- Soft grip TPR handle

<b>KRT801101</b>	Size 400mm 16"	TPI 11	
<b>KRT801102</b>	Size 500mm 20"	TPI 11	

## CONCRETE SAW

Discover this Kreator saw with carbide teeth, ideal for cellular concrete!

- 16x Carbide teeth
- Thickness: 1.6mm
- HM carbide tipped
- Soft grip TPR handle



<b>KRT810001</b>	Size 650mm 26"	TPI 1,5	
------------------	----------------------	------------	--

## MITRE SAWS + BOXES

Kreator introduces a selection of mitre saws and boxes to make accurate cross, bevel and mitre cuts in a workpiece.

- Universal cut
- Hardened teeth
- 2-angle sharpened
- Soft grip TPR handle



<b>KRT802001</b>	Size 350mm 14"	TPI 13	
------------------	----------------------	-----------	--

- Universal cut
- Hardened teeth
- 3-angle sharpened
- Soft grip TPR handle



- Box:
- Cutting angles: 45° and 90°
  - Inner width: 10cm



<b>KRT809001</b>	Size 350mm 14" 300mm 12"	TPI 9	
------------------	--------------------------------------	----------	--

- Cutting angles: 45° and 90°
- Inner width: 10cm
- 300 x 140 x 80mm



<b>KRT809002</b>	Size 300mm 12"	
------------------	----------------------	---

- Cutting angles: 22.5°, 45° and 90°
- Inner width: 9cm
- 300 x 100 x 80mm



<b>KRT809003</b>	Size 300mm 12"	
------------------	----------------------	---

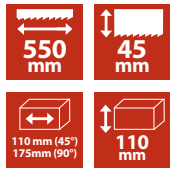

• Cutting angles:

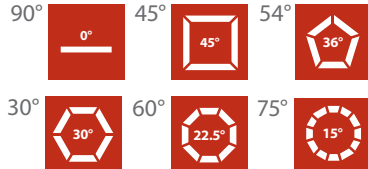

<b>KRT811001</b>	Size 550 x 120 x 400mm	TPI 14	
------------------	------------------------------	-----------	---



+ 1 blade for wood included

- 65Mn steel
- Thickness: 0.73mm
- Blade for wood

**For wood**



<b>KRT811002</b>	Size 550 x 45mm	TPI 14	
------------------	-----------------------	-----------	---

- 65Mn steel
- Thickness: 0.73mm
- Blade for metal

**For metal**



<b>KRT811003</b>	Size 550 x 45mm	TPI 24	
------------------	-----------------------	-----------	---

## WALLBOARD SAW

This small handsaw features a sharp point designed to cut quickly through wallboard and other synthetic building materials.

## COMPASS SAW

Useful for cutting holes when installing electrical boxes and pipes. This Kreator handsaw with a long narrow tapered blade is ideal to cut tight curves from the inner surface of drywall sheets.

- Hardened teeth
- 3-angle sharpened
- Soft grip TPR handle
- Thickness 1.2mm



<b>KRT808001</b>	Size 180mm 7"	TPI 7	
------------------	---------------------	----------	---

- Hardened teeth
- 3-angle sharpened
- Soft grip TPR handle
- Thickness 1.2mm



<b>KRT808002</b>	Size 300mm 12"	TPI 7	
------------------	----------------------	----------	---

## FRETSAW

Scared of curved cuts at extreme angles? Not with the thin narrow-bladed Kreator saw. With its fine teeth and deep tension frame, it's the ideal saw tool for fine woodcutting.

- Set of 12 blades
- T8 (S4) steel blades
- Thickness: 1mm



<b>KRT803002</b>	Size 130mm 5"	TPI 16	
------------------	---------------------	-----------	---

- 65Mn steel blade
- HRC 55 blade quality
- Wooden handle



<b>KRT803001</b>	Size 130mm 5"	TPI 16	
------------------	---------------------	-----------	---

## BOW SAWS

A rough metal-framed woodworking saw designed for cross-cutting branches or firewood down to size.

- Reinforced steel frame
- 3 blades:  
1x blade for wet wood  
2x metal blade for dry wood
- Protective handle

**300 mm  
12"**

1x 18TPI  
1x 24TPI



**KRT807001**

Size  
300mm  
12"



- 65Mn steel blade
- For wet wood

**For wet wood**



**KRT807002**

Size  
300mm  
12"



- Reinforced steel frame
- Protective soft griphandle
- Easy system to replace saw blades

**760 mm  
30"**



**KRT807201**

Size  
760mm  
30"



- 65Mn steel blade
- For dry wood

**For dry wood**



**KRT807202**

Size  
760mm  
30"



- 65Mn steel blade
- For wet wood

**For wet wood**



**KRT807203**

Size  
760mm  
30"



## METAL SAWS

Starring a range of Kreator metal saws. With different features, yet the same purpose: cut through metal quickly and effortlessly.

- Reinforced steel frame
- Protective soft grip handle
- Easy system to replace saw blades

**530 mm  
21"**



**KRT807101**

Size  
530mm  
21"



- 65Mn steel blade
- For dry wood

**For dry wood**



**KRT807102**

Size  
530mm  
21"



- 65Mn steel blade
- For wet wood

**For wet wood**



**KRT807103**

Size  
530mm  
21"



- High carbon steel blade
- 4 blade positions
- ABS plastic handle

**4 BLADE  
POSITIONS**

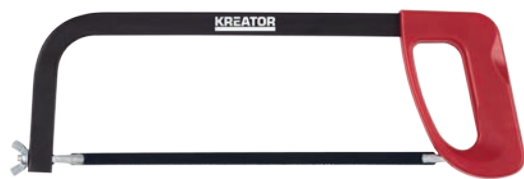

**KRT804005**

Size  
300mm  
12"

TPI  
24



- High carbon steel blade
- 4 blade positions
- Wooden handle

**4 BLADE  
POSITIONS**



**KRT804006**

Size  
300mm  
12"

TPI  
24



- Bi-metal blade
- 2 blade positions
- Soft grip TPR handle
- Easy use tension system to replace and tighten saw blades



<b>KRT804007</b>	Size 300mm 12"	TPI 24	5 400338 061363 >
------------------	----------------------	-----------	-------------------



- Bi-metal blade
- Aluminium frame
- 2 blade positions
- Soft grip TPR handle
- Design tension system to replace and tighten saw blades



<b>KRT804008</b>	Size 300mm 12"	TPI 24	5 400338 061356 >
------------------	----------------------	-----------	-------------------

## CROSS SAWS

Hard to reach workplaces are much less complicated to cut with a Kreator cross saw.

- Carbon steel blade
- Aluminium frame



<b>KRT805001</b>	Size 250mm 10"	TPI 24	5 400338 061295 >
------------------	----------------------	-----------	-------------------

- Bi-metal blade
- Soft grip TPR handle



<b>KRT805002</b>	Size 250mm 10"	TPI 24	5 400338 061370 >
------------------	----------------------	-----------	-------------------

## MINI SAWS

Good things come in small packages!  
The Kreator mini saws prove it.

- Junior saw
- Carbon steel blade
- Steel handle



<b>KRT804001</b>	Size 150mm 6"	TPI 24	5 400338 061288 >
------------------	---------------------	-----------	-------------------

- High carbon steel blade
- Wooden handle



<b>KRT804002</b>	Size 150mm 6"	TPI 24	5 400338 061325 >
------------------	---------------------	-----------	-------------------



- High carbon steel blade
- Aluminium frame
- Rubber handle



<b>KRT804003</b>	Size 150mm 6"	TPI 24	5 400338 061332 >
------------------	---------------------	-----------	-------------------



- SK4 steel blade
- Aluminium frame
- Soft grip TPR handle



<b>KRT804004</b>	Size 150mm 6"	TPI 24	5 400338 061301 >
------------------	---------------------	-----------	-------------------

## SPARE SAW BLADES

Of course the blades are also available separately.

- High carbon steel
- 5 pieces



**5**  
PCS

<b>KRT806001</b>	Size 150mm 6"	TPI 24	 5 400338 061387 >
------------------	---------------------	-----------	---

- SK4 steel
- 5 pieces

<b>KRT806002</b>	Size 150mm 6"	TPI 24	 5 400338 061318 >
------------------	---------------------	-----------	---



- Bi-metal
- 2 pieces

**2**  
PCS



<b>KRT806003</b>	Size 300mm 12"	TPI 24	 5 400338 061394 >
------------------	----------------------	-----------	---

- High carbon steel
- 2 pieces

<b>KRT806004</b>	Size 300mm 12"	TPI 24	 5 400338 061400 >
------------------	----------------------	-----------	---

## Notes

---

---

---

---

---

---

---

---

---

---

---

---

---

---

---

---

---

---

---

---

---

---

---

# Filing, grating & carving

## FILES

When cutting fine amounts of material from a workpiece use the Kreator files. They come in a wide variety of materials, sizes, shapes and cuts.

- Flat file
- T12 steel

- Soft grip TPR handle



**KRT451101**

Blade 200mm  
Total 315mm



- T12 steel
- Chainsaw file
- Diameter: 4.0mm

- Soft grip TPR handle



**KRT451105**

Blade 200mm  
Total 315mm



- Round file
- T12 steel

- Soft grip TPR handle



**KRT451102**

Blade 200mm  
Total 315mm



- T12 steel
- Chainsaw file
- Diameter: 4.8mm

- Soft grip TPR handle



**KRT451106**

Blade 200mm  
Total 315mm



- Half round file
- T12 steel

- Soft grip TPR handle



**KRT451103**

Blade 200mm  
Total 315mm



- 1x round file
- 1x flat file
- 1x half round file
- TPR handle



- Triangular file
- T12 steel

- Soft grip TPR handle



**KRT451104**

Blade 200mm  
Total 315mm



**KRT451000**

Blade 250mm  
Total 315mm



- High carbon chromium alloy steel
- Rubber handle



**KRT451200**

Blade 80mm  
Total 160mm



- T12 steel
- 1x round file
- 1x flat file
- 1x half round file
- Soft grip TPR handle



**KRT451107**

Blade 250mm  
Total 365mm





## WOOD RASPS

To remove wood rapidly discover this range of rasps with different shapes.

- A3 steel
- Flat wood rasp

- Soft grip TPR handle



**KRT453101**

Blade 200mm  
Total 315mm



- 1x round wood rasp
- 1x flat wood rasp
- 1x half round wood rasp
- TPR handle



**KRT453000**

Blade 200mm  
Total 315mm



- A3 steel
- Round wood rasp

- Soft grip TPR handle



**KRT453102**

Blade 200mm  
Total 315mm



- A3 steel
- 1x round wood rasp
- 1x flat wood rasp
- 1x half round wood rasp
- Soft grip TPR handle

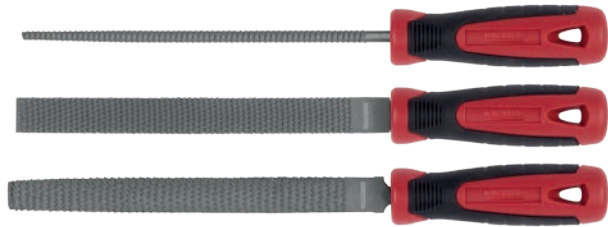

- A3 steel
- Half round wood rasp

- Soft grip TPR handle



**KRT453103**

Blade 200mm  
Total 315mm



**KRT453104**

Blade 200mm  
Total 315mm



## RASPS & BLOCK PLANES

For all finishing jobs within woodworking Kreator provides a wide selection of rasps and block planes.

- Lightweight synthetic body



**KRT454001**

Blade size  
60 x 40mm



- Diameter: 16mm
- Removable front grip
- Solid synthetic handle



**KRT454002**

Blade size  
250mm



- Lightweight synthetic body



**KRT454003**

Blade size  
140 x 40mm



- Lightweight synthetic body



**KRT454004**

Blade size  
250 x 40mm



- Aluminium lightweight body
- One hand operated



**KRT454005**

Blade size  
40 x 140mm



- Adjustable cutting depth
- Blade made of 65Mn-steel
- Blade width: 45mm



**KRT454007**

Size  
160mm



- Aluminium lightweight body
- Solid synthetic handle



**KRT454006**

Blade size  
40 x 250mm



- Adjustable alignment and cutting depth
- Blade made of 65Mn-steel
- Blade width: 45mm



**KRT454008**

Size  
235mm



## MODELLING & CARVING

Designed for precision modelling and carving tasks, these hobby knife sets allow impressive constructions and increase your carving possibilities.

- 8 pcs medium and heavy duty blades
- SK5 quality blade
- 2x aluminium blade holder

**10**  
PIECES



**KRT452001**

Pcs  
10



- Carving and woodworking
- Wooden handle

**6**  
PIECES



**KRT452003**

Size  
160mm



- 2x rubber coated blade holder
- 28 pcs wood carving blades
- SK5 quality
- Mini caliper
- Precision screwdriver
- Tweezers
- 2x puncture pins

**36**  
PIECES

**+ EXTRA PRECISION SCREWDRIVER**



**KRT452002**

Pcs  
36



## SCRIBERS

These sharp-pointed Kreator hand tools are conceived to mark lines on wooden or metal work pieces, prior to machining.

- High carbon steel
- Hooked scriber
- Double pointed



**KRT455001**

Size  
200mm



- Carbide tipped
- Pocket pen scriber



**KRT455002**

Size  
145mm



## SHARPENING STONES

Choose for the Kreator sharpening hand tools to sharpen the edges of scissors, knives, razors, chisels, hand scrapers or plane blades.

- Medium and fine grit



**KRT452004**

Size  
50 x 20 x 150mm



- Tungsten steel blades
- Ceramic polishing stone
- Hand protection
- PP housing



**KRT001201**



## Notes

---

---

---

---

---

---

---

---

---

---

---

---

---

---

---

---

---

---

---

---

---

---

---

---

---

# Measuring

## FOLDING RULERS

Easy to carry and fold out, these 2m Kreator rulers will fold where tapes won't bend. Feature in ABS or wood, with double sided print.

- Wood
- Double sided print
- MID Class III

2m



KRT701001

Size  
2m



- Top quality wood
- Double sided print
- MID Class III

2m



KRT701002

Size  
2m



- ABS material
- Double sided print
- MID Class III

2m



KRT701003

Size  
2m



## MEASURING TAPES

Kreator presents a variety of measuring tapes in durable fiberglass or steel. Those in steel are rigid enough to remain stiff when unrolled, yet pliable enough to roll up into the soft comfort grip housing.

- Soft grip coating
- MID Class II
- Blade width: 13mm

2m



KRT702002

Size  
2m



- Automatic lock
- Steel nylon coated tape
- Printed double sided
- MID Class II
- Blade width: 13mm

3m



KRT702103

Size  
3m



- Soft grip coating
- MID Class II
- Blade width: 13mm

3m



KRT702003

Size  
3m



- Automatic lock
- Magnetic double hook
- Steel nylon coated tape
- Printed double sided
- MID Class II
- Blade width: 16mm

5m



KRT702105

Size  
5m



- Soft grip coating
- MID Class II
- Blade width: 16mm

5m



KRT702005

Size  
5m



- Automatic lock
- Magnetic double hook
- Steel nylon coated tape
- Printed double sided
- MID Class II
- Blade width: 20mm

8m



KRT702108

Size  
8m



- Fiberglass
- MID Class III



**20m**

**KRT702020**

Size  
20m



- Long steel measuring tape
- MID Class III
- Strong ABS frame + steel handle



**50m**

**KRT702050**

Size  
50m



## LEVEL RULERS

Kreator offers aluminium rulers with integrated levels and metric scaling, in different lengths. They feature movable markers for easy frame hanging or other applications.

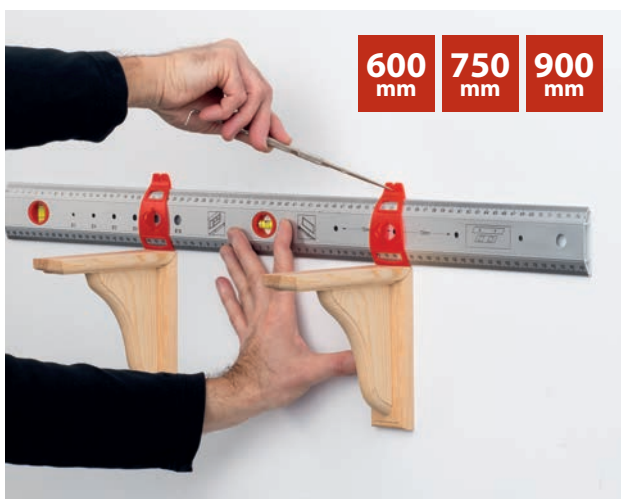

**600 mm** **750 mm** **900 mm**



- Reinforced aluminium
- 6 marking holes for drilling
- Vial levels 180° & 90°
- 2 adjustable markers



**KRT703600**

Size  
600mm



**KRT703750**

Size  
750mm



**KRT703900**

Size  
900mm



## TRY-SQUARES

Kreator introduces a range of highly accurate try-squares. Ideal for marking perfect right angles or checking a surface straightness in correspondence to another surface.



**250 mm** **300 mm** **350 mm**



- Full metal
- Metric scale on inside and outside

**KRT704025**

Size  
250mm



**KRT704030**

Size  
300mm



**KRT704035**

Size  
350mm



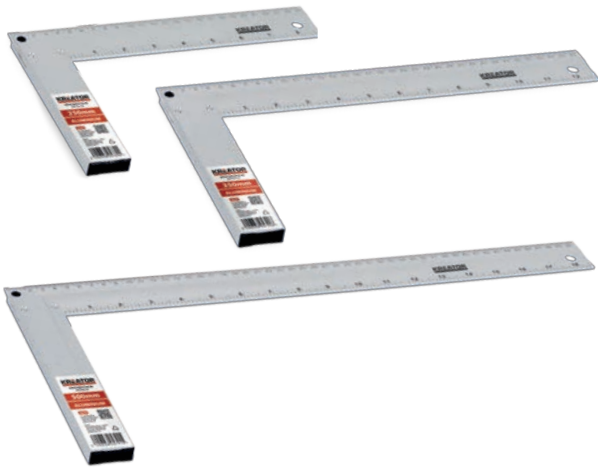

- Aluminium
- Metric & imperial scale

**250 mm** **350 mm** **500 mm**

<b>KRT704125</b>	Size 250mm	 5 400338 057892 >
<b>KRT704135</b>	Size 350mm	 5 400338 057908 >
<b>KRT704150</b>	Size 500mm	 5 400338 057915 >



- Angle of 45° or 90°
- Vial level
- Scriber

**300 mm**  **90°**  **45°**

<b>KRT704200</b>	Size 300mm	 5 400338 057953 >
------------------	---------------	--

## CALLIPERS

Kreator offers aluminium rulers with integrated levels and metric scaling, in different lengths. They feature movable markers for easy frame hanging or other applications.

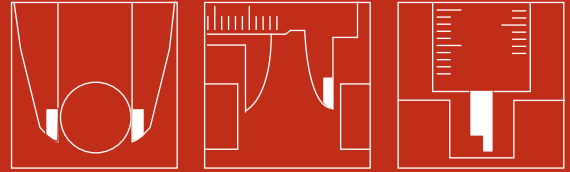

- Outer, inner & depth measurements
- Plastic

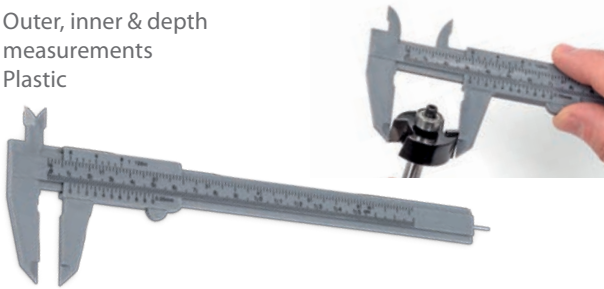

<b>KRT705001</b>	Size 150mm	 5 400338 057939 >
------------------	---------------	--

- Outer, inner & depth measurements
- Stainless steel



<b>KRT705003</b>	Size 150mm	 5 400338 057694 >
------------------	---------------	--

- Outer, inner & depth measurements
- Steel



<b>KRT705002</b>	Size 150mm	 5 400338 056918 >
------------------	---------------	--

- Outer, inner & depth measurements
- Stainless steel
- mm / inch
- 0.01mm accuracy
- 2 batteries incl.



<b>KRT705004</b>	Size 150mm	 5 400338 057700 >
------------------	---------------	--

## BRIDGE LEVELS

Starring the solid Kreator's bridge levels. They come with a steel frame and adjustable vial level.



- Heavy duty cast alu
- Vial levels 180° & 90°
- Adjustable vial level



**400 mm**   **500 mm**   **600 mm**

<b>KRT706040</b>	Size 400mm	5 400338 057830 >
<b>KRT706050</b>	Size 500mm	5 400338 057847 >
<b>KRT706060</b>	Size 600mm	5 400338 057854 >

## SPIRIT LEVELS

Designed to indicate whether a surface is horizontal or vertical. These Kreator spirit levels come with a magnetic stroke, measure top and shock absorbent end caps. Available in different sizes.



- Heavy duty cast alu frame
- Magnetic
- Vial levels 180°, 90° & 45°
- Shock absorbent end caps

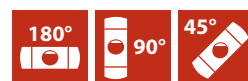

**600 mm**   **800 mm**   **1000 mm**   **1500 mm**

<b>KRT706160</b>	Size 600mm	5 400338 057793 >
<b>KRT706180</b>	Size 800mm	5 400338 057809 >
<b>KRT706100</b>	Size 1000mm	5 400338 057816 >
<b>KRT706150</b>	Size 1500mm	5 400338 057823 >

## TORPEDO LEVEL

Utilise Kreator's magnetic torpedo level to ensure that a surface or angle is level or plumbed properly. Conceived with three bubble vials to check multiple angles at a time.



- Angles of 180°, 90° or 45°
- Aluminium reinforced frame
- Strong magnetic frame



<b>KRT706001</b>	Size 230mm	5 400338 057946 >
------------------	------------	-------------------

## BEVEL SQUARE

This woodworker's tool features an adjustable arm opening to any angle. Useful to mark out an inclination of any size or to check the slope of a surface.



- Plastic handle
- Steel blade



<b>KRT707001</b>	Size 200mm	5 400338 057922 >
------------------	------------	-------------------

## CHALK LINES

Marking long, straight lines on rather flat surfaces is a piece of cake with the Kreator chalk lines. Furthermore, considering the pointed end of these models, they are appropriate as a plumb bob.



**3:1**  
CORD  
**30m**

- Fast retrieve 3:1
- Braided poly cord
- Easy fill
- Built-in handle



**KRT708002**



**POWDER**  
**115g**    **CORD**  
**30m**

- Rolling chalk line reel
- Dark blue top quality filling
- Mini vial level

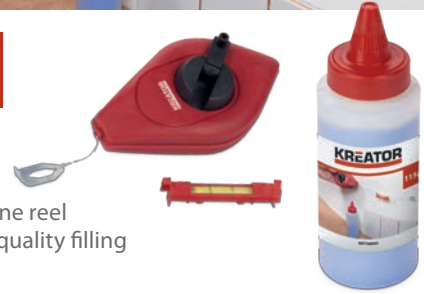

**KRT708001**



**POWDER**  
**115g**

- Dark blue top quality filling



**KRT708003**



## PLUMB BOB

While building a plumb wall or for door hanging, the Kreator plumb bob makes sure your constructions are vertical. Also the plumb line may be used as guide to align objects.

**200g**    **3m**  
cord

- Nylon cable
- Nickel plated steel



**KRT709001**



## PENCILS

Convenient for carpentry and masonry, Kreator pencils are indispensable in every do-it-yourself's toolbox!

**6**  
PCS

- 245mm
- Carpentry



**KRT710001**



**6**  
PCS

- 245mm
- Masonry



**KRT710002**



**10**  
PCS

- 177mm
- Carpentry

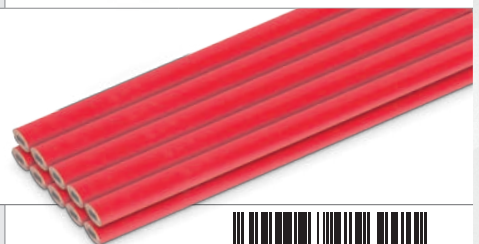

**KRT710003**





# KREATOR

## LASERS

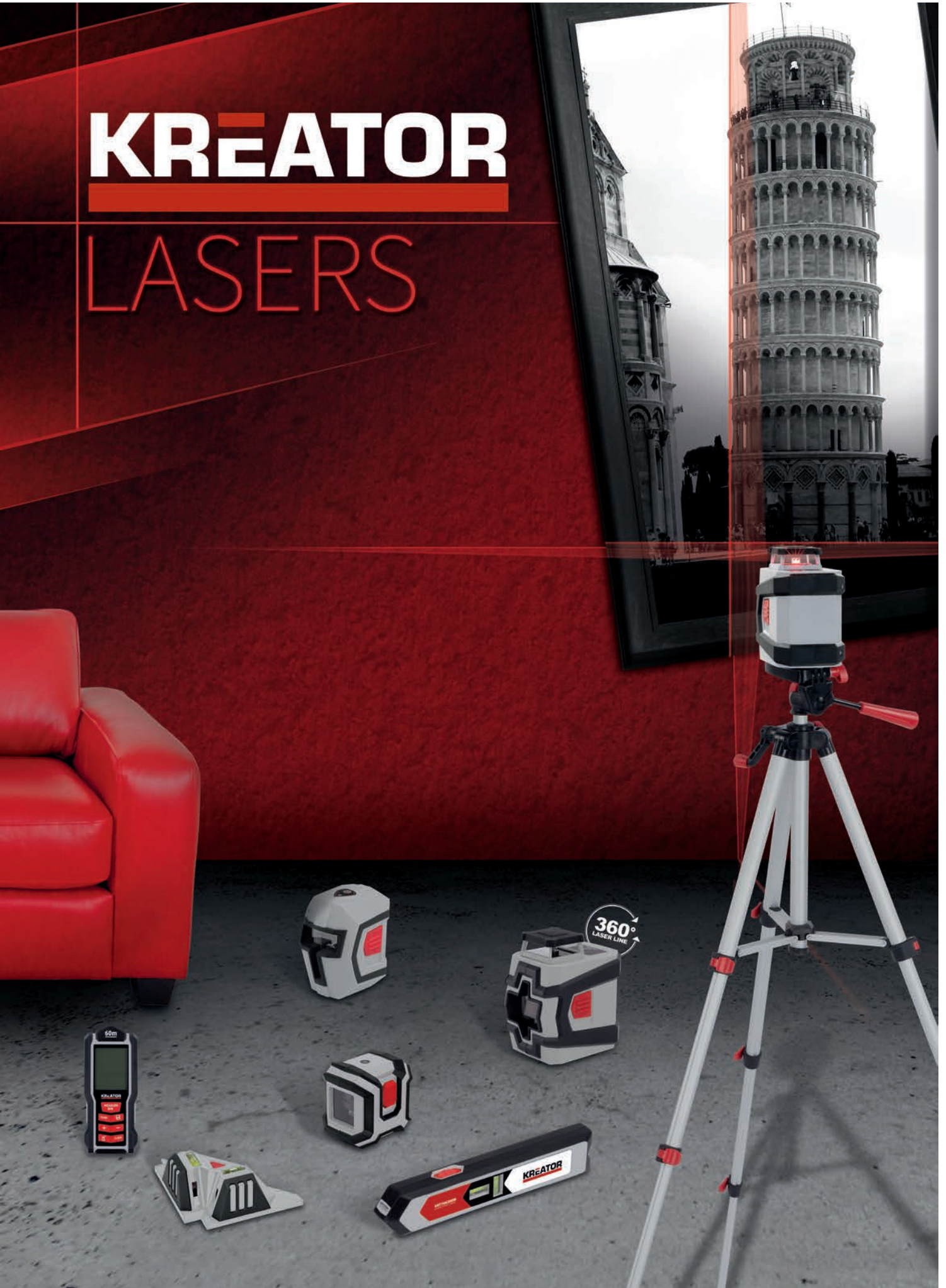

# Lasers

## LASER SPIRIT LEVEL

This laser can project a clear 3m line or mark a bright point on a wall that is even 20m further away. You can use the point and line laser for accurate vertical and horizontal levelling and alignment. For instance for hanging shelves, tiles, a collage of picture frames,... perfectly straight and in line. The laser clicks easily into the magnetic holder, that can be mounted on a tripod, attached to a wall or placed on a floor or table. An adjusting screw allows you to even put it on a surface that isn't completely flat, since you can slightly adapt the level of the holder. The laser is designed with a single button operation for ease of use.

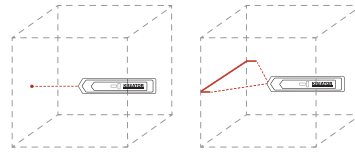

Magnetic wall holder



Duracell batteries  
2x AAA battery (1.5V)



KRT706200W



POWER	WORKING TIME	LASER WAVE LENGTH	LASER POWER	WORKING RANGE	LASER ACCURACY	LEVEL ACCURACY	WEIGHT EXCL. BATT.	DIMENSIONS
2x AAA Battery (1.5V)	>15h	LINE 635nm POINT 650nm	CLASS 2 <1mW	LINE 3m POINT 20m	LINE 1mm/m POINT 0.5mm/m	1mm/m	103g	165 x 23 x 33.5mm

## TILE LASER

This tile laser with magnetic wall holding plate is perfect for tiling floors and walls. It projects two bright laser lines at a 90° angle and up to 7m. It can be used for both straight and diagonal tiling. The laser has a T-edge and an L-edge on the sides, so you can use surrounding walls and corners for a quick and precise alignment.

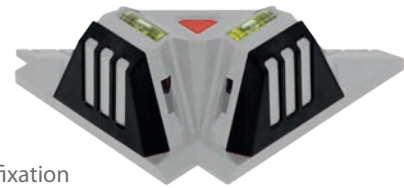
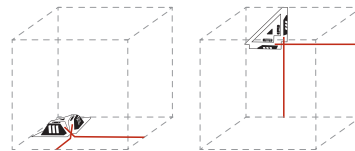

Wall fixation plate



Duracell batteries  
2x AA battery (1.5V)

KRT706205



POWER	WORKING TIME	LASER WAVE LENGTH	LASER POWER	WORKING RANGE	LASER ACCURACY	WEIGHT EXCL. BATT.	DIMENSIONS
2x AA Battery (1.5V)	>15h	635nm	CLASS 2 <1mW	7m	0.5mm	115g	160 x 84 x 84mm

## LASER DISTANCE METER

This digital laser is your perfect partner for measuring distances up to 60m with a 2.0mm accuracy. It does not only guarantee a precise measurement of length, but it can also automatically calculate area and volume for you. Indirect measurements are also possible with the Pythagorean equation. That way you can even determine distances if linear measurement isn't possible due to obstacles.

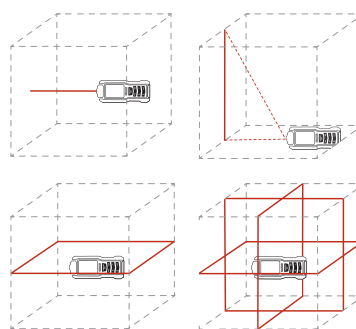
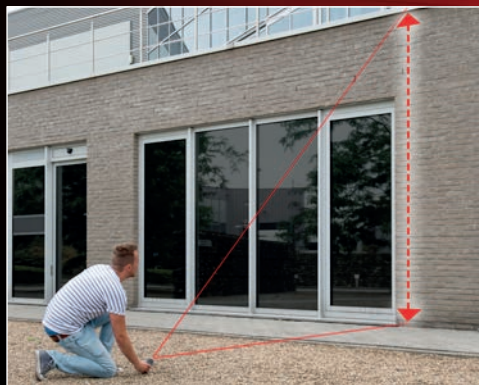

- 4 FUNCTIONS** Length / volume / area / Pythagorean measuring
- 2x AAA** Duracell batteries  
2x AAA battery (1.5V)

**KRT706215**



POWER	LASER WAVE LENGTH	LASER POWER	MEASURING RANGE	MEASURING ACCURACY	WEIGHT EXCL. BATT.	DIMENSIONS
2x AAA Battery (1.5V)	635nm	CLASS 2 <1mW	60m	±2.0mm	105g	52.8 x 127 x 26.3mm

## LEVELLING CROSS LASER

This self-levelling cross laser can project a cross-line, a separate horizontal line or a vertical laser line. The laser automatically levels itself in less than 5 seconds and with an accuracy of 0.5mm/m. A handy LED-indicator will let you know when the leveling is perfect for you to start working. The automatic levelling can be switched off if you prefer to work with a diagonal cross for example. With a single button operation you can easily switch between all modes. All these different options make this laser perfect for all sorts of levelling and alignment applications. Whether you like to tile the wall or hang up frames, pictures, shelves, lamps,... it is all possible with this cross laser with a working range of 10m. To protect the self-levelling laser during transport or storage, the off switch also securely locks the laser.

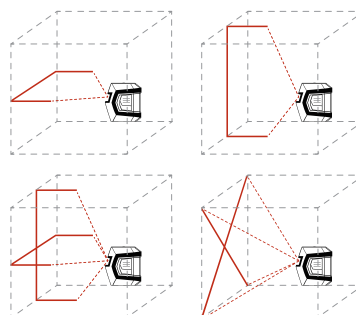

- Adjustable 1/4" tripod**  
Max.110cm
- 2x AA** Duracell batteries  
2x AA battery (1.5V)

**KRT706220T1**



POWER	WORKING TIME	LASER WAVE LENGTH	LASER POWER	WORKING RANGE	LASER ACCURACY	LEVEL ACCURACY	WEIGHT EXCL. BATT.	DIMENSIONS
2x AA Battery (1.5V)	>15h	650nm	CLASS 2 <1mW	10m	0.5mm/m	<5sec	261g	76.5 x 56 x 83.5mm

## MINI LEVELLING CROSS LASER

This self-levelling cross laser simultaneously projects a straight horizontal and vertical line making a clear and bright cross. It is perfect for levelling and alignment applications such as tiling walls, hanging up picture frames along one line,...

The cross lines automatically self-align in less than 5 seconds so you don't lose any time and can start working immediately. The cross laser has a 10m working range and a 0.5mm/m accuracy. It comes with a flexible clamp, so it can easily be fixed to a surface. The laser can also be mounted on a tripod.

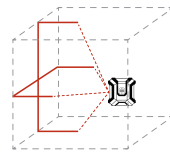

Adjustable 1/4" clamp



Duracell batteries  
2x AAA battery (1.5V)

KRT706225C



POWER	WORKING TIME	LASER WAVE LENGTH	LASER POWER	WORKING RANGE	LASER ACCURACY	LEVEL ACCURACY	WEIGHT EXCL. BATT.	DIMENSIONS
2x AAA Battery (1.5V)	>15h	635nm	CLASS 2 <1mW	10m	±0.5mm/m	<5sec	162g	65 x 65 x 56mm

## LEVELLING CROSS LASER

This cross laser has no less than 5 different modes to choose from. You can for instance project a 360° horizontal line. This allows you to line up an entire room from one setup point. You can also go for a horizontal or a vertical line with self-alignment or a cross-line with or without self-levelling. The last option makes it possible to use a diagonal cross. All these different options make this laser perfect for all sorts of levelling and alignment applications.

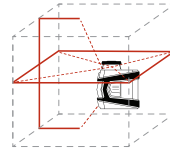
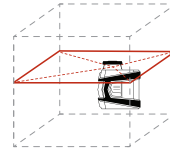
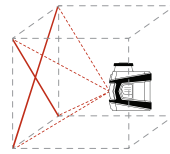
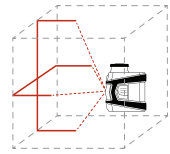
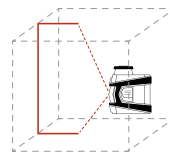
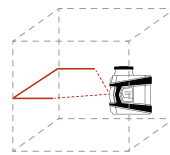

Adjustable 1/4" tripod  
Max.110cm



Duracell batteries  
4x AA battery (1.5V)

KRT706230T1



POWER	WORKING TIME	LASER WAVE LENGTH	LASER POWER	WORKING RANGE	LASER ACCURACY	LEVEL ACCURACY	WEIGHT EXCL. BATT.	DIMENSIONS
4x AA Battery (1.5V)	>15h	635nm	CLASS 2 <1mW	10m	0.5mm/m	<5sec	332.5g	90 x 69 x 111.1mm

# Spanners, wrenches & sockets

## SPANNERS

Kreator presents a range of spanners in stylish satin finish and elliptical design. Available as ring, combination, open-ended or ratchet ring spanners.

- Chrome vanadium
- DIN 3110
- Matt finish
- Elliptical shape

### DOUBLE OPEN SPANNERS



<b>KRT501001</b>	Length 120mm	Size 6 x 7	5 400338 062612 >
<b>KRT501002</b>	Length 130mm	Size 8 x 9	5 400338 062629 >
<b>KRT501003</b>	Length 150mm	Size 10 x 11	5 400338 062636 >
<b>KRT501004</b>	Length 165mm	Size 12 x 13	5 400338 062643 >
<b>KRT501005</b>	Length 175mm	Size 14 x 15	5 400338 062650 >
<b>KRT501006</b>	Length 190mm	Size 16 x 17	5 400338 062667 >
<b>KRT501007</b>	Length 205mm	Size 18 x 19	5 400338 062674 >
<b>KRT501008</b>	Length 225mm	Size 20 x 22	5 400338 062681 >
<b>KRT501009</b>	Length 250mm	Size 24 x 27	5 400338 062698 >
<b>KRT501010</b>	Length 260mm	Size 25 x 28	5 400338 062704 >
<b>KRT501011</b>	Length 280mm	Size 30 x 32	5 400338 062711 >

- Chrome vanadium
- DIN 838
- Matt finish
- Elliptical shape

### DOUBLE RING SPANNERS



<b>KRT501101</b>	Length 120mm	Size 6 x 7	5 400338 062728 >
<b>KRT501102</b>	Length 130mm	Size 8 x 9	5 400338 062735 >
<b>KRT501103</b>	Length 150mm	Size 10 x 11	5 400338 062742 >
<b>KRT501104</b>	Length 165mm	Size 12 x 13	5 400338 062759 >
<b>KRT501105</b>	Length 175mm	Size 14 x 15	5 400338 062766 >
<b>KRT501106</b>	Length 190mm	Size 16 x 17	5 400338 062773 >
<b>KRT501107</b>	Length 205mm	Size 18 x 19	5 400338 062780 >
<b>KRT501108</b>	Length 225mm	Size 20 x 22	5 400338 062797 >
<b>KRT501109</b>	Length 250mm	Size 24 x 27	5 400338 062803 >
<b>KRT501110</b>	Length 260mm	Size 25 x 28	5 400338 062810 >
<b>KRT501111</b>	Length 280mm	Size 30 x 32	5 400338 062827 >

## Notes

---



---



---

- Chrome vanadium
- DIN 3113
- Matt finish
- Elliptical shape

**COMBINATION SPANNERS**



<b>KRT501201</b>	Length 100mm	Size 6	5 400338 062834 >
<b>KRT501202</b>	Length 110mm	Size 7	5 400338 062841 >
<b>KRT501203</b>	Length 120mm	Size 8	5 400338 062858 >
<b>KRT501204</b>	Length 130mm	Size 9	5 400338 062865 >
<b>KRT501205</b>	Length 140mm	Size 10	5 400338 062872 >
<b>KRT501206</b>	Length 150mm	Size 11	5 400338 062889 >
<b>KRT501207</b>	Length 160mm	Size 12	5 400338 062896 >
<b>KRT501208</b>	Length 170mm	Size 13	5 400338 062902 >
<b>KRT501209</b>	Length 175mm	Size 14	5 400338 062919 >
<b>KRT501210</b>	Length 185mm	Size 15	5 400338 062926 >
<b>KRT501211</b>	Length 195mm	Size 16	5 400338 062933 >
<b>KRT501212</b>	Length 205mm	Size 17	5 400338 062940 >
<b>KRT501213</b>	Length 215mm	Size 18	5 400338 062957 >
<b>KRT501214</b>	Length 225mm	Size 19	5 400338 062964 >
<b>KRT501215</b>	Length 225mm	Size 20	5 400338 062971 >
<b>KRT501216</b>	Length 245mm	Size 21	5 400338 062988 >
<b>KRT501217</b>	Length 255mm	Size 22	5 400338 062995 >
<b>KRT501218</b>	Length 265mm	Size 23	5 400338 063008 >
<b>KRT501219</b>	Length 275mm	Size 24	5 400338 063022 >

<b>KRT501220</b>	Length 285mm	Size 25	5 400338 063039 >
<b>KRT501221</b>	Length 295mm	Size 26	5 400338 063046 >
<b>KRT501222</b>	Length 305mm	Size 27	5 400338 063053 >
<b>KRT501223</b>	Length 315mm	Size 28	5 400338 063060 >
<b>KRT501224</b>	Length 335mm	Size 30	5 400338 063077 >
<b>KRT501225</b>	Length 355mm	Size 32	5 400338 063084 >

**OPEN/RACHET RING SPANNERS**

- Chrome vanadium
- Satin finish
- Elliptical shape
- 72T



<b>KRT501301</b>	Length 135mm	Size 8	5 400338 063213 >
<b>KRT501302</b>	Length 154mm	Size 9	5 400338 063220 >
<b>KRT501303</b>	Length 154mm	Size 10	5 400338 063237 >
<b>KRT501304</b>	Length 167mm	Size 11	5 400338 063244 >
<b>KRT501305</b>	Length 178mm	Size 12	5 400338 063251 >
<b>KRT501306</b>	Length 178mm	Size 13	5 400338 063268 >
<b>KRT501307</b>	Length 192mm	Size 14	5 400338 063275 >
<b>KRT501308</b>	Length 207mm	Size 15	5 400338 063282 >
<b>KRT501309</b>	Length 207mm	Size 16	5 400338 063299 >
<b>KRT501310</b>	Length 222mm	Size 17	5 400338 063305 >
<b>KRT501311</b>	Length 222mm	Size 18	5 400338 063312 >
<b>KRT501312</b>	Length 238mm	Size 19	5 400338 063329 >
<b>KRT501313</b>	Length 240mm	Size 20	5 400338 063336 >

## SPANNER SETS

All sets come in a fine packaging for convenient storage and transport. You can hang them in your workshop or keep them altogether in your toolbox.



**8  
PCS**



- Chrome vanadium
- DIN 3110
- Matt finish
- Elliptical shape
- Tray:  
6 x 7, 8 x 9, 10 x 11, 12 x 13,  
14 x 15, 16 x 17, 18 x 19,  
20 x 22mm

**KRT500001**

Qty  
8 pcs



**8  
PCS**



- Chrome vanadium
- DIN 3110
- Matt finish
- Elliptical shape
- Pouch:  
6 x 7, 8 x 9, 10 x 11, 12 x 13,  
14 x 15, 16 x 17, 18 x 19,  
20 x 22mm

**KRT500010**

Qty  
8 pcs



**8  
PCS**



- Chrome vanadium
- DIN 838
- Matt finish
- Elliptical shape
- Tray:  
6 x 7, 8 x 9, 10 x 11, 12 x 13,  
14 x 15, 16 x 17, 18 x 19,  
20 x 22mm

**KRT500004**

Qty  
8 pcs



**8  
PCS**

- Chrome vanadium
- DIN 3110
- Matt finish
- Elliptical shape
- Window box:  
6 x 7, 8 x 9, 10 x 11, 12 x 13,  
14 x 15, 16 x 17, 18 x 19,  
20 x 22mm



**12  
PCS**

- Chrome vanadium
- DIN 3110
- Matt finish
- Elliptical shape
- Window box:  
6 x 7, 8 x 9, 10 x 11, 12 x 13,  
14 x 15, 16 x 17, 18 x 19,  
20 x 22, 21 x 23, 24 x 27,  
25 x 28, 30 x 32mm



**KRT500002**

Qty  
8 pcs



**KRT500003**

Qty  
12 pcs



**8  
PCS**

- Chrome vanadium
- DIN 838
- Matt finish
- Elliptical shape
- Window box:  
6 x 7, 8 x 9, 10 x 11, 12 x 13,  
14 x 15, 16 x 17, 18 x 19,  
20 x 22mm



**12  
PCS**

- Chrome vanadium
- DIN 838
- Matt finish
- Elliptical shape
- Window box:  
6 x 7, 8 x 9, 10 x 11, 12 x 13,  
14 x 15, 16 x 17, 18 x 19,  
20 x 22, 21 x 23, 24 x 27,  
25 x 28, 30 x 32mm



**KRT500005**

Qty  
8 pcs



**KRT500006**

Qty  
12 pcs





- Chrome vanadium
- DIN 3113
- Matt finish
- Elliptical shape
- Tray:  
8, 9, 10, 11, 13, 14, 17, 19mm

**8  
PCS**



**KRT500007**

Qty  
8 pcs



- Chrome vanadium
- Satin finish
- Elliptical shape
- Tray:  
10, 12, 13, 16, 17, 19mm

**6  
PCS**



**KRT500013**

Qty  
6 pcs



- Chrome vanadium
- Satin finish
- Elliptical shape
- Tray:  
8, 10, 12, 13, 17, 19mm

**6  
PCS**

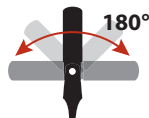

**KRT500014**

Qty  
6 pcs



**8  
PCS**

- Chrome vanadium
- DIN 3113
- Matt finish
- Elliptical shape

- Window box:  
8, 9, 10, 11, 13, 14, 17, 19mm



**12  
PCS**

- Chrome vanadium
- DIN 3113
- Matt finish
- Elliptical shape

- Window box:  
6, 7, 8, 9, 10, 11, 12, 13, 14, 17, 19, 22mm



**KRT500008**

Qty  
8 pcs



**KRT500009**

Qty  
12 pcs



**8  
PCS**

- Chrome vanadium
- DIN 3113
- Matt finish
- Elliptical shape

- Pouch:  
8, 9, 10, 11, 13, 14, 17, 19mm



**12  
PCS**

- Chrome vanadium
- DIN 3113
- Matt finish
- Elliptical shape

- Pouch:  
6, 7, 8, 9, 10, 11, 12, 13, 14, 17, 19, 22mm



**KRT500011**

Qty  
8 pcs



**KRT500012**

Qty  
12 pcs





## TUBULAR WRENCHES

Allows you to work in difficult and tight places where other wrenches just can't reach. To be used with or without T-handle.

- A3 steel
- 2-in-1 T-handle 150mm
- Chrome finish



**6  
PCS**

<b>KRT506003</b>	Size	
	8 x 9mm	
	10 x 11mm	
	12 x 13mm	
	14 x 15mm	
17 x 19mm		



- A3 steel
- Chrome finish

<b>KRT501401</b>	Size 9 x 10mm	
<b>KRT501402</b>	Size 12 x 13mm	
<b>KRT501403</b>	Size 16 x 17mm	
<b>KRT501404</b>	Size 21 x 23mm	

## RATCHET WRENCHES

Choose between the standard or professional model with 72 teeth to ratchet sockets.

- Carbon steel
- Satin finish
- 45T
- Rubber handle



**45T**

<b>KRT503001</b>	Size	
	1/4"	
<b>KRT503002</b>	Size	
	3/8"	
<b>KRT503003</b>	Size	
	1/2"	

- Chrome vanadium
- Satin finish
- 72T
- Soft grip TPR handle



**72T**

<b>KRT503004</b>	Size	
	1/4"	
<b>KRT503005</b>	Size	
	3/8"	
<b>KRT503006</b>	Size	
	1/2"	

**72T**  
**1/2"**



- Extendable ratchet handle
- Chrome vanadium
- Satin finish
- Range: 300-450mm
- 72T
- Soft grip TPR handle



<b>KRT503007</b>	Size 1/2"	
------------------	--------------	---

## SOCKETS

Whether you lost a socket or need one extra, Kreator can provide these separately.

**1/2"**

- Chrome vanadium
- Matt finish



KRT502001	Size 10mm	5 400338 063343 >
KRT502002	Size 11mm	5 400338 063350 >
KRT502003	Size 12mm	5 400338 063367 >
KRT502004	Size 13mm	5 400338 063374 >
KRT502005	Size 14mm	5 400338 063381 >
KRT502006	Size 15mm	5 400338 063398 >
KRT502007	Size 16mm	5 400338 063404 >
KRT502008	Size 17mm	5 400338 063411 >
KRT502009	Size 18mm	5 400338 063428 >
KRT502010	Size 19mm	5 400338 063435 >

KRT502011

Size 20mm



KRT502012

Size 21mm



KRT502013

Size 22mm



KRT502014

Size 23mm



KRT502015

Size 24mm



## UNIVERSAL JOINTS & ADAPTORS

Make it fit with these sets. They include the most common sizes suitable for a wide range of applications.

- Chrome vanadium
- Matt finish
- M 3/8" to F 1/4"
- M 3/8" to F 1/2"
- M 1/2" to F 3/8"
- M 1/4" to F 3/8"



**4**  
PIECES

KRT502101

Size 1/4" · 3/8" · 1/2"



- Chrome vanadium
- Matt finish



**3**  
PIECES

KRT502100

Size 1/4" · 3/8" · 1/2"



## SOCKET SETS

Starring a full selection of socket sets with ratchet for every type of handyman or job to be done.

**28**  
PCS

**72T**

**1/4"**



- Chrome vanadium
- Matt finish
- 13x socket 1/4": 4, 4.5, 5, 5.5, 6, 7, 8, 9, 10, 11, 12, 13, 14mm
- Extension bar 100mm
- 72T ratchet handle 1/4"

- 13x bit socket 1/4":
  - SL5.5, SL7
  - ⊕ PH1, PH2
  - ⊗ T10, T15, T20, T25, T30
  - H3, H4, H5, H6

KRT500115

Qty 28 pcs



**12  
PCS**



- Chrome vanadium
- Satin finish
- Extension bar 150mm
- 72T ratchet handle 3/8"
- 10x socket 3/8":  
10, 11, 12, 13, 14, 15, 17, 19,  
22, 24mm

**KRT500113**

Size  
3/8"



- Chrome vanadium
- Satin finish
- Extension bar 100mm
- 72T ratchet handle 1/4"
- 10x socket 1/4":  
4, 5, 6, 7, 8, 9, 10, 11, 12,  
13mm

**KRT500112**

Size  
1/4"



- Chrome vanadium
- Satin finish
- Extension bar 125mm
- 72T ratchet handle 1/2"
- 10x socket 1/2":  
10, 11, 12, 13, 14, 15, 17, 19,  
22, 24mm

**KRT500114**

Size  
1/2"



**9  
PCS**

**1/2"**



- Chrome vanadium
- Satin finish
- 9x socket 1/2":  
10, 11, 12, 13, 14, 15, 17, 19, 22mm

**KRT500111**

Qty  
9 pcs



**41  
PCS**

**1/4"**

**SAE**



- Carbon steel
- 23x bit socket 1/4":
  - ➔ SL5, SL6, SL7
  - ➕ PH1, PH2, PH3
  - ➕ PZ1, PZ2
  - ⊖ T10, T15, T20, T25, T27, T30, T40
  - H1.5, H2, H2.5, H3, H4, H5, H5.5, H6
- 7x socket 1/4":  
6, 7, 8, 9, 10, 11, 12mm
- 7x socket 1/4" SAE-type:
  - 3/16", 1/4", 5/16",  
11/32", 3/8", 7/16", 1/2"
- 24T flexible ratchet screwdriver
- ⚙️ Magnetic bit holder 60mm

**KRT500101**

Qty  
41 pcs



**40  
PCS**



**1/4"**

**3/8"**



- Chrome vanadium
- Satin finish
- 10x socket 1/4":  
4, 4.5, 5, 6, 7, 8, 9, 10, 11,  
12mm
- 4x socket 3/8":  
13, 14, 15, 16mm
- 20x bit:
  - ➔ SL4, SL5, SL6
  - ➕ PH1, PH2, PH2, PH3
  - ➕ PZ1, PZ2, PZ3
  - ⊖ T10, T15, T20, T25, T27, T30
  - H3, H4, H5, H6
- 1/4" to 3/8" adaptor
- Adjustable wrench
- Extension bar 3/8" 75mm
- Ratchet screwdriver
- Reversible stubby ratchet handle 1/4" & 3/8"
- ⚙️ Magnetic bit holder 60mm

**KRT500116**

Qty  
40 pcs



**16  
PCS**

**1/4"**



- Carbon steel
- Chrome plated
- 11x socket 1/4":  
4, 4.5, 5, 5.5, 6, 7, 8, 9, 10, 11, 12mm
- Cross bar
- Flexible handle
- Extension bar 50 & 150 mm
- Ratchet handle 1/4"

**KRT500102**

Qty  
16 pcs



**39  
PCS**

**1/4"**

**3/8"**

**SAE**



- Carbon steel
- Chrome plated
- 12x socket 1/4":  
4, 4.5, 5, 5.5, 6, 7, 8, 9,  
10, 11, 12, 13mm
- 12x socket 1/4" SAE-type:  
5/32", 3/16", 7/32", 1/4",  
9/32", 5/16", 11/32", 3/8",  
13/32", 7/16", 15/32", 1/2"
- 3x socket 1/4" (8PT.)  
SAE-type:  
1/4", 5/16", 3/8"
- 3x socket 3/8" SAE-type:  
9/16", 11/16", 3/4"
- 3x socket 3/8":  
14, 16, 17mm
- Extension bar 3/8"
- Spark plug socket 21mm
- Spinner handle
- Spin disc
- Ratchet handle 3/8"
- 1x adaptor M 1/4" to F 3/8"

**KRT500103**

Qty  
39 pcs



**24  
PCS**

**1/2"**



- Carbon steel
- Chrome plated
- 18x socket 1/2":  
10, 11, 12, 13, 14, 15, 16, 17, 18, 19, 20, 21, 22, 23, 24, 27, 30,  
32mm
- Universal joint
- Sliding T-bar
- Speeder handle
- Extension bar 120 & 240mm
- Ratchet handle 1/2"

**KRT500104**

Qty  
24 pcs



**22  
PCS**

**1/2"**



- Chrome vanadium
- Satin finish
- 15x socket 1/2":  
10, 11, 12, 13, 14, 15, 16, 17, 18, 19, 22, 24, 27, 30, 32mm
- 2x spark plug socket: 16 & 21mm
- Universal joint
- Extension bar 125 & 250mm
- 3-Way adaptor
- 72T ratchet handle 1/2"

**KRT500118**

Qty  
22 pcs



**46**  
PCS

**1/4"**



- Chrome vanadium
- Satin finish

- 21x bit socket 1/4":
  - SL4, SL5.5 /SL7
  - PH1, PH2, PH3
  - PZ1, PZ2, PZ3
  - T10, T15, T20, T25, T30, T40
  - H3, H4, H5, H6, H7, H8
- 13x socket 1/4":
  - 4, 4.5, 5, 5.5, 6, 7, 8, 9, 10, 11, 12, 13, 14mm
- 4x hex key wrench:
  - 1.27, 1.5, 2, 2.5mm
- Universal joint
- Sliding bar 115mm
- Flexible extension bar 150mm
- Spinner handle
- Hex adaptor 30mm
- Extension bar 50 & 100mm
- 72T ratchet handle 1/4"

<b>KRT500117</b>	Qty 46 pcs	5 400338 065057 >
------------------	---------------	-------------------

**77**  
PCS

**1/2"**

**1/4"**



- Chrome vanadium
- Satin finish

- 1/2" DRIVE**
  - 13x socket 1/2":
    - 10, 11, 12, 13, 14, 15, 17, 19, 22, 24, 27, 30, 32mm
  - 7x hex key wrench:
    - 1.5, 2, 2.5, 5, 6, 8, 10mm
  - 11x spanner:
    - 7, 8, 9, 10, 11, 12, 13, 14, 15, 17, 19mm
  - 4x flexible socket wrench:
    - 8-9mm, 10-11mm, 12-13mm, 14-15mm
  - Universal joint
  - Spark plug socket 21mm
  - Extension bar 125 & 250mm
  - 3-Way adaptor
  - 72T ratchet handle 1/2"
- 1/4" DRIVE**
  - 21x bit socket 1/4":
    - SL3, SL4, SL5.5, SL7
    - PH0, PH1, PH2, PH3
    - PZ1, PZ2, PZ3
    - T10, T15, T20, T25, T30
    - H2, H3, H4, H5, H6
  - 9x socket 1/4":
    - 4, 5, 6, 7, 8, 9, 10, 11, 12mm
  - Universal joint
  - Sliding bar 115mm
  - Extension bar 100mm
  - Bit holder
  - Hex adaptor 30mm
  - 72T ratchet handle 1/4"

<b>KRT500121</b>	Qty 77 pcs	5 400338 065095 >
------------------	---------------	-------------------

**80**  
PCS

**1/2"**

**1/4"**



- Chrome vanadium
- Satin finish

- 1/2" DRIVE**
  - 15x bit 1/2":
    - SL8/ SL10, SL12
    - PH3, PH4
    - PZ3, PZ4
    - T40, T45, T50, T55
    - H3, H4, H5, H6
  - 12x socket 1/2":
    - 14, 15, 16, 17, 18, 19, 20, 22, 24, 27, 30, 32mm
  - 9x spanner:
    - 8, 10, 11, 12, 13, 14, 17, 19, 22mm
  - Universal joint
  - Spark plug socket 16 & 21mm
  - Extension bar 125 & 250mm
  - Bit holder
  - 3-Way adaptor
  - 72T ratchet handle 1/2"
- 1/4" DRIVE**
  - 17x bit socket 1/4":
    - SL4, SL5.5, SL7
    - PH1, PH2
    - PZ1, PZ2
    - T8, T10, T15, T20, T25, T30
    - H3, H4, H5, H6
  - 13x socket 1/4":
    - 4, 4.5, 5, 5.5, 6, 7, 8, 9, 10, 11, 12, 13, 14mm
  - Universal joint
  - Sliding bar
  - Extension bar 50 & 100mm
  - Flexible extension bar
  - Spinner handle
  - 72T ratchet handle 1/4"

<b>KRT500120</b>	Qty 80 pcs	5 400338 065088 >
------------------	---------------	-------------------

**94  
PCS**

**1/2"**

**1/4"**



- Chrome vanadium
- Satin finish

**1/2" DRIVE**

- 15x bit 30mm:
  - SL8, SL10, SL12
  - PH3, PH4
  - PZ3, PZ4
  - T40, T45, T50, T55
  - H8, H10, H12, H14
- 18x socket 1/2": 10, 11, 12, 13, 14, 15, 16, 17, 18, 19, 20, 21, 22, 23, 24, 27, 30, 32mm
- 4x deep socket 1/2": 14, 15, 17, 19mm
- Universal joint
- Spark plug socket 16 & 21mm
- Extension bar 125 & 250mm
- Bit holder 5/16"
- 3-Way adaptor
- 72T ratchet handle 1/2"

**1/4" DRIVE**

- 17x bit socket 1/4":
  - SL4, SL5.5, SL7
  - PH1, PH2
  - PZ1, PZ2
  - T8, T10, T15, T20, T25, T30
  - H3, H4, H5, H6
- 13x socket 1/4": 4, 4.5, 5, 5.5, 6, 7, 8, 9, 10, 11, 12, 13, 14mm
- 8x deep socket 1/4": 6, 7, 8, 9, 10, 11, 12, 13mm
- 3x hex key wrench:
  - 1.5, 2, 2.5mm
- Universal joint
- Hex bit adaptor 30mm
- Sliding bar 115mm
- Extension bar 50 & 100mm
- Flexible extension bar
- Spinner handle
- 72T ratchet handle 1/4"

**KRT500119**

Qty  
94 pcs



**PIPE & NUT WRENCHES**

When great force is needed, the Kreator pipe and nut wrenches show up.



- Heavy duty carbon steel



- Nut wrench
- Chrome vanadium
- Range: 1/2" - 15/16"
- Release button
- Single hand operation
- Soft grip TPR handle



**KRT506004**

Range  
13 - 24mm



- Pipe wrench
- Chrome vanadium
- Range: 1/4" - 1"
- Release button
- Single hand operation
- Soft grip TPR handle



**KRT506005**

Range  
6 - 25mm



<b>KRT504001</b>	Size 200mm	Range < 40mm	5 400338 063558 >
<b>KRT504002</b>	Size 250mm	Range < 50mm	5 400338 063565 >
<b>KRT504003</b>	Size 300mm	Range < 70mm	5 400338 063572 >
<b>KRT504004</b>	Size 350mm	Range < 80mm	5 400338 063589 >
<b>KRT504005</b>	Size 450mm	Range < 90mm	5 400338 063596 >

## ADJUSTABLE WRENCHES

Standard or professional design with thermoplastic rubber handle for a better grip. The "jaw" allows the wrench to be used with different sizes of fasteners (nuts, bolts, ...)

- Carbon steel
- Metric scale



<b>KRT505001</b>	Size 150mm	Range < 18mm	5 400338 063602 >
<b>KRT505002</b>	Size 200mm	Range < 25mm	5 400338 063619 >
<b>KRT505003</b>	Size 250mm	Range < 27mm	5 400338 063626 >
<b>KRT505004</b>	Size 300mm	Range < 35mm	5 400338 063633 >



- Chrome vanadium
- Soft grip TPR handle
- Metric scale



<b>KRT505101</b>	Size 150mm	Range < 25mm	5 400338 063640 >
<b>KRT505102</b>	Size 200mm	Range < 30mm	5 400338 063657 >
<b>KRT505103</b>	Size 250mm	Range < 35mm	5 400338 063664 >
<b>KRT505104</b>	Size 300mm	Range < 40mm	5 400338 063671 >

## OTHER WRENCHES

More specific wrenches for more specific jobs, such as fixing a tap, Kreator's got it all.

- Basin wrench
- Chrome vanadium



<b>KRT506001</b>	Size 275mm	5 400338 063688 >
------------------	---------------	-------------------



- Multi wrench
- Chrome vanadium



<b>KRT506002</b>	Size 9 - 22mm	5 400338 063695 >
------------------	------------------	-------------------

## Notes

---



---



---



---



---



---

# Fastening & maintenance

## CLAMPS & HOLDERS

Depending on the job to be done, Kreator offers you a wide selection of clamps that hold and secure objects tightly together in the best possible way. That way any kind of movement or separation is prevented.



- Cast iron
- A3-steel
- Wooden handle



• Steel plated: 3.j165 x 14mm



- Cast iron
- A3-steel
- Soft grip TPR handle



• Steel plated: 6 x 25mm

<b>KRT552001</b>	Size 50 x 100mm	5 400338 064203 >
<b>KRT552002</b>	Size 50 x 150mm	5 400338 064210 >
<b>KRT552003</b>	Size 50 x 200mm	5 400338 064227 >
<b>KRT552004</b>	Size 50 x 250mm	5 400338 064234 >
• Steel plated: 5 x 26mm		
<b>KRT552005</b>	Size 120 x 300mm	5 400338 064241 >
<b>KRT552006</b>	Size 120 x 400mm	5 400338 064258 >
<b>KRT552007</b>	Size 120 x 500mm	5 400338 064265 >
<b>KRT552008</b>	Size 120 x 600mm	5 400338 064272 >
<b>KRT552009</b>	Size 120 x 800mm	5 400338 064289 >
<b>KRT552010</b>	Size 120 x 1000mm	5 400338 064296 >

<b>KRT552101</b>	Size 80 x 150mm	5 400338 064302 >
<b>KRT552102</b>	Size 80 x 200mm	5 400338 064319 >
<b>KRT552103</b>	Size 80 x 300mm	5 400338 064326 >
• Steel plated: 8 x 30mm		
<b>KRT552104</b>	Size 120 x 250mm	5 400338 064333 >
<b>KRT552105</b>	Size 120 x 300mm	5 400338 064340 >
<b>KRT552106</b>	Size 120 x 400mm	5 400338 064357 >
<b>KRT552107</b>	Size 120 x 500mm	5 400338 064364 >
<b>KRT552108</b>	Size 120 x 600mm	5 400338 064371 >
<b>KRT552109</b>	Size 120 x 800mm	5 400338 064388 >
<b>KRT552110</b>	Size 120 x 1000mm	5 400338 064395 >



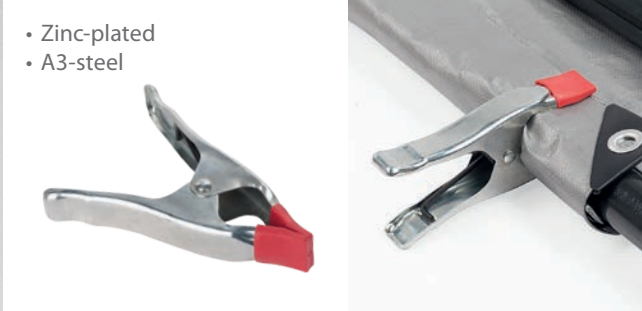

<b>KRT553001</b>	Qty 4 pcs	Size 150 mm	Clamping width 50mm	5 400338 064401 >
<b>KRT553002</b>	Qty 2 pcs	Size 170 mm	Clamping width 70mm	5 400338 064418 >



<b>KRT553003</b>	Qty 3 pcs	Size 70 90 120 mm	Clamping width 25mm 45mm 65mm	5 400338 064425 >
------------------	--------------	----------------------------	--	-------------------



<b>KRT553101</b>	Qty 4 pcs	Size 90 mm	Clamping width 40mm	5 400338 066450 >
<b>KRT553102</b>	Qty 2 pcs	Size 120 mm	Clamping width 50mm	5 400338 066467 >
<b>KRT553103</b>	Qty 2 pcs	Size 210 mm	Clamping width 95mm	5 400338 066474 >

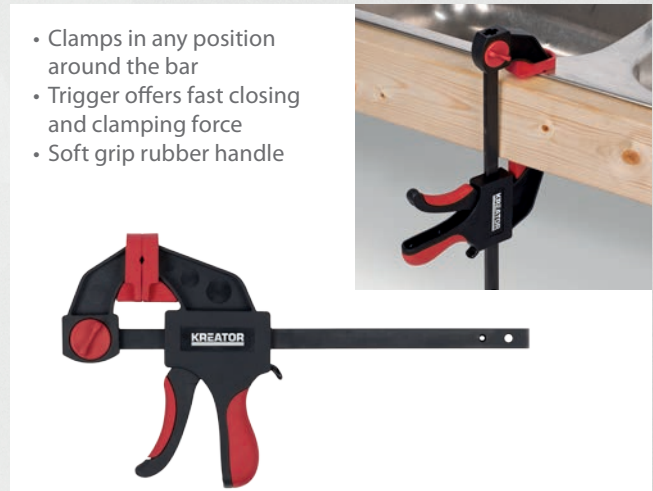

<b>KRT552201</b>	Clamping width 150mm	5 400338 066412 >
<b>KRT552202</b>	Clamping width 300mm	5 400338 066429 >
<b>KRT552203</b>	Clamping width 450mm	5 400338 066436 >
<b>KRT552204</b>	Clamping width 700mm	5 400338 066443 >



<b>KRT552301</b>	Length 4m	5 400338 066481 >
------------------	--------------	-------------------



<b>KRT552302</b>	Qty 1 pc	Size 220mm	5 400338 066498 >
<b>KRT552303</b>	Qty 2 pcs	Size 162mm 220mm	5 400338 066504 >

- Magnetic strength: 11.5kg
- 45° / 90° / 135°



**KRT552304**

Size  
82.5 x 120mm



- Cast aluminium construction
- Independently adjustable jaws



**KRT552305**



## RATCHET TIE DOWNS & CARRIER STRAPS

For optimal fastening during transportation, we present you a wide range of ratchet tie downs and carrier straps, as also a trailer net.

- Loading capacity: 100kg
- Breaking strength: 200kg
- GS certified

**5m**



**KRT555001**

Size  
25mm x 5m



- Loading capacity: 100kg
- Breaking strength: 200kg
- GS certified

**2.5m**

**2 PCS**



**KRT555002**

Size  
25mm x 2.5m



- Loading capacity: 135kg
- Breaking strength: 270kg
- GS certified

**5m**



**KRT555003**

Size  
25mm x 5m



- Loading capacity: 480kg
- Breaking strength: 960kg
- J-hooks
- GS certified

**5m**



**KRT555005**

Size  
25mm x 5m



- 2x bungee cord:  
Ø 8mm - 40cm / Ø 8mm - 60cm
- 2x buckle strap: 25mm  
- loading capacity: 100kg  
- breaking strength: 200kg
- 2x ratchet tie down: 25mm
- S-hooks:  
- loading capacity: 135kg  
- breaking strength: 270kg
- GS certified



**8 PCS**



**KRT555004**

Size  
Ø 8mm - 40cm  
Ø 8mm - 60cm  
25mm - 2.5m  
25mm - 3.5m



- Loading capacity: 225kg
- Breaking strength: 450kg
- S-hooks
- GS certified

**4.5m**



**KRT555006**

Qty  
2 pcs

Size  
25mm  
x 4.5m



**KRT555007**

Qty  
4 pcs

Size  
25mm  
x 4.5m



- Loading capacity: 1000kg
- Breaking strength: 2000kg
- J-hooks
- GS certified

**4.6m**

**9m**



<b>KRT555008</b>	Size 38mm x 4.6m	5 400338 066115 >
------------------	---------------------	-------------------

<b>KRT555009</b>	Size 38mm x 9m	5 400338 066122 >
------------------	-------------------	-------------------

- Rubber material
- Hooks and ball ending

**2 PCS**



<b>KRT555104</b>	Qty 2 pcs	Size Ø 8mm x 55cm	5 400338 066184 >
------------------	--------------	-------------------------	-------------------

- Rubber material
- Steel hooks
- GS certified



**2 PCS**



<b>KRT555101</b>	Qty 2 pcs	Size Ø 10mm x 100cm	5 400338 066153 >
------------------	--------------	---------------------------	-------------------

- Rubber material
- Steel hooks
- GS certified



**1 PC**



<b>KRT555105</b>	Qty 1 pc	Size Ø 8mm x 100cm	5 400338 066191 >
------------------	-------------	--------------------------	-------------------

- Rubber material
- Steel hooks
- GS certified



**4 PCS**

<b>KRT555102</b>	Qty 4 pcs	Size Ø 8mm x 100cm	5 400338 066160 >
------------------	--------------	--------------------------	-------------------

- Rubber material
- Ball ending

**10 PCS**



<b>KRT555106</b>	Qty 10 pcs	Size Ø 4mm x 25cm	5 400338 066207 >
------------------	---------------	-------------------------	-------------------

- Rubber material
- Steel hooks
- GS certified



**2 PCS**

<b>KRT555103</b>	Qty 2 pcs	Size Ø 8mm x 60cm	5 400338 066177 >
------------------	--------------	-------------------------	-------------------

- Wire: Ø 3mm
- Elastic cord surround: Ø 6mm
- PP-material
- Black zip bag included



<b>KRT555200</b>	Size 1.5 x 2.2m	5 400338 066603 >
------------------	--------------------	-------------------

## STRAPS

When fastening or securing thin or small objects, the Kreator straps come to hand. They are made of the strongest raw materials.



• UV resistant

<b>KRT556001</b>	Size 2.5 x 90mm	Qty 100 pcs	white	5 400338 065552 >
<b>KRT556002</b>	Size 3 x 120mm	Qty 100 pcs	white	5 400338 065569 >
<b>KRT556003</b>	Size 5 x 120mm	Qty 100 pcs	white	5 400338 065576 >
<b>KRT556004</b>	Size 5 x 190mm	Qty 50 pcs	white	5 400338 065583 >
<b>KRT556005</b>	Size 5 x 250mm	Qty 50 pcs	white	5 400338 065590 >
<b>KRT556006</b>	Size 8 x 300mm	Qty 25 pcs	white	5 400338 065606 >

<b>KRT556007</b>	Size 2.5 x 90mm	Qty 100 pcs	black	5 400338 065613 >
<b>KRT556008</b>	Size 3 x 120mm	Qty 100 pcs	black	5 400338 065620 >
<b>KRT556009</b>	Size 5 x 120mm	Qty 100 pcs	black	5 400338 065644 >
<b>KRT556010</b>	Size 5 x 190mm	Qty 50 pcs	black	5 400338 065705 >
<b>KRT556011</b>	Size 5 x 250mm	Qty 50 pcs	black	5 400338 065668 >
<b>KRT556012</b>	Size 8 x 300mm	Qty 25 pcs	black	5 400338 065675 >

- 75 pcs straps:
  - 25 pcs: 2.5 x 100mm
  - 25 pcs: 4.4 x 120mm
  - 25 pcs: 4.8 x 200mm



**75  
PCS**

- 75 pcs straps:
  - 25 pcs: 2.5 x 100mm
  - 25 pcs: 4.4 x 120mm
  - 25 pcs: 4.8 x 200mm
- UV resistant

<b>KRT556013</b>	Qty 75 pcs	white	5 400338 065682 >
<b>KRT556014</b>	Qty 75 pcs	black	5 400338 065699 >

## BENCH VICES

Our 360° swivel base vices include 2 lockdowns to secure your work position when utilising the swivel. They are made of cast iron for strength and durability. Ideal for general purpose and automotive applications.

- Cast iron swivel base (360°)
- Robust design and construction



**HEAVY  
DUTY** **360°**

<b>KRT554011</b>	Size 100mm	Weight 7.0kg	5 400338 075087 >
<b>KRT554012</b>	Size 125mm	Weight 10.5kg	5 400338 075094 >
<b>KRT554013</b>	Size 150mm	Weight 14.5kg	5 400338 075100 >

## GLASS SUCTION CUPS

Ideal for lifting glasses, sheet metals and any other smooth surfaces. Depending on the model, they can lift up from 50kg up to maximum 170kg.

- Capacity: 170kg
- Triplet drum
- Quick release handle



**KRT564003**

Size  
Ø 115mm



- Capacity: 50kg
- Single drum
- Quick release handle



**KRT564001**

Size  
Ø 115mm



- Capacity: 100kg
- Twin drum
- Quick release handle



**KRT564002**

Size  
Ø 115mm



## CAULKING GUNS

When sealing up gaps and cracks in your home, Kreator offers you 4 different caulking guns. All guns are crafted with heavy-duty steel to help ensure strength.

- Basic quality
- Nozzle clean-out tool included
- Iron trigger



**KRT551001**

Length  
225mm



- Standard quality
- Built-in spout cutter
- Nozzle clean-out tool included
- Soft grip rubber handle



**KRT551002**

Length  
225mm



- Professional quality
- Aluminium handle and iron trigger



**KRT551003**

Length  
225mm



- Professional quality
- Aluminium tube
- Aluminium handle and iron trigger
- For use with grease cartridges



- For use with sausage pack caulk/sealant

**KRT551004**

Length  
225mm



## PADLOCKS

When protecting your property from unauthorised use, theft, vandalism or even harm, the Kreator padlocks come at hand. Available in different weights, shapes and applications.

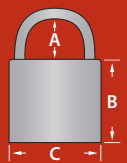

- Steel shackle
- Brass cylinder
- 3x iron key



<b>KRT557001</b>	A 13 mm	B 20 mm	C 20 mm	5 400338 065934 >
<b>KRT557002</b>	A 15 mm	B 25 mm	C 25 mm	5 400338 065941 >
<b>KRT557003</b>	A 18 mm	B 27 mm	C 30 mm	5 400338 065958 >
<b>KRT557004</b>	A 20 mm	B 33 mm	C 40 mm	5 400338 065965 >
<b>KRT557005</b>	A 27 mm	B 40 mm	C 50 mm	5 400338 065972 >

- Steel shackle
- Brass cylinder
- 3x iron key



<b>KRT557006</b>	A 23 mm	B 20 mm	C 20 mm	5 400338 065989 >
<b>KRT557007</b>	A 60 mm	B 32 mm	C 40 mm	5 400338 065996 >

- Professional quality
- Hardened solid steel body
- Steel shackle
- Brass cylinder
- 4x iron key



**HD**

<b>KRT557008</b>	A 23 mm	B 30 mm	C 40 mm	5 400338 066009 >
<b>KRT557009</b>	A 30 mm	B 42 mm	C 60 mm	5 400338 066016 >

- Steel shackle
- Brass cylinder
- 3 digits



<b>KRT557010</b>	A 27 mm	B 40 mm	C 28 mm	5 400338 066221 >
<b>KRT557011</b>	A 30 mm	B 50 mm	C 38 mm	5 400338 066238 >

- Professional quality
- Hardened solid steel body
- 3x iron key



**HD**



<b>KRT557012</b>	A 13 mm	B 75 mm	C 48 mm	5 400338 066023 >
------------------	---------------	---------------	---------------	-------------------

- Shielded shackle
- Case hardened steel shackle
- Stainless steel body
- 3x iron key

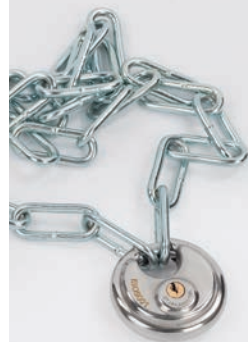

<b>KRT557013</b>	A 22 mm	B x C Ø 70 mm	5 400338 066030 >
------------------	---------------	---------------------	-------------------

## STAPLERS & TACKER

A collection of different powerful and durable staple guns for different DIY applications. Suitable for home decor, textiles, canvas, light duty repair and finishing.



- Lightweight high impact model
- Metal handle
- Easy drop in loading
- With reload indicator

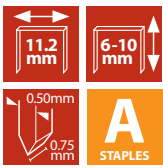

KRT000101



- Full metal robust construction
- Ergonomic handle
- Easy drop in loading
- With reload indicator
- Handle lock for easy storage

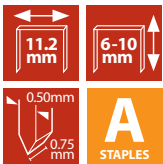

KRT000102



- Full metal robust construction
- Easy drop in loading
- With reload indicator
- Useful for staples and nails
- Ergonomic soft grip rubber handle
- Handle lock for easy storage



KRT000104



- Professional quality
- HD-steel construction for added durability
- Easy and fast reloading
- Ergonomic soft grip rubber handle absorbs all shocks and protects hand

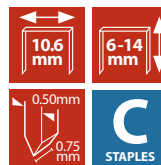

KRT000105



- Full metal robust construction
- Easy drop in loading
- With reload indicator
- Included 100 pcs: 4 - 14mm staples
- Ergonomic soft grip rubber handle
- Handle lock for easy storage

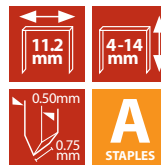

KRT000106



## Notes

---



---



---



---



---



---



---

# STAPLES & NAILS

Find out which staples/nails fit your power tool.

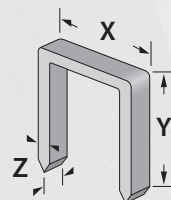
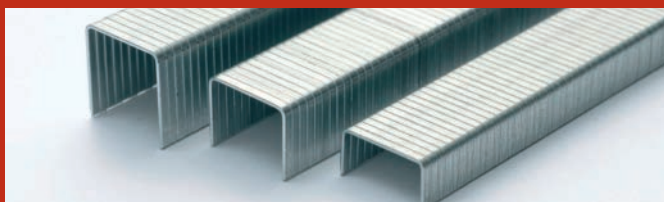

## A

### STAPLES TYPE A

1000 pcs

	Y: LENGTH	MATERIAL	X: CROWN	Z: WIRE SIZE
<b>KRT301006</b>	6mm	Zinc	11.2mm	0.50 x 0.75mm
<b>KRT301008</b>	8mm	Zinc	11.2mm	0.50 x 0.75mm
<b>KRT301010</b>	10mm	Zinc	11.2mm	0.50 x 0.75mm
<b>KRT301012</b>	12mm	Zinc	11.2mm	0.50 x 0.75mm
<b>KRT301014</b>	14mm	Zinc	11.2mm	0.50 x 0.75mm
<b>KRT301110</b>	10mm	Stainless Steel	11.2mm	0.50 x 0.75mm
<b>KRT301114</b>	14mm	Stainless Steel	11.2mm	0.50 x 0.75mm

## C

### STAPLES TYPE C

1500 pcs

<b>KRT303006</b>	6mm	Zinc	10.6mm	0.50 x 1.25mm
<b>KRT303008</b>	8mm	Zinc	10.6mm	0.50 x 1.25mm
<b>KRT303010</b>	10mm	Zinc	10.6mm	0.50 x 1.25mm
<b>KRT303012</b>	12mm	Zinc	10.6mm	0.50 x 1.25mm
<b>KRT303014</b>	14mm	Zinc	10.6mm	0.50 x 1.25mm

## D

### STAPLES TYPE D

1000 pcs

<b>KRT304016</b>	16mm	Zinc	6mm	1.10 x 1.20mm
<b>KRT304019</b>	19mm	Zinc	6mm	1.10 x 1.20mm
<b>KRT304022</b>	22mm	Zinc	6mm	1.10 x 1.20mm
<b>KRT304025</b>	25mm	Zinc	6mm	1.10 x 1.20mm
<b>KRT304030</b>	30mm	Zinc	6mm	1.10 x 1.20mm
<b>KRT304040</b>	40mm	Zinc	6mm	1.10 x 1.20mm
<b>KRT304120</b>	20mm	Stainless Steel	6mm	1.10 x 1.20mm
<b>KRT304130</b>	30mm	Stainless Steel	6mm	1.10 x 1.20mm
<b>KRT304140</b>	40mm	Stainless Steel	6mm	1.10 x 1.20mm

## A

### NAILS TYPE A

1500 pcs

<b>KRT305015</b>	15mm	Zinc	1.8mm	1.00 x 1.25mm
<b>KRT305020</b>	20mm	Zinc	1.8mm	1.00 x 1.25mm
<b>KRT305025</b>	25mm	Zinc	1.8mm	1.00 x 1.25mm
<b>KRT305030</b>	30mm	Zinc	1.8mm	1.00 x 1.25mm
<b>KRT305040</b>	40mm	Zinc	1.8mm	1.00 x 1.25mm
<b>KRT305050</b>	50mm	Zinc	1.8mm	1.00 x 1.25mm
<b>KRT305130</b>	30mm	Stainless Steel	1.8mm	1.00 x 1.25mm
<b>KRT305140</b>	40mm	Stainless Steel	1.8mm	1.00 x 1.25mm
<b>KRT305150</b>	50mm	Stainless Steel	1.8mm	1.00 x 1.25mm





REFERENCE	STAPLES	NAILS
<b>RAPID</b>		
R11	C 6 - 10mm	
R14	C 6 - 8mm	
R34	C 6 - 14mm	
R44	C 6 - 14mm	
R53	A 4 - 10mm	
R54	C 10 - 14mm	
R64	C 10 - 14mm	A 15mm
R83		A 15mm
R153	A 4 - 8mm	
R213		A 15 - 20mm
R253	A 6 - 14mm	
R353	A 6 - 14mm	
R453	A 6 - 14mm	A 15mm
R553	A 8 - 20mm	A 15 - 20mm
R606	D 12 - 25mm	A 15 - 25mm
Compacta	A 6 - 14mm	
CSN140	C 6 - 14mm	A 15mm
E-Tac	C 6 - 14mm	
ES130	C 6 - 14mm	A 15mm
ESN113		A 15mm
ESN114	C 6 - 14mm	A 15mm
ESN530	A 6 - 14mm	A 15mm
Handytacker	A 6 - 8mm	
MS03	A 4 - 8mm	
MS4.1	A 6 - 12mm	
MS610	A 4 - 10mm	
MS640	C 6 - 14mm	A 15mm
MS653	A 6 - 14mm	A 15mm
MS813		A 15mm
MS840	C 6 - 14mm	A 15mm
MS853	A 6 - 14mm	A 15mm
PN15-30		A 15 - 30mm
PN15-50		A 15 - 50mm
Pneumatic 18G		A 15 - 30mm
PS6-16	A 6 - 16mm	
PSN15-30	D 12 - 30mm	A 15 - 30mm
<b>BLACK &amp; DECKER</b>		
A5751	A 6 - 8mm	
A5752	A 6 - 14mm	
A5980	A 6 - 10mm	
BD428	D 15 - 30mm	
DN428	D 15 - 30mm	
KX428E	D 15 - 30mm	
Powershot	C 6 - 14mm	A 15mm
<b>BOSCH</b>		
HT8	A 4 - 8mm	
HT14	A 4 - 14mm	
HMT53	A 4 - 8mm	
HMT57	C 6 - 10mm	
PTK14E		A 15mm
PTK19	A 8 - 18mm	A 15 - 20mm
PTK23E	D 12 - 23mm	
PTK28E	A 12 - 20mm	
	D 12 - 15mm	

REFERENCE	STAPLES	NAILS
<b>STANLEY/BOSTITCH</b>		
ST10	A 6 - 10mm	
ST14	A 6 - 14mm	A 15mm
TR45	A 6 - 8mm	
TR100	C 6 - 14mm	
TR200	C 6 - 14mm	A 15mm
TRE500	C 6 - 14mm	A 15mm
Hobby 8/Pro 8	A 4 - 8mm	
Vario 14/HD 14	A 4 - 8mm	A 15mm
Pro 14	C 6 - 14mm	
Hammer Tacker	C 6 - 10mm	
T200/TRM100M2	C 6 - 14mm	
<b>METABO</b>		
TaE 1819/1919	D 12 - 18mm	A 20mm
TaA19	D 12 - 18mm	A 20mm
TaE 2019/2020	D 12 - 18mm	A 20mm
TaM 3030/3034	D 12 - 18mm	A 20mm
<b>POWERPLUS</b>		
POWAIR0310	D 16 - 32mm	A 15 - 32mm
POWAIR0311	D 16 - 40mm	A 15 - 50mm
POW734	A 8 - 16mm	A 15mm
POW737	A 8 - 16mm	A 15mm
POWX137	A 6 - 14mm	A 15mm
POWX138	D 6 - 25mm	A 32mm
<b>KREATOR</b>		
KRT000101	A 6 - 10mm	
KRT000102	A 6 - 10mm	
KRT000103	A 6 - 14mm	
KRT000104	A 6 - 14mm	A 15mm
<b>PIRANHA</b>		
70101	A 6 - 8mm	
70004	A 4 - 8mm	
70005/70006/70102	A 6 - 14mm	
<b>AIRPRESS</b>		
48129		A
45441/5		A
<b>ROCAFIX</b>		
MS03	A 4 - 8mm	
MS05	A 4 - 8mm	
MS10	A 6 - 12mm	
MS15	C 6 - 12mm	
MS20	A 6 - 12mm	
MS30	A 6 - 12mm	A 15mm
MS35	C 6 - 12mm	A 15mm
MS40	A 6 - 12mm	A 15mm
MS50	C 6 - 14mm	
MS100-MS110	A 4 - 10mm	
MS500	C 6 - 14mm	A 15mm
MS500B	A 6 - 14mm	A 15mm
ES130	C 6 - 14mm	A 15mm
ES230	A 6 - 14mm	A 15mm
EN330		A 15 - 30mm
PS12-25	D 12 - 25mm	
PN15-32		A 15 - 30mm
PN15-50		A 15 - 50mm
HS21	A 6 - 10mm	
HS50	C 6 - 10mm	
MS Metal	C 6 - 14mm	

# MAINTENANCE

Kreator offers a collection of products to clean any kind of surface and remove clogs in plumbing.

- Hanging hole for easy storage
- 6 rows
- Wooden handle
- Steel wires



**KRT561001**



- Hanging hole for easy storage
- 4 rows



• Steel wires

**KRT561002**



• Copper coated wires

**KRT561003**



• Stainless steel wires

**KRT561004**



- Hanging hole for easy storage
- Ergonomic soft grip rubber handle
- 4 rows



• Steel wires

**KRT561005**



• Copper coated wires

**KRT561006**



• Stainless steel wires

**KRT561007**



- Hanging hole for easy storage
- Pre-shaped ergonomic handle
- Copper coated wires



**KRT561008**



- 3 rows
- 1 stainless steel wire brush
- 1 copper wire brush
- 1 nylon wire brush



**KRT561102**

Qty  
3 pcs



- Hanging hole for easy storage
- 3 rows
- Ergonomic soft grip handle
- 1 stainless steel wire brush
- 1 copper wire brush
- 1 nylon wire brush



**KRT561101**

Qty  
3 pcs



- Foam sanding block
- 70 x 100mm



**KRT562001**

Grain  
60



**KRT562002**

Grain  
80



**KRT562003**

Grain  
1200



**KRT562004**

Grain  
240





- Diameter: 10mm
- High carbon steel with integrated boring head



<b>KRT563001</b>	Length 3m	5 400338 066344 >
<b>KRT563002</b>	Length 5m	5 400338 066351 >
<b>KRT563003</b>	Length 10m	5 400338 066368 >



- High carbon steel cable with integrated boring head



<b>KRT563004</b>	Length 5m	5 400338 066375 >
------------------	--------------	-------------------



- Quick, easy and safe to use
- PP and PVC
- 2x suction cup: Ø 68 - Ø 160mm



<b>KRT563005</b>	5 400338 066382 >
------------------	-------------------

## Notes

---



---



---



---



---



---



---



---



---



---



---



---



---



---



---



---



---



---



---



---



---



---



---



---



---



---



---



---

# Screwdrivers

## SCREWDRIVERS

Starring a variety of quality screwdrivers, shaped to fit any screw. Slotted, Pozi, Phillips, TX, ... you name it.

- Chrome vanadium
- Magnetic tip

### SLOTTED SCREWDRIVERS



<b>KRT401001</b>	Length 50mm	Type SL2.5	5 400338 058288 >
<b>KRT401002</b>	Length 75mm	Type SL3	5 400338 058295 >
<b>KRT401003</b>	Length 100mm	Type SL4	5 400338 058301 >
<b>KRT401004</b>	Length 100mm	Type SL5	5 400338 058318 >
<b>KRT401005</b>	Length 150mm	Type SL6	5 400338 058325 >
<b>KRT401006</b>	Length 150mm	Type SL8	5 400338 058332 >

- S2 steel
- Magnetic black tip



<b>KRT401101</b>	Length 50mm	Type SL2.5	5 400338 058349 >
<b>KRT401102</b>	Length 75mm	Type SL3	5 400338 058356 >
<b>KRT401103</b>	Length 100mm	Type SL4	5 400338 058363 >
<b>KRT401104</b>	Length 100mm	Type SL5	5 400338 058370 >
<b>KRT401105</b>	Length 150mm	Type SL6	5 400338 058387 >
<b>KRT401106</b>	Length 150mm	Type SL8	5 400338 058394 >
<b>KRT401107</b>	Length 200mm	Type SL10	5 400338 058400 >

- VDE 1000V
- Chrome vanadium
- Magnetic tip



<b>KRT401201</b>	Length 75mm	Type SL2.5	5 400338 058417 >
<b>KRT401202</b>	Length 75mm	Type SL3	5 400338 058424 >
<b>KRT401203</b>	Length 100mm	Type SL4	5 400338 058431 >
<b>KRT401204</b>	Length 125mm	Type SL5.5	5 400338 058448 >
<b>KRT401205</b>	Length 150mm	Type SL6.5	5 400338 058455 >

- Chrome vanadium
- Magnetic tip

### PHILLIPS SCREWDRIVERS



<b>KRT402001</b>	Length 75mm	Type PH0	5 400338 058462 >
<b>KRT402002</b>	Length 80mm	Type PH1	5 400338 058479 >
<b>KRT402003</b>	Length 100mm	Type PH2	5 400338 058486 >

- S2 steel
- Magnetic black tip



<b>KRT402101</b>	Length 75mm	Type PH0	5 400338 058493 >
<b>KRT402102</b>	Length 80mm	Type PH1	5 400338 058509 >
<b>KRT402103</b>	Length 100mm	Type PH2	5 400338 058516 >
<b>KRT402104</b>	Length 150mm	Type PH3	5 400338 058523 >

**STANDARD QUALITY**



**Chrome vanadium**  
Chrome plated

**PROFESSIONAL QUALITY**



**S2-steel**  
Satin finished

**VDE**



**Chrome vanadium**  
Isolated



- VDE 1000V
- Chrome vanadium
- Magnetic tip



- VDE 1000V
- Chrome vanadium
- Magnetic tip



<b>KRT402201</b>	Length 60mm	Type PH0	5 400338 058530 >
<b>KRT402202</b>	Length 80mm	Type PH1	5 400338 058547 >
<b>KRT402203</b>	Length 100mm	Type PH2	5 400338 058554 >

<b>KRT403201</b>	Length 60mm	Type PZ0	5 400338 058639 >
<b>KRT403202</b>	Length 80mm	Type PZ1	5 400338 058646 >
<b>KRT403203</b>	Length 100mm	Type PZ2	5 400338 058653 >

- Chrome vanadium
- Magnetic tip

**POZI  
SCREWDRIVERS**



- S2 steel
- Magnetic black tip

**TX  
SCREWDRIVERS**



<b>KRT403001</b>	Length 75mm	Type PZ0	5 400338 058561 >
<b>KRT403002</b>	Length 80mm	Type PZ1	5 400338 058578 >
<b>KRT403003</b>	Length 100mm	Type PZ2	5 400338 058585 >

<b>KRT404101</b>	Length 75mm	Type T6	5 400338 058660 >
<b>KRT404102</b>	Length 75mm	Type T7	5 400338 058677 >
<b>KRT404103</b>	Length 75mm	Type T8	5 400338 058684 >

- S2 steel
- Magnetic black tip



<b>KRT403101</b>	Length 75mm	Type PZ0	5 400338 058592 >
<b>KRT403102</b>	Length 80mm	Type PZ1	5 400338 058608 >
<b>KRT403103</b>	Length 100mm	Type PZ2	5 400338 058615 >
<b>KRT403104</b>	Length 150mm	Type PZ3	5 400338 058622 >

<b>KRT404104</b>	Length 75mm	Type T9	5 400338 058691 >
<b>KRT404105</b>	Length 75mm	Type T10	5 400338 058707 >
<b>KRT404106</b>	Length 100mm	Type T15	5 400338 058714 >
<b>KRT404107</b>	Length 100mm	Type T20	5 400338 058721 >
<b>KRT404108</b>	Length 100mm	Type T25	5 400338 058738 >
<b>KRT404109</b>	Length 100mm	Type T27	5 400338 058745 >
<b>KRT404110</b>	Length 100mm	Type T30	5 400338 058752 >

- S2 steel
- Magnetic black tip

**STUBBY SCREWDRIVERS**



<b>KRT405101</b>	Length 25mm	Type SL4	5 400338 058769 >
<b>KRT405102</b>	Length 25mm	Type SL6.5	5 400338 058776 >



<b>KRT405103</b>	Length 25mm	Type PH2	5 400338 058783 >
------------------	----------------	-------------	-------------------



<b>KRT405104</b>	Length 25mm	Type PZ2	5 400338 058790 >
------------------	----------------	-------------	-------------------

**VOLTAGE TESTERS**

Compact and handy, these pen style testers are appropriate to detect the presence of voltage and to test for proper grounding.



- Battery current indicator
- Light indication when current flow detected

**DC**  
6-12V **140**  
mm



<b>KRT409001</b>	Length 140mm	Voltage DC 6-12V	5 400338 059834 >
------------------	-----------------	------------------------	-------------------



**AWLS**

- S2 steel



<b>KRT406101</b>	Length 100mm	Type round	5 400338 058806 >
<b>KRT406102</b>	Length 100mm	Type square	5 400338 058813 >

- S2 steel
- Magnetic bit holder



<b>KRT407101</b>	Length 100mm	Type 6mm	5 400338 058820 >
------------------	-----------------	-------------	-------------------



**AC**  
100~  
250V **140**  
mm

- Light indication when current flow detected



<b>KRT409002</b>	Length 140mm	Voltage AC100- 250V	5 400338 059117 >
------------------	-----------------	---------------------------	-------------------

- Light indication when current flow detected

**AC**  
100~  
250V **190**  
mm



<b>KRT409003</b>	Length 190mm	Voltage AC100- 250V	5 400338 059124 >
------------------	-----------------	---------------------------	-------------------

## PRECISION SCREWDRIVERS

When accuracy is needed the precision screwdrivers fit in well. Small and narrow with a thin handle, ideal for precise jobs on small devices, such as computers, calculators, mobile phones, watches,...



- Chrome vanadium
- SL1, SL1.4, SL2, SL2.5
- PH0, PH1

**6**  
PCS

<b>KRT411001</b>	Qty 6 pcs	 5 400338 058240 >
------------------	--------------	---

- SL1, SL1.4, SL2, SL2.5, SL3, SL3.5

<b>KRT411002</b>	Qty 6 pcs	 5 400338 058257 >
------------------	--------------	---

- T5, T6, T7, T8, T9, T10

<b>KRT411003</b>	Qty 6 pcs	 5 400338 058264 >
------------------	--------------	---



- Chrome vanadium
- SL2, SL2.5, SL3
- PH#000, PH#00

**5**  
PCS

<b>KRT411004</b>	Qty 5 pcs	 5 400338 058837 >
------------------	--------------	---

## SCREWDRIVER SETS

Stock your toolbox with complete screwdriver sets. We offer sets from 6 to 44 pieces, including slot, Phillips, hex and TX. Many sets feature precision and stubby sizes.



- Chrome vanadium
- Screwdrivers:
  - SL4 75mm
  - SL5 100mm
  - PH1 75mm
  - PH2 100mm
  - PZ1 75mm
  - PZ2 100mm
-  Magnetic black tip

**6**  
PCS 

<b>KRT400001</b>	Qty 6 pcs	 5 400338 058844 >
------------------	--------------	---



- Chrome vanadium
- Screwdrivers:
  - SL4 75mm
  - SL5 100mm
  - SL6 125mm
  - SL8 150mm
  - PH0 75mm
  - PH1 100mm
  - PH2 125mm
-  Magnetic black tip

**7**  
PCS 

<b>KRT400002</b>	Qty 7 pcs	 5 400338 058851 >
------------------	--------------	---



- Chrome vanadium
- Screwdrivers:
  - SL4 75mm
  - SL5 100mm
  - SL6 125mm
  - SL8 150mm
  - PZ0 75mm
  - PZ1 100mm
  - PZ2 120mm
-  Magnetic black tip

**7**  
PCS 

<b>KRT400003</b>	Qty 7 pcs	 5 400338 058868 >
------------------	--------------	---

**44  
PCS**



- Chrome vanadium
- Screwdrivers:
  - SL3 75mm
  - SL5 75mm
  - SL8 150mm
  - ⊕ PH0 75mm
  - ⊕ PH1 75mm
  - ⊕ PH2 100mm
  - ⊕ PH3 150mm
- Precision:
  - T5, T6, T7, T8, T9, T10
  - SL2.5, SL3
  - ⊕ PH#00, PH#0
- Bits:
  - 4x slotted
  - ⊕ 4x phillips
  - ⊕ 2x pozi
  - 4x TX
  - 2x square
- Magnetic bit holder
- Adaptor
- Sockets 1/4":
  - 5, 6, 7, 8, 9, 10, 11, 12, 13mm
- Magnetic black tip

**KRT400004**

Qty / type  
44 pcs



**6  
PCS**



- Chrome vanadium
- VDE Screwdrivers:
  - SL3 75mm
  - SL4 100mm
  - ⊕ PH1 80mm
  - ⊕ PH2 100mm
  - ⊕ PZ1 80mm
  - ⊕ PZ2 100mm
- Magnetic black tip

**KRT400202**

Qty  
6 pcs



**7  
PCS**



- S2-steel
- 4x VDE screwdriver
  - SL4 100mm
  - SL5.5 125mm
  - ⊕ PH1 80mm
  - ⊕ PH2 100mm
- Voltage tester 190mm AC 125-250V~
- Diagonal pliers 150mm
- Long nose pliers 150mm
- Magnetic black tip

**KRT951101**

Qty  
7 pcs



**18  
PCS**



- Chrome vanadium
- Screwdrivers:
  - SL5 75mm
  - SL6 100mm
  - SL8 150mm
  - ⊕ PH1 75mm
  - ⊕ PH2 100mm
  - ⊕ PH3 150mm
- Stubby:
  - SL6 38mm
  - ⊕ PH2 38mm
- Precision:
  - T5, T6, T7, T8, T9, T10
  - SL2.5, SL3
  - ⊕ PH#00, PH#0
- Magnetic black tip

**KRT400005**

Qty  
18 pcs



**8  
PCS**



- Chrome vanadium
- VDE Screwdrivers:
  - SL3 75mm
  - SL4 100mm
  - SL5 125mm
  - SL6 150mm
  - ⊕ PH0 75mm
  - ⊕ PH1 100mm
  - ⊕ PH2 150mm
- Voltage tester 100-500V~

**KRT400201**

Qty  
8 pcs





26  
PCS



- Chrome vanadium
- 12x bit:
  - SL3, SL4, SL5 x2, SL6, SL7
  - ⊕ PH0, PH1 x2, PH2 x2, PH3
- 10x socket: 4, 5, 6, 7, 8, 9, 10, 11, 12, 13mm
- Extension bar 50mm
- Stubby ratchet handle 1/4"
- Socket adaptor 1/4"
- Magnetic adjustable ratchet screwdriver

KRT400006

Qty  
26 pcs



## SPECIAL SCREWDRIVERS

For special applications or 'hard to reach' screws, Kreator offers you different sets that will help you.



• Socket not included

- Chrome vanadium
- Bits:
  - SL6, SL8
  - ⊕ PH2, PH3



KRT410002

Qty  
4 pcs



18  
PCS



- Chrome vanadium
- Bits:
  - SL2, SL2.5, SL3, SL4
  - ⊕ PH00, PH0, PH1, PH2
  - T4, T5, T6, T7, T8, T9, T10, T15
- Extension bar 120mm
- Magnetic ratchet screwdriver

KRT400007

Qty / type  
18 pcs



- Chrome vanadium
- Impact screwdriver A3 steel
- Aluminium box
- Bits:
  - SL6, SL8
  - ⊕ PH2, PH3

• Socket included



KRT410003

Qty  
4 pcs



38  
PCS



- Chrome vanadium
- Ratchet screwdriver
- Bits:
  - SL2, SL2.5, SL3, SL4, SL5, SL5.5, SL6
  - ⊕ PH0 x2, PH1 x2, PH2 x2, PH3
  - ⊕ PZ0, PZ1, PZ2, PZ3
  - ⊕ T10, T15, T20, T30
  - T10, T15, T20, T25, T30, T40
  - H2, H2.5, H3, H4, H5, H5.5, H6
  - S1, S2
- Magnetic

KRT400008

Qty  
38 pcs



21  
PCS



- Chrome vanadium
- T-Handle bit
- Sockets: 5, 6, 7, 8, 9, 10, 11, 12, 13mm
- Bits:
  - SL3, SL4, SL5, SL6, SL8
  - ⊕ PH0, PH1, PH2,
  - T15, T20, T30
- Socket adaptor
- Magnetic

KRT410001

Qty  
21 pcs



- Chrome vanadium
- Bits:
  - SL3, SL4, SL5
  - ⊕ PZ0, PZ1, PZ2



KRT410004

Qty  
3 pcs



**7** PCS **480** mm 

- Telescopic pick-up screwdriver
- Chrome vanadium
- Extends to 480mm
- Bits:
  - SL5, SL6
  - ⊕ PH1, PH2, PH3
  - T15, T20
  - Magnetic



**KRT410005**

Qty  
7 pcs



**16-in-1**



- Chrome vanadium
- Stubby screwdriver
- Ratchet screwdriver
- Bits:
  - SL3, SL4, SL5
  - ⊕ PH1, PH2, PH3
- Ratchet folding
- Hex key:
  - 1.5, 2, 2.5, 3, 4, 4.5, 5, 5.5, 6mm

**KRT410006**

Qty  
16 pcs



## HEX KEYS

Kreator offers a wide collection of hex key sets that are conceived to drive screws and bolts with hexagon socket head.

**8** PCS 

- Chrome vanadium
- Hex key:
  - 1.5, 2, 2.5, 3, 4, 5, 5.5, 6mm



**KRT408001**

Qty  
8 pcs



**8** PCS 

- Chrome vanadium
- Hex key:
  - 2, 2.5, 3, 4, 5, 6, 8, 10mm



**KRT408002**

Qty  
8 pcs



**8** PCS 

- Chrome vanadium
- Hex key:
  - 1.5, 2, 2.5, 3, 4, 5, 6, 8mm



**KRT408101**

Qty  
8 pcs



**8** PCS 

- Chrome vanadium
- Hex key:
  - 1.5, 2, 2.5, 3, 4, 5, 6, 8mm



**KRT408201**

Qty  
8 pcs



**8** PCS 

- Chrome vanadium
- Hex key ball point:
  - 2.5, 3, 4, 5, 6, 7, 8, 10mm

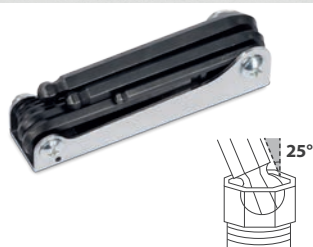

**KRT408102**

Qty  
8 pcs



**8** PCS 

- Chrome vanadium
- Hex key ball point:
  - 1.5, 2, 2.5, 3, 4, 5, 6, 8mm



**KRT408202**

Qty  
8 pcs



**8 PCS** 

- Chrome vanadium
- Security tamper TX
- TX key:
  - ⊕ T9, T10, T15, T20, T25, T27, T30, T40



<b>KRT408103</b>	Qty 8 pcs	 5 400338 058172 >
------------------	--------------	---

**8 PCS** 

- Chrome vanadium
- Security tamper TX
- TX key:
  - ⊕ T9, T10, T15, T20, T25, T27, T30, T40



<b>KRT408203</b>	Qty 8 pcs	 5 400338 058202 >
------------------	--------------	---

**EXTRA LONG HEX KEY**



**9 PCS** 

- Chrome vanadium
- Extra long hex key:
  - 1.5, 2, 2.5, 3, 4, 5, 6, 8, 10mm
- Length 10mm hex key: 23cm



<b>KRT408301</b>	Qty 9 pcs	 5 400338 058219 >
------------------	--------------	---



**9 PCS** 

- Chrome vanadium
- Hex key:
  - 1.5, 2, 2.5, 3, 3.5, 4, 5, 5.5, 6mm



<b>KRT408401</b>	Qty 9 pcs	 5 400338 058127 >
------------------	--------------	---

**9 PCS** 

- Chrome vanadium
- Extra long hex key ball point:
  - 1.5, 2, 2.5, 3, 4, 5, 6, 8, 10mm
- Length 10mm hex key: 23cm



<b>KRT408302</b>	Qty 9 pcs	 5 400338 058226 >
------------------	--------------	---



**8 PCS** 



<b>KRT410007</b>	Qty 8 pcs	 5 400338 058073 >
------------------	--------------	---

**9 PCS** 

- Chrome vanadium
- Security tamper TX
- Extra long hex key:
  - ⊕ T10, T15, T20, T25, T27, T30, T40, T45, T50
- Length T50 key: 23cm



<b>KRT408303</b>	Qty 9 pcs	 5 400338 058233 >
------------------	--------------	---

# Hammers

## MACHINIST HAMMERS

Used in metalworking, this square bevelled face and angular cross pein hammer is presented in different weights, quality and configurations. Our favourite one is the long life graphite model.

- Hardened tempered head with bevelled corners
- Oak wood handle
- Red dipped handle
- C45 forged steel



<b>KRT901001</b>	Weight 100g	5 400338 063749 >
<b>KRT901002</b>	Weight 200g	5 400338 063756 >
<b>KRT901003</b>	Weight 300g	5 400338 063763 >
<b>KRT901004</b>	Weight 400g	5 400338 063770 >

- Hardened tempered head with bevelled corners
- Oak wood handle
- Red dipped handle
- C45 forged steel
- Handle protection



<b>KRT901005</b>	Weight 500g	5 400338 063787 >
<b>KRT901006</b>	Weight 600g	5 400338 063794 >
<b>KRT901007</b>	Weight 750g	5 400338 063800 >
<b>KRT901008</b>	Weight 1000g	5 400338 063817 >

- Hardened tempered head with bevelled corners
- Fibreglass shank
- Ergonomic soft grip TPR handle



<b>KRT901101</b>	Weight 100g	5 400338 063824 >
<b>KRT901102</b>	Weight 200g	5 400338 063831 >

<b>KRT901103</b>	Weight 300g	5 400338 063848 >
<b>KRT901104</b>	Weight 400g	5 400338 063855 >
<b>KRT901105</b>	Weight 500g	5 400338 063862 >
<b>KRT901106</b>	Weight 600g	5 400338 063879 >
<b>KRT901107</b>	Weight 750g	5 400338 063886 >
<b>KRT901108</b>	Weight 1000g	5 400338 063893 >

- Hardened tempered head with bevelled corners
- Graphite shank
- Ergonomic soft grip TPR handle
- Maximum solidity

**GRAPHITE**



<b>KRT901201</b>	Weight 300g	5 400338 063909 >
<b>KRT901202</b>	Weight 500g	5 400338 063916 >

## STONING HAMMERS

Available with wooden or fibreglass shank, these heavyweight Kreator stoning hammers are conceived for the heavy duty hammer work.

- Hardened tempered head with bevelled corners
- Oak wood handle
- Red dipped handle
- C45 forged steel
- Handle protection



<b>KRT902001</b>	Weight 1000g	5 400338 063923 >
<b>KRT902002</b>	Weight 1250g	5 400338 063930 >
<b>KRT902003</b>	Weight 1500g	5 400338 063947 >
<b>KRT902004</b>	Weight 2000g	5 400338 063954 >

- Hardened tempered head with bevelled corners
- Fibreglass shank
- Ergonomic soft grip TPR handle



<b>KRT902101</b>	Weight 1000g	 5 400338 063961 >
<b>KRT902102</b>	Weight 1250g	 5 400338 063978 >
<b>KRT902103</b>	Weight 1500g	 5 400338 063985 >
<b>KRT902104</b>	Weight 2000g	 5 400338 063992 >

## CLAW HAMMERS

An essential carpentry tool perfect for driving nails or removing nails from a surface.

- Hardened tempered head with bevelled corners
- Oak wood handle
- Red dipped handle



<b>KRT903001</b>	Weight 450g	 5 400338 064005 >
------------------	----------------	-----------------------

- Hardened tempered head
- Tubular metal shank
- TPR handle



<b>KRT903101</b>	Weight 250g	 5 400338 064012 >
<b>KRT903102</b>	Weight 450g	 5 400338 064029 >

- Hardened tempered head
- Fibreglass shank
- Ergonomic soft grip TPR handle



<b>KRT903103</b>	Weight 450g	 5 400338 064036 >
------------------	----------------	-----------------------

### ONE PIECE METAL

- Hammer head and shank out of one piece
- Pre-shaped ergonomic soft grip TPR handle
- Best balance



<b>KRT903104</b>	Weight 550g	 5 400338 064043 >
------------------	----------------	-----------------------

### GRAPHITE

- Hardened tempered head
- Graphite shank
- Ergonomic soft grip TPR handle
- Maximum solidity



<b>KRT903201</b>	Weight 550g	 5 400338 064050 >
------------------	----------------	-----------------------

## ROOFING HAMMER

For those who are not afraid of heights, this specific hammer type is developed to work on scaffolds.

- Tempered hammer head
- Tubular metal shank
- Pre-shaped ergonomic soft grip TPR handle
- Magnetic nail holder
- Claw to pierce slate



<b>KRT905001</b>	Weight 600g	 5 400338 064166 >
------------------	----------------	-----------------------

## MASON'S HAMMER

2-in-1, this hammer comes with flat face and chisel-shaped blade for both cutting and shaping brick and stone.

- Tempered hammer head
- Tubular metal shank
- Pre-shaped ergonomic soft grip TPR handle
- Strong chisel to cut slate and bricks



<b>KRT905002</b>	Weight 600g	 5 400338 064173 >
------------------	----------------	-----------------------

## AXE HAMMER

No need to carry two different tools, this hammer functions as hammer and axe.

- Tempered hammer head
- Tubular metal shank
- Pre-shaped ergonomic soft grip TPR handle
- Axe for cutting wooden materials



<b>KRT905003</b>	Weight 600g	 5 400338 064180 >
------------------	----------------	---

## DEAD BLOW Mallet

No kick-back, the loose material inside the head of this mallet will absorb the rebound of the strike and increase the driving force. Insulated and sparkless. Dead blow mallets take care of your comfort and safety.

- Urethane hammer in one piece
- Insulated & sparkless
- No kick-back



**NO KICK-BACK**



<b>KRT905004</b>	Weight 700g	 5 400338 064197 >
------------------	----------------	---

## BEECHWOOD Mallet

Useful for chiselling or to strike wooden poles on windy beaches. It will not deform the striking end of a metal tool and it will reduce the force required to drive the cutting edge of the chisel.

- Head with bevelled corners
- Beechwood handle and head
- Conical handle
- Ideal to work with wood chisels



<b>KRT905005</b>	Head size 114 x 90 x 56mm	 5 400338 064500 >
------------------	---------------------------------	---

## RUBBER MALLETS

Ideal for woodworking tasks or forming sheet metal, as they don't leave marks. You can opt for a white or black rubber head mallet, with wooden or fibreglass shaft.

- Eucalypt wood handle
- Black rubber head



<b>KRT904001</b>	Weight 450g	 5 400338 064067 >
<b>KRT904002</b>	Weight 700g	 5 400338 064074 >
<b>KRT904003</b>	Weight 900g	 5 400338 064081 >

- Eucalypt wood handle
- White rubber head



<b>KRT904004</b>	Weight 450g	 5 400338 064098 >
<b>KRT904005</b>	Weight 700g	 5 400338 064104 >
<b>KRT904006</b>	Weight 900g	 5 400338 064111 >

- Rubber & synthetic head
- Wooden handle



<b>KRT904007</b>	Head size Ø 40mm	 5 400338 064159 >
------------------	---------------------	---

- Black rubber head
- Fibreglass shank
- Ergonomic soft grip TPR handle



<b>KRT904101</b>	Weight 450g	 5 400338 064128 >
<b>KRT904102</b>	Weight 700g	 5 400338 064135 >
<b>KRT904103</b>	Weight 900g	 5 400338 064142 >

# Tool sets

## COMBINATION TOOL SETS

Kreator tool sets include all the tools needed to complete basic DIY projects around the home. The tools are packed in modern cases for easy tool storage and portability.

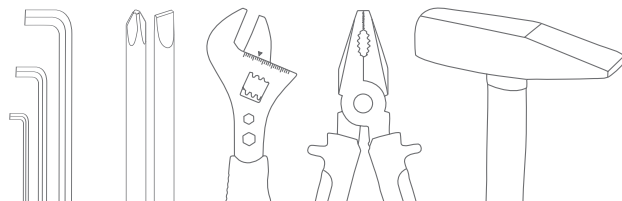
**20  
PCS**
**CR-V**

- 8x hex key wrench:
  - 1.5, 2, 2.5, 3, 4, 5, 5.5, 6mm
- 2x precision screwdriver:
  - SL2
  - ⊕ PH#0
- 4x screwdriver:
  - SL5 75mm
  - SL6 100mm
  - ⊕ PH1 75mm
  - ⊕ PH2 100mm
- Measuring tape 5m
- Scissors 145mm
- Snap-off cutter 18mm
- Combination pliers 150mm
- Adjustable wrench 200mm
- Machinist hammer fibreglass 300g

**KRT951003**

 Qty  
20 pcs

5 400338 065491 &gt;

**26  
PCS**
**CR-V**

- 8x hex key wrench:
  - 1.5, 2, 2.5, 3, 4, 5, 5.5, 6mm
- 10x combination wrench:
  - 8, 9, 10, 11, 12, 13, 14, 15, 17, 19mm
- 2x stubby screwdriver:
  - SL6 x 38mm
  - ⊕ PH2 x 38mm
- 6x screwdriver:
  - SL4 100mm
  - SL6 150mm
  - SL8 200mm
  - ⊕ PH1 100mm
  - PH2 150mm
  - PH3 200mm

**KRT951000**

 Qty  
26 pcs

5 400338 061660 &gt;

**48  
PCS**
**CR-V**

- 24x bit:
  - SL3, SL4, SL5.5, SL7
  - ⊕ PH0, PH1, PH2, PH3
  - ⊕ PZ0, PZ1, PZ2, PZ3
  - ⊕ T10, T15, T20, T25, T27, T30, T40
  - H2, H3, H4, H5, H6
- 11x hex key wrench:
  - 1.27, 1.5, 2, 2.5, 3, 3.5, 4, 4.5, 5, 5.5, 6mm
- 3x precision screwdriver:
  - SL1.5
  - ⊕ PH#00, PH#0
- 2x screwdriver:
  - SL6 100mm
  - ⊕ PH2 100mm
- Head lamp
- Measuring tape 3m
- Snap-off cutter 18mm
- Bit holder screwdriver
- Combination pliers 175mm
- Long nose pliers 150mm
- Adjustable wrench 200mm
- Machinist hammer fibreglass 300g

**KRT951004**

 Qty  
48 pcs

5 400338 065507 &gt;

52  
PCS

CR-V



1/4" DRIVE

- 9x socket 1/4":  
5, 6, 7, 8, 9, 10, 11, 12, 13mm
- 72T ratchet handle 1/4"
- 11x hex key wrench:  
⊕ 1.27, 1.5, 2, 2.5, 3, 3.5, 4, 4.5, 5, 5.5, 6mm
- 11x bit:  
⊖ SL3, SL4, SL5  
⊕ PH1, PH2  
⊗ T15, T20, T25, T30
- 2x stubby screwdriver:  
⊖ SL6 x 38mm  
⊕ PH2 x 38mm
- 4x screwdriver:  
⊖ SL5 75mm  
SL6 100mm  
⊕ PH1 75mm  
PH2 100mm
- 6x combination spanner:  
10, 11, 12, 13, 14, 15mm
- 72T ratchet handle 1/4"
- Measuring tape 2m
- Combination plier 160mm
- Long nose plier 160mm
- Adjustable wrench 200mm
- Water pump plier 250mm
- Machinist hammer wood 300g
- **C** Magnetic bit holder screwdriver

KRT951001

Qty  
52 pcs



5 400338 061677 >

109  
PCS

CR-V



1/2" DRIVE

- 15x socket 1/2":  
8, 9, 10, 11, 12, 13, 14, 15, 16, 17, 18, 19, 20, 21, 22mm
- Spark plug socket 1/2" 21mm
- Extension bar 70 & 120mm
- 72T ratchet handle 1/2"
- 42x bit:  
⊖ SL3, SL4 x2, SL5 x2, SL6 x2, SL7 x2  
⊕ PH0 x2, PH1 x2, PH2 x2, PH3 x2  
⊕ PZ0 x2, PZ1 x2, PZ2 x2, PZ3 x2  
⊗ T10, T15, T20, T25, T27, T30  
○ H2, H2.5, H3, H4, H5, H5.5, H6  
○ S0, S1, S2, S3
- 9x hex key wrench:  
○ 1.5, 2, 2.5, 3, 4, 5, 6, 8, 10mm
- 2x precision screwdriver:  
⊖ SL3 70mm  
⊕ PH0 70mm
- 2x stubby screwdriver:  
⊖ SL6 38mm  
⊕ PH2 38mm
- 5x screwdriver:  
⊖ SL5 75mm  
SL6 100mm  
⊕ PH1 75mm  
PH2 100mm  
PH3 150mm
- 8x double open spanner:  
6 x 7, 8 x 9, 10 x 11, 12 x 13, 14 x 15, 16 x 17, 18 x 19, 20x22mm
- Spark plug socket 1/2" 21mm
- 2x extension bar:  
70mm & 120mm
- Measuring tape 5m
- Zinc alloy knife
- Snap-off cutter 18mm
- 3x snap-off blade in plastic tube 18mm
- Magnetic bit holder screwdriver
- Mini handsaw 150mm
- 4x saw blade 150mm
- Voltage tester AC 100-250V~
- Adjustable wrench 150mm
- Diagonal plier 160mm
- Combination plier 200mm
- Long nose plier 200mm
- Crimping plier
- 72T ratchet handle 1/2"
- Half round file 200mm
- Water pump plier 250mm
- Machinist hammer wood 300g
- **C** Magnetic bit holder screwdriver

KRT951002

Qty  
109 pcs



5 400338 061684 >



**158  
PCS**

**2x  
DRAWER**



- 8x hex key:
  - ⊖ 1.5, 2, 2.5, 3, 4, 5, 5.5, 6mm
- 7x hex key:
  - ⊕ T10, T15, T20, T25, T27, T30, T40
- 35x screw and plugs:
  - 12x plug E5
  - 6x plug E6
  - 12x screw 3.5\*25mm
  - 5x screw 4\*30mm
- 9x HSS metal drill:
  - 1, 2, 2.5, 3, 3.5, 4, 4.5, 5, 5.5mm
- Bit holder
- 50x screwdriver, bit 25mm, CR-V sandblasted:
  - ⊖ 3mm x2, 4mm x2, 5mm x2, 6mm x2, 7mm x2
  - ⊕ PH0 x2, PH1 x3, PH2 x3, H3 x2
  - ⊕ PZ0 x2, PZ1 x3, PZ2 x3, PZ3 x2
  - H2 x2, H3 x2, H4 x2, H5 x2, H6 x2
- ⊕ T10, T15 x2, T20 x2, T25 x2, T27, T30 x2
- 6x precision screwdriver:
  - SL1.4, SL 2, SL 2.4, SL 3
  - ⊕ PH00, PH0
- Ratchet handle 1/4"
- 14x DR socket 1/4":
  - 4, 4.5, 5, 5.5, 6, 6.5, 7, 8, 9, 10, 11, 12, 13, 14mm
- 1/4" DR extension bar 50mm
- Ratchet handle 3/8"
- 14x DR socket 3/8":
  - 6, 7, 8, 9, 10, 11, 12, 13, 14, 15, 16, 17, 18, 19mm
- 3/8" DR extension bar 75mm
- Long nose pliers 150mm
- Diagonal pliers 150mm
- 7x combination wrench:
  - 8, 9, 10, 11, 12, 13, 14mm
- Machinist hammer 200g dual material handle

<b>KRT951010</b>	Qty 158 pcs	 5 400338 071751 >
------------------	----------------	--

**253  
PCS**



- 6x precision screwdriver:
  - ⊖ SL1, SL1.4, SL1.8, SL2.4
  - ⊕ PH0, PH1
- 9x hex key:
  - 1.5, 2, 2.5, 3, 4, 5, 6, 8, 10mm
- 24x screw bit:
  - ⊖ SL3, SL4, SL5, SL6, SL7
  - ⊕ PH0, PH1, PH2, PH3, PH4
  - ⊕ PZ1, PZ2
  - H3, H4, H5, H6, H7, H8
  - T10, T15, T20, T25, T30, T35
- Bit handle carbon steel
- Voltage tester AC 100-250V~
- Magnetic bit holder
- 11x screwdriver:
  - ⊖ SL6 38mm, SL3 75mm, SL4 100mm, SL5 75mm, SL6 100mm
  - ⊕ PH0 75mm, PH1 100mm, PH1 75mm, PH2 100mm, PH2 38mm, PH3 150mm
- 3x isolated screwdriver:
  - ⊖ SL4 x 100mm, SL5.5 x 125mm
  - ⊕ PH1 x 100mm
- 6" diagonal pliers
- 8" adjustable wrench
- 9" water pump pliers
- 6" long nose pliers
- 6" combination pliers
- 9x combination wrench:
  - 8, 10, 11, 12, 13, 14, 15, 17, 19mm
- 14x 1/2" DR socket:
  - 8, 9, 10, 11, 12, 13, 14, 15, 16, 17, 18, 19, 20, 30mm
- 1/2" DR ratchet handle
- 2x 1/2" DR 16 & 21mm plug sockets
- 1/2" DR universal joint
- 1/2" DR sliding T-bar
- 1/2" DR 5" extension bar
- 15x 1/4" DR socket:
  - 4, 4.5, 5, 5.5, 6, 6.5, 7, 7.5, 8, 9, 10, 11, 12, 13, 14mm
- 1/4" DR universal joint
- 1/4" DR 2" extension bar
- 1/4" DR sliding T-bar
- 1/4" DR 4" extension bar
- 1/4" DR ratchet handle
- Flexible extension 6"
- Spinner handle
- 2x nylon clamp 3.5"
- Wire stripper
- 130x fastener: 6x picture hook, 5x plug, 5x push tack, 15x nail brass coated, 48x 30mm nail, 41x 15mm nail
- Claw hammer carbon steel 340g
- Measuring tape 5m
- 10" level
- Electric tape 9m
- Utility knife
- Tyre gauge
- 7" locking pliers
- Mini hand saw 150mm

<b>KRT951011</b>	Qty 253 pcs	 5 400338 071768 >
------------------	----------------	--

47  
PCS



- 20x bit:
  - ⊖ SL4, SL5, SL6
  - ⊕ PH1, PH2 x2, PH3
  - ⊕ PZ1, PZ2, PZ3
  - T10, T15, T20, T25, T27, T30
  - H3, H4, H5, H6
- 11x hex key:
  - 1.27, 1.5, 2, 2.5, 3, 3.5, 4, 4.5, 5, 5.5, 6mm
- 6x precision screwdriver:
  - ⊖ SL1.4, SL2, SL2.5, SL3
  - ⊕ PH#00, PH#0
- Measuring tape 5m
- Combination plier 175mm
- Diagonal plier 150mm
- Snap-off cutter + 3x spare blade 18mm
- Hacksaw + saw blade 250mm
- Torpedo level 225mm
- Water pump plier 250mm
- Claw hammer fibreglass 450g
- Tool tote bag
-  Magnetic bit holder screwdriver

KRT951007

Qty  
47 pcs



5 400338 065545 >

61  
PCS



**3/8" DRIVE**

- 12x socket 3/8":
  - 8, 9, 10, 11, 12, 13, 14, 15, 16, 17, 19, 22mm
- Spark plug socket 21mm
- Extension bar 3/8" 21mm
- 24T ratchet handle 3/8"
- 30x bit:
  - ⊖ SL2, SL3, SL4, SL5, SL6, SL7
  - ⊕ PH0, PH1, PH2, PH3
  - ⊕ PZ0, PZ1, PZ2, PZ3
  - T10, T15, T20, T25, T30, T40
  - H2, H3, H4, H5, H6, H7
  - S0, S1, S2, S3
- 2x screwdriver :
  - ⊖ SL6
  - ⊕ PH2
- Long nose plier 150mm
- Water pump plier 250mm
- Diagonal cutting plier 150mm
- 9x hex key wrench:
  - 1.5, 2, 2.5, 3, 4, 5, 6, 8, 10mm
- Driver handle
- Universal joint

KRT951008

Qty  
61 pcs



5 400338 067396 >

89  
PCS



**1/2" DRIVE**

- 9x socket 1/2":
  - 14, 15, 16, 17, 19, 21, 22, 24, 27mm
- Spark plug socket 21mm
- Extension bar 120mm
- 24T ratchet handle 1/2"
- 1/4" DRIVE
  - 13x socket 1/4":
    - 4, 4.5, 5, 5.5, 6, 6.5, 7, 8, 9, 10, 11, 12, 13mm
  - Extension bar 70mm
  - 24T ratchet handle 1/4"
  - 20x bit:
    - ⊖ SL2, SL3, SL4, SL5, SL6, SL7
    - ⊕ PH0, PH1, PH2, PH3
    - ⊕ PZ0, PZ1, PZ2, PZ3
    - T10, T15, T20, T25, T30, T40
- 5x screwdriver:
  - ⊖ SL5, SL6
  - ⊕ PH1, PH2
- 2x stubby screwdriver:
  - ⊖ SL6
  - ⊕ PH2
- 8x combination spanner:
  - 8, 10, 12, 13, 14, 15, 17, 19mm
- 9x hex key:
  - 1.5, 2, 2.5, 3, 4, 5, 6, 8, 10mm
- Long nose plier 150mm
- Diagonal cutting plier 150mm
- Combination plier 150mm
- Screwdriver Bit holder
- Snap-off cutter 18mm
- 10x spare blade 18mm
- Machinist hammer 300g
- Mini handsaw
- Measuring tape 5m

KRT951009

Qty  
89 pcs



5 400338 067402 >

# Pliers

## STANDARD QUALITY



**Carbon steel**  
Polished finished

## PROFESSIONAL QUALITY



**Chrome vanadium**  
Satin finished

## VDE



**Chrome nickel steel**  
Polished finished

## PLIERS

When cutting, bending, compressing or holding materials firmly, Kreator can offer you a wide range of pliers. They are made for various general and specific purposes.

- Carbon steel
- Fully hardened
- Polished finish
- PVC handle



<b>KRT601001</b>	Size 150mm 6"	
<b>KRT601002</b>	Size 200mm 8"	

### FLAT



<b>KRT605001</b>	Size 150mm 6"	
------------------	---------------------	--

### ROUND



<b>KRT605002</b>	Size 150mm 6"	
------------------	---------------------	--

- Chrome vanadium
- Fully hardened

- Satin finish
- Soft grip TPR handle



<b>KRT605103</b>	Size 175mm 7"	internal	
------------------	---------------------	----------	--



<b>KRT605104</b>	Size 175mm 7"	external	
------------------	---------------------	----------	--



### LONG NOSE PLIERS

- Chrome vanadium
- Fully hardened
- Satin finish
- Soft grip TPR handle



<b>KRT601101</b>	Size 150mm 6"	
<b>KRT601102</b>	Size 200mm 8"	

### FLAT



<b>KRT605101</b>	Size 150mm 6"	
------------------	---------------------	--

### ROUND



<b>KRT605102</b>	Size 150mm 6"	
------------------	---------------------	--

### CIRCLIP PLIERS

- Internal and external
- 4-in-1
- Fully hardened
- Black finish
- Grip handle



<b>KRT605105</b>	Size 150mm 6"	internal external	
------------------	---------------------	----------------------	--



**BENT NOSE PLIERS**

- Carbon steel
- Fully hardened
- Polished finish
- PVC handle



<b>KRT604001</b>	Size 150mm 6"	5 400338 060717 >
<b>KRT604002</b>	Size 200mm 8"	5 400338 060724 >

- Chrome vanadium
- Fully hardened
- Satin finish
- Soft grip  
TPR handle



<b>KRT604101</b>	Size 150mm 6"	5 400338 060731 >
<b>KRT604102</b>	Size 200mm 8"	5 400338 060748 >

- Carbon steel
- Fully hardened
- Polished finish
- PVC handle

**COMBINATION PLIERS**



<b>KRT602001</b>	Size 150mm 6"	5 400338 060373 >
<b>KRT602002</b>	Size 175mm 7"	5 400338 060380 >
<b>KRT602003</b>	Size 200mm 8"	5 400338 060397 >

- Chrome vanadium
- Fully hardened
- Satin finish
- Soft grip  
TPR handle



<b>KRT602101</b>	Size 150mm 6"	5 400338 060403 >
<b>KRT602102</b>	Size 175mm 7"	5 400338 060410 >
<b>KRT602103</b>	Size 200mm 8"	5 400338 060427 >



**DIAGONAL PLIERS**

- Carbon steel
- Fully hardened
- Polished finish
- PVC handle



<b>KRT603001</b>	Size 125mm 5"	5 400338 060434 >
<b>KRT603002</b>	Size 150mm 6"	5 400338 060458 >
<b>KRT603003</b>	Size 175mm 7"	5 400338 060465 >

- Chrome vanadium
- Fully hardened
- Satin finish
- Soft grip  
TPR handle



<b>KRT603101</b>	Size 125mm 5"	5 400338 060489 >
<b>KRT603102</b>	Size 150mm 6"	5 400338 060496 >
<b>KRT603103</b>	Size 175mm 7"	5 400338 060502 >

- Carbon steel
- Fully hardened
- Polished finish
- PVC handle

**BIG HEAD  
DIAGONAL PLIERS**



<b>KRT603004</b>	Size 175mm 7"	5 400338 060472 >
------------------	---------------------	-------------------

- Chrome vanadium
- Fully hardened
- Satin finish
- Soft grip  
TPR handle



<b>KRT603104</b>	Size 175mm 7"	5 400338 060519 >
<b>KRT603105</b>	Size 200mm 8"	5 400338 060526 >



**VDE PLIERS**

- Chrome nickel steel
- Fully hardened
- Polished finish
- Soft grip TPR handle

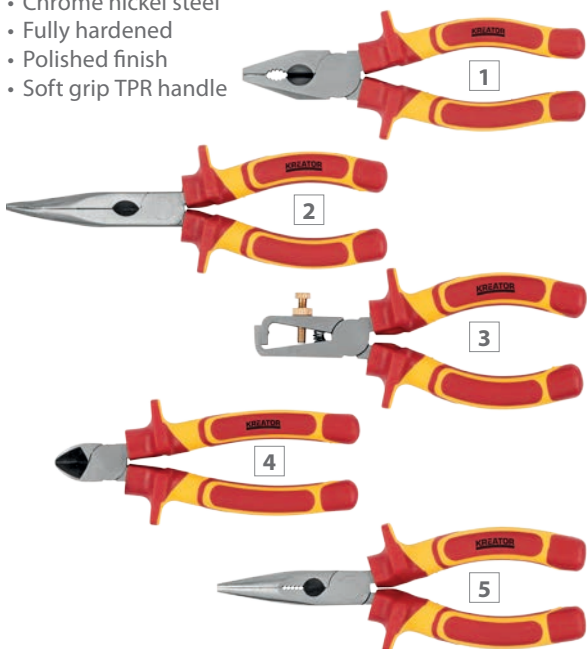

<b>KRT620001</b> (1)	Size 150mm 6"	5 400338 060571 >
<b>KRT620002</b> (2)	Size 200mm 8"	5 400338 060588 >
<b>KRT620003</b> (3)	Size 150mm 6"	5 400338 060595 >
<b>KRT620004</b> (4)	Size 150mm 6"	5 400338 060601 >
<b>KRT620005</b> (5)	Size 150mm 6"	5 400338 060618 >



**MINI PLIERS**

- Carbon steel
- Fully hardened
- Nickel plated
- PVC handle



<b>KRT613001</b> (1)	Size 125mm 5"	5 400338 059711 >
<b>KRT613002</b> (2)	Size 125mm 5"	5 400338 059728 >
<b>KRT613003</b> (3)	Size 120mm 5"	5 400338 059735 >
<b>KRT613004</b> (4)	Size 100mm 5"	5 400338 059742 >
<b>KRT613005</b> (5)	Size 125mm 5"	5 400338 059759 >

**5**  
PCS/  
SET

- Carbon steel
- Fully hardened
- Nickel plated
- PVC handle



<b>KRT613006</b>	Size 125mm 5"	5 400338 059766 >
------------------	---------------------	-------------------



## WIRE STRIP PLIERS

Designed to strip the electrical insulation from electric wires. Kreator offers various types of wire strip pliers according to different needs.

- Carbon steel
- Fully hardened
- Polished finish
- PVC handle



**KRT606001**

Size  
150mm  
6"



- Chrome vanadium
- Fully hardened
- Satin finish
- Soft grip TPR handle



**KRT606101**

Size  
150mm  
6"



**Professional quality**

- Cable sizes: 0.6, 0.8, 1.0, 1.3, 1.6, 2.0, 2.6mm
- Cutting function
- Safety lock
- Comfort grip handle
- Copper and aluminum (not for cutting steel wire)



**KRT606002**



**Professional quality**

- Automatic wire stripper & crimper
- Cable sizes: 0.2 to 6mm
- Fully hardened
- Soft grip pp & TPR handle



**KRT606006**



- Automatic wire stripper
- Pressure adjustment button
- Length stop
- Wire cutter



Length stop

**LENGTH STOP**

**KRT606004**



## REVOLVING LEATHER PUNCH PLIERS

Kreator's revolving leather punch pliers are convenient spring-tension, self-opening pliers for punching round holes in leather, plastic, rubber, canvas and cardboard.

- Standard quality
- 6 sizes: Ø 2, 2.5, 3, 3.5, 4, 4.5mm



**KRT614001**



**Professional quality**

- 6 sizes: Ø 2.5, 3, 3.5, 4, 4.5, 5mm
- Soft grip dipped handle



**KRT614101**



## CRIMPING TOOLS

The success of your electrical repair depends on three factors: adequate power, correct wire size to carry that power and proper connection of the wire to the terminal. Without a good connection between the wire and terminal, all your work will be wasted.

- Professional quality
- Crimping tool
- Ergonomic handle
- Wire cutter
- Insulated closure
- Bolt cutter
- Non-insulated closure
- Wire stripper



KRT615101

Size  
230mm  
9"



- Crimping connector set: 160pcs



106  
PCS



KRT615103

Qty  
160 pcs



- Professional quality
- Crimping tool
- Comfort grip handle
- Wire cutter
- Insulated closure
- Non-insulated closure
- Wire stripper



KRT615111

Size  
200mm  
8"



- Professional quality
- High precision crimping tool
- Ergonomic handle
- Pressure adjusting button
- Suitable for various terminals



KRT615112

Size  
230mm  
9"



- Modular telephone plug crimper 6P/8P
- + 24pc terminal 6P/8P
- Comfortable grip handle
- Cable cutter and stripper
- Built-in-safety ratchet release



KRT615121

Size  
185mm  
7"



## GROMMET PLIERS

Kreator grommet pliers are perfect to install grommets in fabric that need strong tying or connecting points, like tent canvases, shower curtains and tarps.

- Grommet plier
- Soft grip dipped handle



KRT616101

Size  
Ø 4mm



KRT616104

Size  
Ø 7mm



100  
PCS

- Eyelets: 100 pcs

KRT616102

Size Ø 4mm  
brass plated



KRT616103

Size Ø 4mm  
aluminium



KRT616105

Size Ø 7mm  
brass plated



KRT616106

Size Ø 7mm  
aluminium



- Grommet tool
- + 10 pcs aluminium grommets

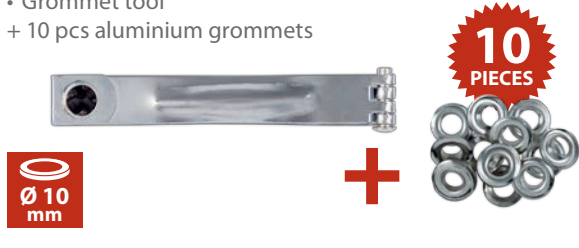

Ø 10 mm

**10**  
PIECES

<b>KRT616107</b>	Size Ø 10mm	5 400338 060120 >
------------------	----------------	-------------------

- Grommets: 25 pcs

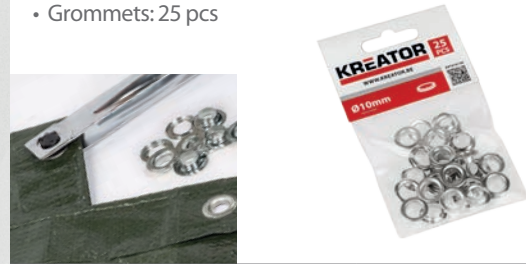

**25**  
PCS

<b>KRT616108</b>	Size Ø 10mm aluminium	5 400338 060137 >
------------------	--------------------------	-------------------

- Grommet tool
- + 30 pcs aluminium grommets

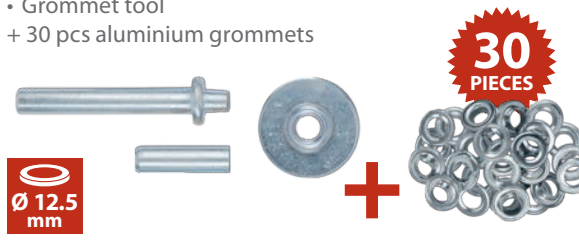

Ø 12.5 mm

**30**  
PIECES

<b>KRT616109</b>	Size Ø 12.5mm	5 400338 060144 >
------------------	------------------	-------------------

- Grommets: 25 pcs

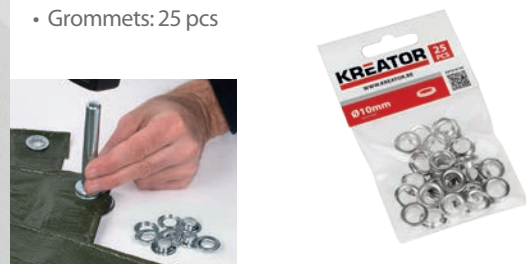

**25**  
PCS

<b>KRT616110</b>	Size Ø 12.5mm aluminium	5 400338 060151 >
------------------	----------------------------	-------------------

## RIVETING PLIERS

When joining aluminium or plastic, Kreator's riveting pliers make sure that rivets are permanently fixed in position, holding the two pieces together.

- Professional quality
- Rivet plier + 120 pcs rivets:
  - 30 pcs: Ø 2.4mm
  - 30 pcs: Ø 3.2mm
  - 30 pcs: Ø 4.0mm
  - 30 pcs: Ø 4.8mm



**120**  
PIECES



<b>KRT617103</b>	Size 275mm 11"	5 400338 060021 >
------------------	----------------------	-------------------

- Standard quality
- Rivet plier + 60pcs rivets:
  - 15 pcs: Ø 2.4mm
  - 15 pcs: Ø 3.2mm
  - 15 pcs: Ø 4.0mm
  - 15 pcs: Ø 4.8mm

**60**  
PIECES



<b>KRT617101</b>	Size 230mm 9"	5 400338 060014 >
------------------	---------------------	-------------------

- Professional quality
- 4-in-1:
  - Ø 2.4mm
  - Ø 3.2mm
  - Ø 4.0mm
  - Ø 4.8mm
- Ergonomic handle



**4-in-1**

<b>KRT617102</b>	Size 275mm 11"	5 400338 059506 >
------------------	----------------------	-------------------





## WATER PUMP PLIERS

When turning and holding nuts and bolts or clamping materials, our water pump pliers are there to help you.

- Carbon steel
- Fully hardened
- Polished finish
- PVC handle

**250 mm**  
**10"**

**300 mm**  
**12"**



<b>KRT607001</b>	Size 250mm 10"	5 400338 060809 >
<b>KRT607002</b>	Size 300mm 12"	5 400338 060816 >



- Chrome vanadium
- Fully hardened
- Satin finish
- Soft grip TPR handle

**BOX JOINT**

**250 mm**  
**10"**

**300 mm**  
**12"**



<b>KRT607101</b>	Size 250mm 10"	5 400338 060823 >
<b>KRT607102</b>	Size 300mm 12"	5 400338 060830 >

## LOCKING PLIERS

Kreator offers locking pliers in different sizes, quality and configurations.

- Carbon steel
- Fully hardened
- Nickel plated

**185 mm**  
**7.5"**

**230 mm**  
**9"**



<b>KRT608001</b>	Size 185mm 7.5"	5 400338 059537 >
<b>KRT608002</b>	Size 230mm 9"	5 400338 059544 >



- Chrome molybdenum
- Fully hardened
- Nickel plated
- Soft grip TPR handle

**BOX JOINT**

**185 mm**  
**7.5"**

**230 mm**  
**9"**



<b>KRT608101</b>	Size 185mm 7.5"	5 400338 060656 >
<b>KRT608102</b>	Size 230mm 9"	5 400338 060663 >

- Carbon steel
- Fully hardened
- Nickel plated

**175 mm**  
**7"**

**215 mm**  
**8.5"**



<b>KRT608003</b>	Size 175mm 7"	5 400338 059551 >
<b>KRT608004</b>	Size 215mm 8.5"	5 400338 059568 >

- Chrome molybdenum
- Fully hardened
- Nickel plated
- Soft grip TPR handle

**175 mm**  
**7"**

**215 mm**  
**8.5"**



<b>KRT608103</b>	Size 175mm 7"	5 400338 060670 >
<b>KRT608104</b>	Size 215mm 8.5"	5 400338 060687 >

## CARPENTER PINCERS

When removing objects like nails, clips and suchlike out of different materials, Kreator's carpenter pincers are essential.

- Carbon steel
- Fully hardened
- Black sprayed finish
- Soft grip dipped handle

175 mm 7"  
200 mm 8"  
250 mm 10"



<b>KRT609001</b>	Size 175mm 7"	5 400338 059575 >
<b>KRT609002</b>	Size 200mm 8"	5 400338 059582 >
<b>KRT609003</b>	Size 250mm 10"	5 400338 059599 >



- Chrome vanadium
- Fully hardened
- Satin finish
- Soft grip 2 colour dipped handle

175 mm 7"  
200 mm 8"  
250 mm 10"



<b>KRT609101</b>	Size 175mm 7"	5 400338 059605 >
<b>KRT609102</b>	Size 200mm 8"	5 400338 059612 >
<b>KRT609103</b>	Size 250mm 10"	5 400338 059629 >

## TOWER PINCERS

As our carpenter pincers, these tower pincers are ideal to pinch, cut or pull any object. Available in different sizes and finishing.

- Carbon steel
- Fully hardened
- Black sprayed finish
- Soft grip dipped handle

230 mm 9"  
250 mm 10"



<b>KRT610001</b>	Size 230mm 9"	5 400338 059636 >
<b>KRT610002</b>	Size 250mm 10"	5 400338 059643 >



- Chrome vanadium
- Fully hardened
- Satin finish
- Soft grip 2 colour dipped handle

230 mm 9"  
250 mm 10"



<b>KRT610101</b>	Size 230mm 9"	5 400338 059650 >
<b>KRT610102</b>	Size 250mm 10"	5 400338 059667 >

## Notes

---



---



---



---



---

## HEAVY DUTY SCISSORS

To cut thick or hard materials, professional heavy duty scissors with stainless steel blades are just great.



- Professional quality
- Stainless steel
- Blade hardness: HRC53
- Soft grip TPR handle

- Max. cutting capacity: Ø 5mm
- Long nose



<b>KRT621001</b>	Size 200mm 8"	 5 400338 059414 >
------------------	---------------------	--

- Max. cutting capacity: Ø 10mm



<b>KRT621002</b>	Size 175mm 7"	 5 400338 059421 >
------------------	---------------------	--

## TIN SNIPS

Developed to cut sheet metal and other tough webs. There are three cutting styles: straight cutting, left cutting and right cutting.

- Chrome vanadium
- Fully hardened
- Polished finish
- Soft grip TPR handle



**STRAIGHT**



<b>KRT611101</b>	Size 250mm 10"	 5 400338 060625 >
------------------	----------------------	--



**LEFT**



<b>KRT611102</b>	Size 250mm 10"	 5 400338 060632 >
------------------	----------------------	--



**RIGHT**



<b>KRT611103</b>	Size 250mm 10"	 5 400338 060649 >
------------------	----------------------	--

## BOLT CUTTERS

Ideal to cut chains, padlocks, bolts,... Their long handles and short blades maximize leverage and cutting force.

- High carbon steel
- Fully hardened
- Polished finish



- Max. cutting capacity: Ø 3mm



<b>KRT612001</b>	Size 300mm 12"	 5 400338 059674 >
------------------	----------------------	--

- Max. cutting capacity: Ø 5mm



<b>KRT612002</b>	Size 350mm 14"	 5 400338 059681 >
------------------	----------------------	--

- Max. cutting capacity: Ø 6mm



<b>KRT612003</b>	Size 450mm 18"	 5 400338 059698 >
------------------	----------------------	--

- Max. cutting capacity: Ø 8mm

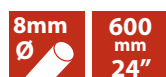

<b>KRT612004</b>	Size 600mm 24"	 5 400338 059704 >
------------------	----------------------	--

# Chisels & wrecking bars

## WOOD CHISELS

Meet the Kreator wood chisels, essential for every carpenter. These chisels range from small hand tools for tiny details, to large chisels for removing big sections of wood.



- 65Mn steel
- Soft grip TPR handle



<b>KRT461101</b>	Head size 6mm	
<b>KRT461102</b>	Head size 8mm	
<b>KRT461103</b>	Head size 10mm	
<b>KRT461104</b>	Head size 12mm	
<b>KRT461105</b>	Head size 16mm	
<b>KRT461106</b>	Head size 19mm	
<b>KRT461107</b>	Head size 25mm	
<b>KRT461108</b>	Head size 32mm	

- 65Mn steel
- Soft grip TPR handle
- Length 250mm

**4  
PIECES**



<b>KRT461109</b>	Head size 6mm 12mm 19mm 25mm	
------------------	--	--

- Carbon steel
- Wooden handle
- Length 250mm

**4  
PIECES**



<b>KRT461003</b>	Head size 6mm 12mm 18mm 24mm	
------------------	--	--

- Mini wood chisel set
- Wooden handle
- Length 135mm



<b>KRT461001</b>	Qty 6	
<b>KRT461002</b>	Qty 12	

## COLD CHISELS

These tempered steel chisels are commonly used to cut stone or bricks. Ideal for your demolition projects.

- Carbon steel
- Hex shank 16mm
- Pointed head

**HEX  
16**



<b>KRT462001</b>	Size 250mm	
<b>KRT462002</b>	Size 300mm	
<b>KRT462003</b>	Size 350mm	

- Carbon steel
- Flat head 30mm
- Flat shank



<b>KRT462004</b>	Size 250mm	5 400338 061905 >
<b>KRT462005</b>	Size 300mm	5 400338 061912 >
<b>KRT462006</b>	Size 350mm	5 400338 061929 >

- Carbon steel
- Hex shank 16mm
- Soft grip TPR handle
- Pointed head



**HEX  
16**

<b>KRT462104</b>	Size 200mm	5 400338 061776 >
<b>KRT462105</b>	Size 300mm	5 400338 061783 >

- Carbon steel
- Hex shank 16mm
- Soft grip TPR handle
- Flat head 21mm



**HEX  
16**

<b>KRT462106</b>	Size 200mm	5 400338 061790 >
<b>KRT462107</b>	Size 300mm	5 400338 061806 >

- Carbon steel
- Joint chisel
- Soft grip TPR handle



<b>KRT462101</b>	Size 60mm	5 400338 061745 >
<b>KRT462102</b>	Size 80mm	5 400338 061752 >
<b>KRT462103</b>	Size 100mm	5 400338 061769 >

- Chrome vanadium
- Hex shank 8mm - Length 140mm
- Hex shank 10mm - Length 150mm
- Hex shank 13mm - Length 160mm

**3  
PIECES**



<b>KRT462007</b>	Head size 10mm 12mm 16mm	5 400338 062377 >
------------------	-----------------------------------	-------------------

## NAIL & CENTER PUNCHES

Discover our punches, used to drive nails or to form a centering mark on a workpiece. Available in standard or professional design with TPR handle.



- Chrome vanadium
- Nail punch



<b>KRT463001</b>	Head size 0.8mm		5 400338 062261 >
<b>KRT463002</b>	Head size 1.6mm		5 400338 062278 >
<b>KRT463003</b>	Head size 2.4mm		5 400338 062285 >
<b>KRT463005</b>	Head size 3.2mm		5 400338 062308 >



- Chrome vanadium
- Nail punch

**3  
PIECES**



<b>KRT463004</b>	Head size 0.8mm 1.6mm 2.4mm		5 400338 062292 >
------------------	--------------------------------------	--	-------------------



- Chrome vanadium
- Nail punch
- Soft grip TPR handle



<b>KRT463006</b>	Head size 0.8mm		5 400338 062315 >
<b>KRT463007</b>	Head size 1.6mm		5 400338 062322 >
<b>KRT463008</b>	Head size 2.4mm		5 400338 062339 >

## NAIL PULLERS

Pull out every nail with the versatile and easy-to-use Kreator nail pullers. They allow to remove a nail in 3 different ways.

- Carbon steel
- Nail puller

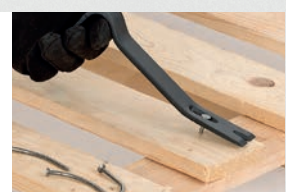

<b>KRT464001</b>	Size 175mm	5 400338 061851 >
<b>KRT464002</b>	Size 375mm	5 400338 061868 >



- Chrome vanadium
- Nail punch
- Soft grip TPR handle

**3**  
PIECES



<b>KRT463009</b>	Head size 0.8mm 1.6mm 2.4mm		5 400338 062346 >
------------------	--------------------------------------	--	-------------------

- Chrome vanadium
- Hex shank 8mm
- Length 150mm



**3**  
PIECES



<b>KRT463010</b>	Head size 3mm 4mm 5mm		5 400338 062353 >
------------------	--------------------------------	--	-------------------

- Magnetic nail holder
- Wooden handle with striking head

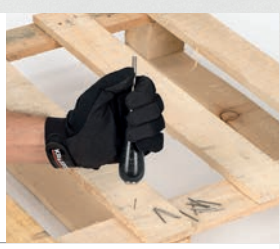

<b>KRT463011</b>	Size 4mm	5 400338 062599 >
------------------	-------------	-------------------

## WRECKING BARS

Kreator offers standard or heavy duty wrecking bars, ideal for heavy demolition work.



- High carbon steel
- Hex shank 16mm
- Hex-shaped bar
- Gooseneck nail puller

**HEX**  
**16**

<b>KRT465001</b>	Size 450mm	5 400338 061936 >
<b>KRT465002</b>	Size 600mm	5 400338 061943 >



**HD**

<b>KRT465003</b>	Size 750mm	5 400338 061950 >
<b>KRT465004</b>	Size 900mm	5 400338 061967 >

# Safety

## EYE PROTECTION

Kreator offers a variety of safety glasses and goggles to protect your eyes against external impacts, UV or welding light. See what fits you best.

- Suitable for people with glasses
- Impact resistant polycarbonate lens



**PC LENS** **EN 166**

**KRTS30001**



- Adjustable temples
- Side shields
- Impact resistant polycarbonate lens



**PC LENS** **EN 166**

**KRTS30002**



- Soft & flexible frame
- Direct ventilation
- Adjustable elastic strap
- Impact resistant polycarbonate lens



**PC LENS** **EN 166**

**KRTS30003**



- Welding goggles
- Indirect ventilation with 4 valves
- Adjustable elastic strap
- Easy change view



**EN 175**

**KRTS30005**



- Wide, unobstructed vision
- Impact resistant polycarbonate lens



**PC LENS** **EN 166**

**KRTS30006**



- Soft & flexible frame
- Indirect ventilation with 4 valves
- Adjustable elastic strap
- Impact resistant polycarbonate lens



**PC LENS** **EN 166**

**KRTS30004**



- Scratch resistant
- Impact resistant polycarbonate lens



**PC LENS** **EN 166**

**KRTS30007**





- Brightness & contrast
- Comfort wear with flexible non slip rubber
- Impact resistant polycarbonate lens



**PC LENS** **EN 166**

**KRTS30008**



- Adjustable temples
- Comfort wear
- Scratch resistant
- Impact resistant polycarbonate lens



**PC LENS** **EN 166**

**KRTS30009**



- Adjustable temples with string
- Comfort wear
- Scratch resistant
- Impact resistant polycarbonate lens



**PC LENS** **EN 166**

**KRTS30010**



## KNEE PADS

For extended kneeling when working on hardwood floors, ceramic bathrooms or other surfaces, Kreator provides padding with a variety of good knee pads. They all provides great comfort.

- Heavy duty impact resistant
- Suitable for general kneeling tasks
- Comfortable fit
- Professional protection



**2 PCS**

**KRTS20002**



## HEARING PROTECTION

Listen! Protect your ears from noisy work environments with the Kreator earmuffs and plugs. They will reduce the effects of noise that may lead to hearing damage or loss.

- Reinforced headband
- Comfortable fit with soft cushions
- Basic protection



**SNR 25** **EN 352-1**

**KRTS40001**



- Professional protection
- Adjustable headband
- Comfortable fit with soft cushions



**SNR 29** **EN 352-1**

**KRTS40002**



- Made with injected GEL
- Light weight quality
- Easy movement
- Solid webbing strap for easy on/off





**2 PCS GEL**

**KRTS20003**

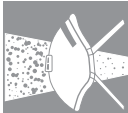

## DUST MASKS

Kreator presents various dust mask types to reduce or eliminate your exposure to any kind of dust during sanding of bare wood, non-lead painted surfaces and drywall.

Good 80%	Strong 94%	Very strong 99%
 <p><b>FFP1</b> ★</p>	 <p><b>FFP2</b> ★★</p>	 <p><b>FFP3</b> ★★★</p>
<p>Protection against non-toxic solid and liquid aerosols (ex. oil mists). Filters at least 80% of airborne particles.</p>	<p>Protection against non-toxic solid and liquid aerosols (ex. oil mists). Filters at least 94% of airborne particles.</p>	<p>Protection against non-toxic, low-to-average toxicity and high toxicity solid and liquid aerosols (ex. oil mists). Filters at least 99% of airborne particles.</p>

- Latex-free straps
- Aluminium nose clip for comfortable fit
- Hygiene masks



**10 PCS**

**KRTS10001** FFP /

5 400338 075070 >

- Latex-free straps
- Nose clip for comfortable fit



**3 PCS**

**KRTS10010** FFP1

5 400338 057021 >

CE EN149 +A1

- Latex-free straps
- Nose clip for comfortable fit



**3 PCS**

**KRTS10020** FFP2

5 400338 057045 >

CE EN149 +A1

- Easy breathing exhalation valve
- Latex-free straps
- Nose clip for comfortable fit



**2 PCS** VALVE

**KRTS1001V** FFP1

5 400338 057038 >

CE EN149 +A1

- Easy breathing exhalation valve
- Latex-free straps
- Nose clip for comfortable fit



**2 PCS** VALVE

**KRTS1002V** FFP2

5 400338 057052 >

CE EN149 +A1

- Easy breathing exhalation valve
- Latex-free straps
- Nose clip for comfortable fit



**2 PCS** VALVE

**KRTS1003V** FFP3

5 400338 057069 >

CE EN149 +A1

- Easy breathing exhalation valve
- Latex-free straps
- Nose clip for comfortable fit
- Odor reduction



**2 PCS** VALVE

**KRTS1001VC** FFP1

5 400338 074721 >

CE EN149 +A1

- Easy breathing exhalation valve
- Latex-free straps
- Nose clip for comfortable fit
- Odor reduction



**2 PCS** VALVE

**KRTS1002VC** FFP2

5 400338 074738 >

CE EN149 +A1

## HEAD PROTECTION

Kreator Head Protection collection includes a bump cap, face protection shield and set. All of these products are engineered to help protect the wearer's head from a variety of hazards.

- Basic protection
- Set for use of hand and/or power tools

**3**  
PIECES

EN166



EN149 +A1



EN352-1



KRTS60001



- Protection against bumping
- Easy to wear / casual basic protection



KRTS00001



- Protection against flying particles
- Easy to adjust

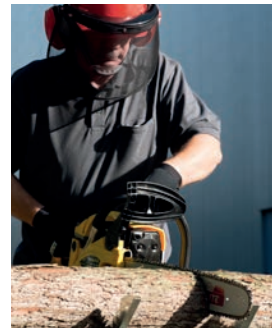

EN 1731 - EN 166

KRTS50001



## GLOVES

No matter what job you are executing, Kreator will give you the best protection, durability and comfort available. With a wide range of work, garden, technical and kids gloves we have you covered.



Construction, Masonry, Plumbing, Joinery, Roofing, Transportation, Cleaning, ...



Pruning, Weeding, Digging, Lawn mowing, Trimming, Shredding, Scarifying, Leaf blowing, ...



All round, Winter insulated, Chemicals, Chainsaw, Heavy duty, Cut resistance, ...



For kids who want to become real workingmen(women) like their parents.

## ALL KREATOR GLOVES COMPLY WITH EN 388 AND/OR EN 511 STANDARDS.

### EN 388: MECHANICAL HAZARDS



#### FIGURE KEY

- X ..... Untested performance level
- 0 ..... Nil
- 1 ..... Minimum
- 2 ..... Good
- 3 ..... Very good
- 4 and up ..... Excellent



## WORK GLOVES



**XL** **XXL**



- Breathable and stretchy Beihai® genuine pigskin leather palm
- Provides maximum comfort
- Pigskin leather knuckle
- Strip cotton back



<b>KRTW001XL</b> CONSTRUCTION LIGHT	Size 10	5 400338 055751 >
<b>KRTW001XXL</b> CONSTRUCTION LIGHT	Size 11	5 400338 055768 >

**S** **M**



- Grotech®/Clarino® synthetic leather with high abrasion resistance level combined with breathable, durable, washable performance
- Bignet® stretch-spandex back
- Classic pattern
- Shirred elastic back for snug fit



<b>KRTW002S</b> LIGHT COMFORT	Size 7	5 400338 055782 >
<b>KRTW002M</b> LIGHT COMFORT	Size 8	5 400338 055775 >

**M** **XL** **XXL**



- Grotech®/Clarino® synthetic leather with high abrasion resistance level combined with breathable, durable, washable performance
- Breathable and stretchy
- Beihai® genuine pigskin leather palm
- Bignet® stretch-spandex back
- Elastic band cuff
- Velcro adjustment



<b>KRTW003M</b> EXTRA COMFORT	Size 8	5 400338 055799 >
<b>KRTW003XL</b> EXTRA COMFORT	Size 10	5 400338 055805 >
<b>KRTW003XXL</b> EXTRA COMFORT	Size 11	5 400338 055812 >

**M** **XL** **XXL**



- Breathable and stretchy Beihai® genuine pigskin leather
- Drill cotton back
- Pigskin leather knuckle and rubberized safety cuff
- Soft and warm cotton lining
- Thinsulate™ insulation



<b>KRTW004M</b> CONSTRUCTION WINTER	Size 8	5 400338 055829 >
<b>KRTW004XL</b> CONSTRUCTION WINTER	Size 10	5 400338 055836 >
<b>KRTW004XXL</b> CONSTRUCTION WINTER	Size 11	5 400338 055843 >

**XL XXL**



- Beihai® genuine pig split leather
- Strip cotton back
- Pig split leather knuckle and safety cuff

CE EN 388  
3101

<b>KRTW005XL</b> CONSTRUCTION BASIC	Size 10	5 400338 055850 >
<b>KRTW005XXL</b> CONSTRUCTION BASIC	Size 11	5 400338 055867 >

**XL XXL**



- Knitted glove with tough latex coating
- Good grip in wet or dry conditions
- Excellent mechanical performance

CE EN 388  
3243

<b>KRTW006XL</b> STRONG GRIP	Size 10	5 400338 055874 >
<b>KRTW006XXL</b> STRONG GRIP	Size 11	5 400338 055881 >

**XL**



- 13 gauge knit glove with latex coating
- Flat dipping technology keeps the back of the hand well ventilated and cool



CE EN 388  
2132

<b>KRTW007XL</b> PRECISION GRIP	Size 10	5 400338 055898 >
------------------------------------	------------	-------------------

**XL XXL**



- Flexibility and dexterity PU coating on nylon seamless lining
- Knitted wrist cuff
- Minimal strike through reduces irritation and increases comfort level

CE EN 388  
3121

<b>KRTW008XL</b> PRECISION	Size 10	5 400338 055904 >
<b>KRTW008XXL</b> PRECISION	Size 11	5 400338 055911 >

**XL XXL**



- Cow split leather palm is exceptionally durable and puncture resistant
- Beihai® drill cotton back
- Cow split leather knuckle and safety cuff for extra protection

CE EN 388  
4133

<b>KRTW009XL</b> CONSTRUCTION	Size 10	5 400338 055928 >
<b>KRTW009XXL</b> CONSTRUCTION	Size 11	5 400338 055935 >





## GARDEN GLOVES



M XL



- Slightly thinner Latex palm for added dexterity and durable with acid and fertilizers
- Cotton lining with rubber coated
- Excellent gardening or landscaping glove



<b>KRTG001M</b> EXTRA GRIP	Size 8	5 400338 055997 >
<b>KRTG001XL</b> EXTRA GRIP	Size 10	5 400338 056000 >

M XL



- Breathable coating keeps hands cool and dry
- Foam latex coating on nylon seamless liner provides hands maximum comfort
- Knitted wrist cuff



<b>KRTG002M</b> COMFORT GRIP	Size 8	5 400338 056017 >
<b>KRTG002XL</b> COMFORT GRIP	Size 10	5 400338 056024 >

S M



- PVC dots on palm for anti-slip
- Cotton back that is washable and soft
- Knitted wrist cuff
- Fashionable design with great fit



<b>KRTG003S</b> LIGHT COMFORT	Size 7	5 400338 056031 >
<b>KRTG003M</b> LIGHT COMFORT	Size 8	5 400338 056048 >

M/L XL XXL



- Breathable & stretchy Beihai® genuine pigskin leather palm
- Pre-curved fingers
- Bignet® two layers stretch-spandex back offers exceptional dexterity
- Elastic band cuff and velcro adjustment



<b>KRTG004ML</b> HEAVY DUTY	Size 9	5 400338 056055 >
<b>KRTG004XL</b> HEAVY DUTY	Size 10	5 400338 056062 >
<b>KRTG004XXL</b> HEAVY DUTY	Size 11	5 400338 056079 >

**M XL**



EN 388  
CE 2121

- Grotech®/Clarino® synthetic leather with high abrasion resistance level combined with breathable, durable, washable performance
- Breathable foam inside softens the use of tools with good anti-vibration performance.
- Bignet® two layers stretch-spandex back
- Shirred elastic back for snug fit

<b>KRTG005M</b> EXTRA COMFORT	Size 8	 5 400338 056086 >
<b>KRTG005XL</b> EXTRA COMFORT	Size 10	 5 400338 056093 >

**XL**



EN 388  
CE 011X

- Canvas glove with knitted wrist cuff
- Black PVC dot coated version for improved grip



<b>KRTG006XL</b> SOFT TOUCH	Size 10	 5 400338 056109 >
--------------------------------	------------	--



**TECHNICAL GLOVES**



**XL XXL**



EN 388  
CE 3121

- Grotech®/Clarino®/Protech® synthetic leather with high abrasion resistance level combined with breathable, durable and washable performance
- Pre-curved fingers
- Bignet® two layer stretch-spandex back
- Elastic band cuff and velcro adjustment

<b>KRTT001XL</b> ALL-ROUND	Size 10	 5 400338 055416 >
<b>KRTT001XXL</b> ALL-ROUND	Size 11	 5 400338 055423 >

**XL**



EN 388  
CE 2221

- Neoprene padding synthetic leather gloves with neoprene knuckle abating impact
- Nova® neoprene cuff with PVC adjustment

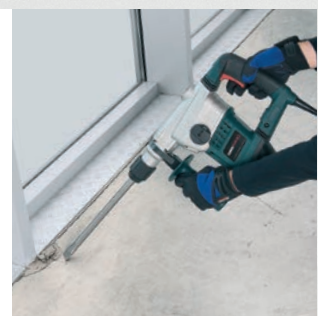

<b>KRTT002XL</b> HEAVY IMPACT	Size 10	 5 400338 056116 >
----------------------------------	------------	--



**XL**



- Inpac® superior PU palm with washable performance
- Inpac® superior PU patch on finger back
- Bignet® stretch-spandex back
- Elastic band cuff and Velcro adjustment



CE EN 388  
2111

**KRTT003XL**  
PRECISION LIGHT

Size 10

5 400338 056123 >

**XL**



- Classical silicone pattern anti-slip glove with additional patch between thumb and index finger to strengthen abrasion resistance
- Neoprene back



CE EN 388  
3121

**KRTT004XL**  
ALL-ROUND  
EXTRA GRIP

Size 10

5 400338 056130 >

**XL**

**XXL**



- Hypro® string glove for excellent cut-resistance
- Super fit PU dipped
- Knitted wrist cuff



CE EN 388  
4442

**KRTT005XL**  
CUT-RESISTANT

Size 10

5 400338 056147 >

**KRTT005XXL**  
CUT-RESISTANT

Size 11

5 400338 056154 >

**XL**

**XXL**



- Goat leather with PVC double palm
- Spandex back
- Chainsaw material on left hand



CE EN 388  
2122 Class 1A

**KRTT006XL**  
CHAINSAW

Size 10

5 400338 056161 >

**KRTT006XXL**  
CHAINSAW

Size 11

5 400338 056178 >

**XL**

**XXL**



- Grotech®/Clarino®/Protech® synthetic leather palm with textured PVC full patch strengthens durability as well as slip resistance performance



CE EN 388  
3121

**KRTT007XL**  
HEAVY DUTY

Size 10

5 400338 056185 >

**KRTT007XXL**  
HEAVY DUTY

Size 11

5 400338 056192 >

**XL** **XXL**



- Soft and stretchy Beihai® genuine goat leather
- Pre-curved fingers
- Bignet® two layers stretch spandex back
- Flexible Nova® neoprene knuckle and cuff design
- Plastic band cuff and velcro adjustment
- Thinsulate™ insulation



<b>KRTT008XL</b> ALL-ROUND WINTER	Size 10	 5 400338 056208 >
<b>KRTT008XXL</b> ALL-ROUND WINTER	Size 11	 5 400338 056215 >



**KIDS GLOVES**



**AGE**  
6-12



- PVC dots on palm for anti-slip
- Cotton back that is washable and soft
- Knitted wrist cuff



<b>KRTK001</b>	Age 6 - 12	 5 400338 056222 >
----------------	---------------	-----------------------

**AGE**  
6-12



- Cow split leather palm
- Beihai® drill cotton back
- Cow split leather knuckle and safety cuff



<b>KRTK002</b>	Age 6 - 12	 5 400338 056239 >
----------------	---------------	-----------------------

**AGE**  
6-12



- Beihai® genuine pig split leather
- Strip cotton back
- Pig split leather knuckle and safety cuff



<b>KRTK003</b>	Age 6 - 12	 5 400338 056246 >
----------------	---------------	-----------------------

# Transport, trestles, workbenches, tool cabinets & tarpaulins

## TRANSPORT CART

Move furniture with great ease.



4x SWIVEL WHEEL 360°

- Max. load: 200kg
- Platform size: 300 x 600mm
- Height: 110mm
- Hard PP wheels: Ø 75mm
- With carrying handle
- 4x round anti-slip cover

KRT670001

Material  
Wood



## QUICK FOLDING CARTS

Fold up quickly for easy storage.



- Max. load: 90kg
- Platform size: 250 x 355mm
- Open height: 1080mm
- Folded height: 710mm
- Wheels: Ø 150mm

KRT670201

Material  
Aluminium



## PLATFORM CARTS

Perfect for large and heavy loads.



- Max. load: 150kg
- Platform size: 470 x 730mm
- Height: 850mm
- Rubber wheels: Ø 100mm

2x SWIVEL WHEEL 360°

KRT670101

Material  
Steel



- Max. load: 300kg
- Platform size: 600 x 900mm
- Height: 870mm
- Rubber wheels: Ø 120mm

2x SWIVEL WHEEL 360°



KRT670102

Material  
Steel



- Max. load: 45kg
- Platform size: 240 x 390mm
- Open height: 965mm
- Folded height: 685mm
- Wheels: Ø 140mm



KRT670202

Material  
Aluminium



- Max. load: 80kg
- Platform size: 240 x 480mm
- Open height: 980mm
- Folded height: 700mm
- Wheels: Ø 170mm



Material  
Aluminium platform  
Steel frame

KRT670203



- Max. load: 120kg
- Platform size: 350 x 485mm
- Open height: 1110mm
- Folded height: 825mm
- Wheels: Ø 175mm



Material  
Aluminium platform  
Steel frame

KRT670204



# HAND TRUCKS

Safely transport boxes or crates.

1

- Max. load :200kg
- Platform size: 210 x 310mm
- Height: 1190mm
- Pneumatic tyres: Ø 255mm



2

- Max. load: 200kg
- Platform size: 200 x 350mm
- Height: 1260mm
- Pneumatic tyres: Ø 255mm



FOLDABLE

2

CAN CARRY ROUND OBJECTS



KRT670301

Material Steel



KRT670302

Material Steel



3

- Max. load: 200kg
- Platform size: 290 x 310mm
- Height: 1130mm
- Folded height: 800mm
- Pneumatic tyres: Ø 255mm



RETRACTABLE HANDLE

FOLDABLE

5

- Max. load: 200kg
- Platform size: 230 x 300mm
- Height: 1400mm
- Pneumatic tyres: Ø 255mm

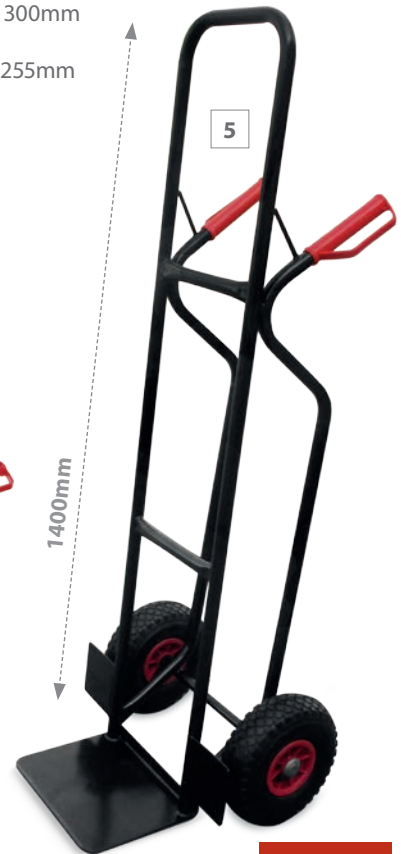

EXTRA HIGH

KRT670303

Material Steel



4

- Max. load: 200kg
- Platform size: 205 x 300mm
- Height: 1450mm
- Pneumatic tyres: Ø 255mm

EXTRA HIGH



KRT670304

Material Aluminium



KRT670305

Material Steel



## TRESTLES

Solid support for large workpieces.

- Max. load: 125kg/pc
- Open size size: 995 x 480 x 780mm
- Folded height: 995 x 100 x 65mm
- Working height: 780mm
- With carrying handle
- Anti-slip foam



**2**  
PCS

FOLDABLE

KRT671001

Material  
Steel



ADJUSTABLE  
HEIGHT

FOLDABLE

- Max. load: 150kg
- Open size: 1010 x 500 x 645mm
- Folded size: 995 x 100 x 65mm
- Working height: 645 - 910mm
- With carrying handle
- Anti-slip foam
- Galvanized steel

**1**  
PC

KRT671002

Material  
Steel



- Max. load: 180kg
- Opening size: 685 x 580 x 800mm
- Working height: 800 - 1300mm



ADJUSTABLE  
HEIGHT

**1**  
PC

KRT671003

Material  
Steel



## WORKBENCHES

Securely clamp workpieces of different shapes.

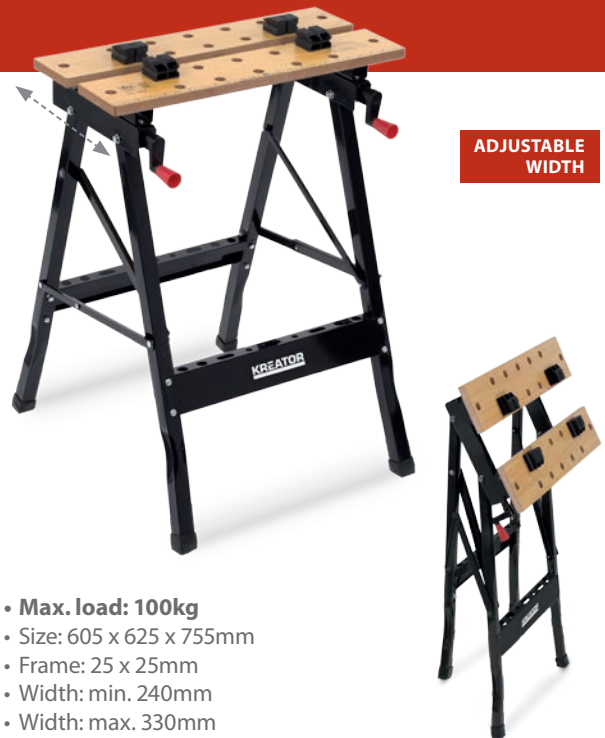

ADJUSTABLE  
WIDTH

FOLDABLE

- Max. load: 100kg
- Size: 605 x 625 x 755mm
- Frame: 25 x 25mm
- Width: min. 240mm
- Width: max. 330mm
- Black powder coated steel
- MDF worktop

KRT672001

Material  
Steel / MDF





**ADJUSTABLE WIDTH**

**ADJUSTABLE HEIGHT**

**FOLDABLE**

- Max. load: **100kg** (H770mm)
- 45kg** (H650mm)
- 70kg** (H600mm)
- 18kg** (H470mm)
- 15kg** (H390mm)
- 40kg** (H210mm)

- Size: 605 x 715 x 770mm
- Width: min. 300mm
- Width: max. 475mm
- Black powder coated steel
- MDF worktop

**KRT672002**

Material  
Steel / MDF



## TOOL CABINETS

Neat and orderly storage of tools.

**7x DRAWER** **25kg MAX. WEIGHT / SHELF**



- Size: 660 x 400 x 870mm
- Synthetic organiser platform
- 7x high quality drawer
- Max. weight/shelf: 25kg
- With keylock

**2x SWIVEL WHEEL WITH BRAKE**

**KRT653003**

Material  
Steel



**2x SWIVEL WHEEL WITH BRAKE**



- Size top chest: 600 x 260 x 340mm
- Size roller cabinet: 616 x 330 x 658mm
- 5x hook
- 8x drawer
- With keylock



**348 PCS** **7x DRAWER**

**25kg MAX. WEIGHT / SHELF**

**2x SWIVEL WHEEL WITH BRAKE**

- Size: 660 x 400 x 870mm
- Synthetic organiser platform
- 7x high quality drawer
- Max. weight/shelf: 25kg
- With keylock

- 1x 1/4" ratchet handle, carbon steel
- 1x 1/4" spinner handle, carbon steel
- 1x 1/4" sliding T-bar, carbon steel
- 1x 1/4" universal joint, carbon steel
- 1x extension bar 1/4" x 4", carbon steel
- 13x 1/4" socket: 4-4.5-5-5.5-6-7-8-9-10-11-12-13-14mm, carbon steel
- 1x 1/2" ratchet handle, carbon steel
- 1x 1/2" sliding bar, carbon steel
- 1x 1/2" universal joint, carbon steel
- 1x extension bar 1/2" x 5", carbon steel
- 15x 1/2" socket: 10-11-12-13-15-16-17-19-20-21-22-24-27-30-32mm, carbon steel
- 9x combination spanner: 8-9-10-11-12-13-14-17-19mm, carbon steel
- 12x screwdriver: PH2\*38, PH0\*75, PH1\*100, PH2\*125, SL6\*38, SL4\*75, SL5\*100, SL6\*125, PZ2\*38, PZ0\*75, PZ1\*100, PZ2\*125, CR-V
- 4x insulated screwdriver: SL3\*75, SL4\*100, PH1\*80, PH2\*100, CR-V
- 8x precision screwdriver: PH00, PH0, SL2.5, SL3, T5, T6, T7, T8, CR-V
- 10x TX key: T9-T10-T15-T20-T25-T27-T30-T40-T45-T50, carbon steel
- 4x plier: 10" locking plier, 10" water pump plier, 7" combination plier, 6" long nose plier, carbon steel
- 1x 9.5" riveter
- 100x riveter: 25x 2.4mm / 25 x 3.2mm / 25 x 4mm / 25 x 4.8mm
- 3x empty tray to fill drawer
- 160x screws & plugs: 30x screws 3\*30 Z/P - 25x screw 3.5\*32 Z/P - 15x screw 4\*38 Z/P
- 10x screw 5\*50 Z/P - 30x plug E5 grey - 25x plug E6 grey - 15x plug E7 grey
- 10x plug E8 grey

**KRT653002**

Material  
Steel



**KRT653004**

Material  
Steel



# TARPAULINS

Protective cover against harsh weather conditions and dirt.



70g/m2

- Double sided blue/green
- Aluminium eyelets
- Reinforced and sealed borders with thread

KRT660101	1.5 x 6m (1.40 x 5.85m)	5 400338 067419 >
KRT660102	2 x 3m (1.90 x 2.90m)	5 400338 067426 >
KRT660103	3 x 4m (2.90 x 3.85m)	5 400338 067433 >
KRT660104	4 x 5m (3.85 x 4.85m)	5 400338 067440 >
KRT660105	4 x 6m (3.85 x 5.85m)	5 400338 067457 >
KRT660106	5 x 8m (4.80 x 7.80m)	5 400338 067464 >
KRT660107	6 x 10m (5.80 x 9.80m)	5 400338 067471 >
KRT660108	8 x 12m (7.75 x 11.80m)	5 400338 067488 >
KRT660109	10 x 15m (9.70 x 14.80m)	5 400338 067495 >



120g/m2

- Double sided green/blue
- Reinforced corners
- Aluminium eyelets
- Reinforced and sealed borders with thread

KRT660201	2 x 3m (1.90 x 2.90m)	5 400338 067501 >
KRT660202	2 x 4m (1.90 x 3.90m)	5 400338 067518 >
KRT660203	3 x 6m (2.85 x 5.85m)	5 400338 067525 >
KRT660204	4 x 4m (3.85 x 3.90m)	5 400338 067532 >
KRT660205	5 x 8m (4.80 x 7.80m)	5 400338 067549 >
KRT660206	6 x 10m (5.80 x 9.80m)	5 400338 067556 >
KRT660207	10 x 12m (9.70 x 11.80m)	5 400338 067563 >



180g/m2

- Double sided grey/black
- Reinforced corners
- Aluminium eyelets
- Reinforced and sealed borders with thread

KRT660301	2 x 3m (1.90 x 2.90m)	5 400338 067570 >
KRT660302	3 x 4m (2.90 x 3.85m)	5 400338 067587 >
KRT660303	4 x 5m (3.85 x 4.85m)	5 400338 067594 >
KRT660304	5 x 8m (4.80 x 7.80m)	5 400338 067600 >
KRT660305	6 x 10m (5.80 x 9.80m)	5 400338 067617 >

## PLASTIC COVERS

Protect all indoor and outdoor furniture from paint drops, water, dust,...



STANDARD QUALITY 0.01mm

- Transparant

KRT661001	4 x 5m	5 400338 067143 >
-----------	--------	-------------------

PREMIUM QUALITY 0.03mm

KRT662001	4 x 5m	5 400338 067167 >
-----------	--------	-------------------

HEAVY DUTY QUALITY 0.10mm

KRT663001	2 x 6m	5 400338 067174 >
KRT663002	3 x 6m	5 400338 067181 >
KRT663003	4 x 6m	5 400338 067198 >
KRT663004	6 x 6m	5 400338 067204 >
KRT663005	6 x 10m	5 400338 067211 >

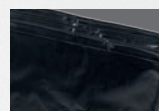

HEAVY DUTY QUALITY 0.10mm

- Black

KRT664001	4 x 6m	5 400338 067228 >
KRT664002	6 x 6m	5 400338 067235 >
KRT664003	6 x 8m	5 400338 067242 >



**VIC. VAN ROMPUY nv**

JOSEPH VAN INSTRAAAT 9  
2500 LIER - BELGIUM  
TEL +32 (0)3 292.92.92  
FAX +32 (0)3 292.92.72  
E-MAIL: INFO@VARO.COM

WWW.VARO.COM  
WWW.KREATOR.BE

**OFFICES:**

IBERICA BRICOLAGE S.L. - ESPAÑA  
ASIA PACIFIC HONG KONG Ltd / SHANGHAI PRC  
AUSTRALIA Pty Ltd / GERMANY GmbH