

**2 YEAR  
WARRANTY**



**POWERPLUS**

DESIGNED AND MARKETED BY VARD





## Cordless drills/screwdrivers

POW30620	Cordless drill/screwdriver	14.4V		3
POW30625	Cordless drill/screwdriver	18V	2 batt	3
POW30633	Cordless drill/screwdriver	14.4V	2 batt	4
POW30644	Cordless drill/screwdriver	18V	2 batt	4
POW30646	Cordless drill/screwdriver	18V	2 batt - 1h	4
POW326	Cordless screwdriver	4.8V	50 pcs	5
POW3270	Cordless screwdriver	4.8V		5

## Drills

POW30002	Impact drill	500W		7
POW30070	Impact drill	600W		7
POW30075	Impact drill	750W		8
POW30080	Impact drill	1050W		8
POW302	Bench drill	350W		9
POW30540	Hammer drill	400W		9
POW30543	Hammer drill	900W		10
POW30546	Hammer drill	1200W		10
POW30580	Demolition hammer	1600W		11

## Sanding & grinding

### Sanding tools

POW4001	Palm sander	135W		13
POW403	Triangular sander	180W		13
POW4060	Rotating sander	480W		14
POW411	Belt sander	800W		14
POW4012	Finishing sander	135W		15
POW4014	Finishing sander	135W		15

### Grinding tools

POW2040	Angle grinder	500W	115mm	16
POW2085	Angle grinder	710W	115mm	17
POW2086	Angle grinder	900W	125mm	17
POW2087	Angle grinder	2150W	230mm	17
POW5100	Bench grinder / dry	120W	125mm	18
POW5101	Bench grinder / dry	150W	150mm	18
POW5102	Bench grinder / dry	350W	200mm	19
POW5103	Bench grinder / wet & dry	250W		19
POW222	Wall slotter	1700W	150mm	20

## Sawing & woodworking

POW1003	Jigsaw	350W		22
POW1010	Jigsaw	450W		22
POW1015	Jigsaw	650W		22
POW162X	Router	1020W		23
POW1520	Electric planer	600W		23
POW8002	Mitre saw	1400W	210mm	24
POW8041	Mitre saw + upptable	1200W	210mm	24
POW8130	Mitre saw	1500W	210mm	25
POW8136	Mitre saw + table	2000W	255mm	26
POW8561	Table saw	1500W	250mm	27
POW1044	Circular saw	1200W	185mm	28

## Specials

POW0343	Vacuum cleaner	1200W		30
POW1905	Mixer	1200W		30
POW1820	Multitool	135W		31
POW18205	Accessories for multitool			31
POW404	Polisher	110W	240mm	32
POW462	Welding machine	160A		32
POW703	Heat gun	1600W		33
POW706	Heat gun	2000W		33
POW721	Hot glue gun	78W		34
POW726	Soldering gun	175W		34
POW737	Nail/staple gun			34
POW751	Paint spray gun	100W		35
POW754	Paint spray gun	600W		35
POW900	Hoist	500W		37
POW901	Hoist	1000W		37
POW902	Hoist	1050W		38
POW903	Hoist	1300W		38
POW910	Pivoting arm for hoist			38
POW7490	Tile cutter	600W	180mm	36

## Power generators

POW5633	Power station 4-IN-1	900A		40
POW470	Power generator	720W		40

## Accessories

Accessories				41
-------------	--	--	--	----



# Powerplus Cordless drills



**Drills/screwdrivers 3-4**  
BOORMACHINES/SCHROEVENDRAAIERS  
PERCEUSES/VISSEUSES  
BOHRSCHRAUBER  
TALADROS/ATORNILLADORES

**Screwdrivers 5**  
SCHROEVENDRAAIERS  
TOURNEVIS  
SCHRAUBER  
ATORNILLADORES

**POWERPLUS**

DESIGNED AND MARKETED BY VARD



# Drills/ screwdrivers



LED  
worklight

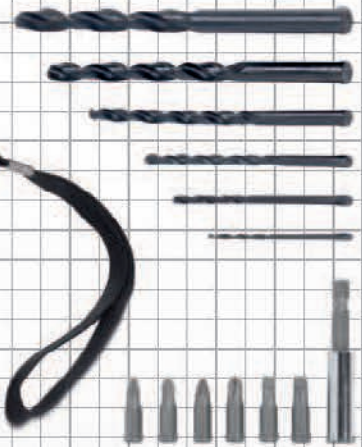

**POW30620 DRILL/SCREWDRIVER**  
**14.4V**

RATED VOLTAGE	14.4V
BATTERY CAPACITY	800mAh / NiCd
CHARGING TIME	3-5h
ROTATION SPEED	0-550min <sup>-1</sup>
CHUCK TYPE	10mm keyless chuck

5 400338 059001 >

**BMC**  
INCL. BATT.

*Included:*  
6x drill, 6x bit, 1x magnetic bit holder,  
1x charger, 1x batt



LED  
worklight

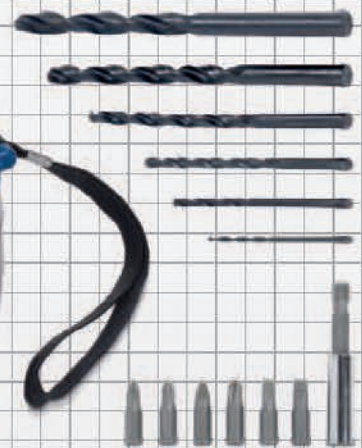

**POW30625 DRILL/SCREWDRIVER**  
**18V**

RATED VOLTAGE	18V
BATTERY CAPACITY	2x 800mAh / NiCd
CHARGING TIME	3-5h
ROTATION SPEED	0-550min <sup>-1</sup>
CHUCK TYPE	10mm keyless chuck

5 400338 059018 >

**BMC**  
INCL. BATT.

**2X  
BATTERY**

*Included:*  
6x drill, 6x bit, 1x magnetic bit holder,  
1x charger, 2x batt



# Drills/ screwdrivers

## QUICK OVERVIEW

- 1 CHUCK FOR DRILLING/DRIVING
- 3 TORQUE SETTINGS RING 20 + 1
- 2 LEFT/RIGHT FUNCTION

POW30633 DRILL/SCREWDRIVER

**14.4V**

RATED VOLTAGE	14.4V
BATTERY CAPACITY	2x1200mAh / NiCd
CHARGING TIME	3-5h
ROTATION SPEED	0-550min <sup>-1</sup>
CHUCK TYPE	10mm keyless Sanou chuck



**Included:**

6x drill, 6x bit, 1x magnetic bit holder,  
1x charger, 2x batt



POW30644 DRILL/SCREWDRIVER

**18V**

RATED VOLTAGE	18V
BATTERY CAPACITY	1200mAh / NiCd
CHARGING TIME	3-5h
ROTATION SPEED	0-550min <sup>-1</sup>
CHUCK TYPE	10mm keyless Sanou chuck



**Included:**

6x drill, 6x bit, 1x magnetic bit holder,  
1x charger, 2x batt



POW30646 DRILL/SCREWDRIVER

**18V**

RATED VOLTAGE	18V
BATTERY CAPACITY	1200mAh / NiCd
CHARGING TIME	1h
ROTATION SPEED	0-550min <sup>-1</sup>
CHUCK TYPE	10mm keyless Sanou chuck



**Included:**

6x drill, 6x bit, 1x magnetic bit holder,  
1x quick charger, 2x batt





# Screwdrivers



**Worklight**

**3 angle positions**

**Soft grip handle**

**+ 50 pcs accessories**

**POW326 SCREWDRIVER**  
**4.8V**

RATED VOLTAGE	4.8V
BATTERY CAPACITY	700mAh / NiCd
CHARGING TIME	5-8h
ROTATION SPEED	200min <sup>-1</sup>
LEFT/RIGHT FUNCTION	✓

5 400338 022685 >

**BMC**  
INCLUDED

**Included:**  
1x screwdriver, 1x charger, 1x flexible shaft,  
1x screw bit adaptor, 3x drill bit, 6x long screw bit,  
28x short screw bit, 1x adaptor, 8x socket



**Worklight**

**Battery indicator**

**POW3270 SCREWDRIVER**  
**4.8V**

RATED VOLTAGE	4.8V
BATTERY CAPACITY	600mAh / NiCd
ROTATION SPEED	180min <sup>-1</sup>
CHARGING TIME	3-5h

5 400338 057564 >

**Included:**  
4x 50mm bit (PZ1, PZ2, SL4.5, SL6)

**4x 50mm Bit**



# Powerplus Drills

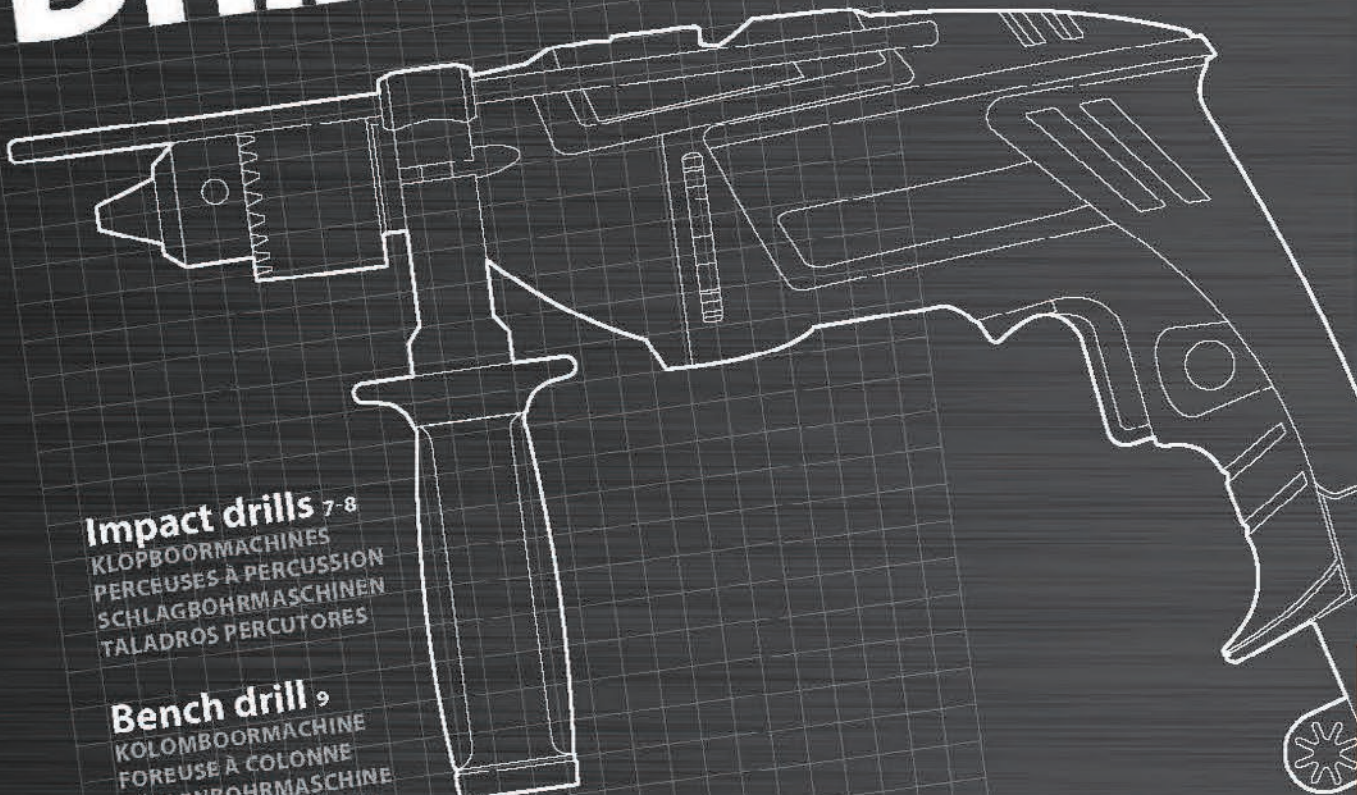

**Impact drills** 7-8  
KLOPBOORMACHINES  
PERCEUSES À PERCUSSION  
SCHLAGBOHRMASCHINEN  
TALADROS PERCUTORES

**Bench drill** 9  
KOLOMBOORMACHINE  
FOREUSE À COLONNE  
SÄULENBOHRMASCHINE  
TALADRO DE COLUMNA

**Hammer drills** 9-10  
BOORHAMERS  
MARTEAUX PERFORATEURS  
BOHRHÄMMER  
MARTILLOS PERFORADORES

**Demolition hammer** 11  
BREEKHAMER  
MARTEAU-PIQUEUR  
ABBRUCHHAMMER  
MARTILLO DEMOLICIÓN

**POWERPLUS**  
DESIGNED AND MARKETED BY VARD



# Impact drills



Chuck key

## POW20002 IMPACT DRILL 500W

VOLTAGE - FREQUENCY	230-240V~ 50Hz
RATED POWER	500W
ROTATION SPEED	0-3000min <sup>-1</sup>
CHUCK TYPE	13 mm key chuck



**Included:**

1x auxiliary handle, 1x depth stop,  
1x chuck key

### QUICK OVERVIEW

- 1 IMPACT DRILL FUNCTION SWITCH
- 2 DEPTH STOP
- 3 KEYLESS CHUCK
- 4 LEFT/RIGHT FUNCTION
- 5 SPEED ADJUSTMENT WHEEL
- 6 LOCK-ON BUTTON



## POW30070 IMPACT DRILL 600W

VOLTAGE - FREQUENCY	230V~ 50Hz
RATED POWER	600W
ROTATION SPEED	0-3000min <sup>-1</sup>
CHUCK TYPE	13mm keyless Sanou chuck + lock
LEFT/RIGHT FUNCTION	✓



**Included:**

1x auxiliary handle, 1x depth stop



# Impact drills



Keyless Sanou chuck



## POW30075 IMPACT DRILL 750W

VOLTAGE - FREQUENCY	230V~ 50Hz
RATED POWER	750W
ROTATION SPEED	0-3000min <sup>-1</sup>
CHUCKTYPE	13mm keyless Sanou chuck
LEFT/RIGHT FUNCTION	✓



5 400338 057212 >

*Included:*  
1x auxiliary handle, 1x depth stop



Speed control + left/right function



## POW30080 IMPACT DRILL 1050W

VOLTAGE - FREQUENCY	230V~ 50Hz
RATED POWER	1050W
ROTATION SPEED	0-2800min <sup>-1</sup>
CHUCKTYPE	13mm keyless chuck + lock
LEFT/RIGHT FUNCTION	✓



5 400338 057229 >



*Included:*  
1x auxiliary handle, 1x depth stop



## Bench drill

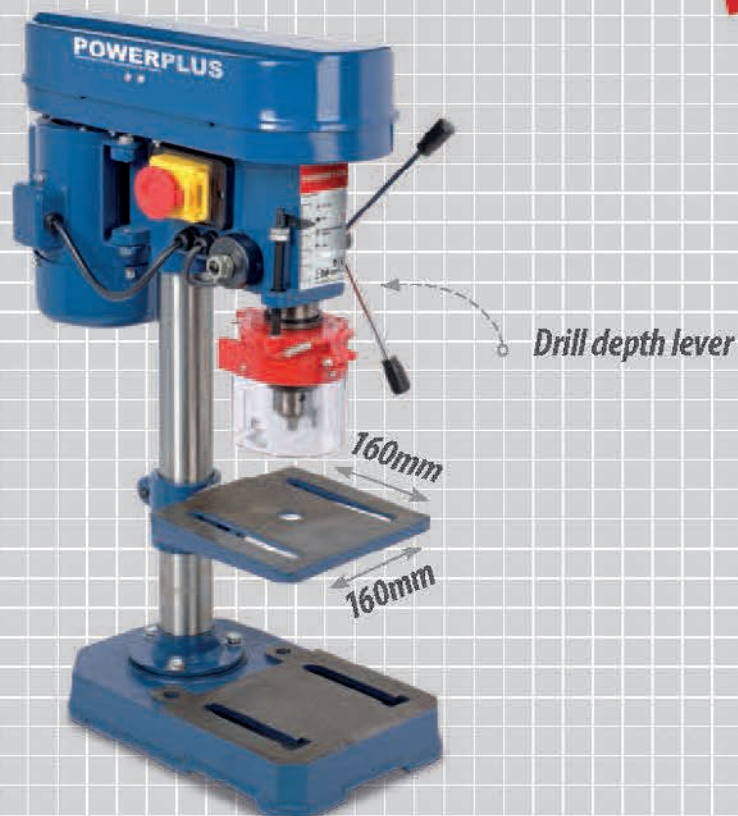

### POW302 BENCH DRILL 350W

RATED POWER	350W
5 SPEED	580-2650min <sup>-1</sup>
HEIGHT	570mm
CHUCK TYPE	13mm key chuck
TABLE SIZE	160x160mm



#### Included:

3x auxiliary handle, 2x hex key (3mm, 4mm),  
1x set: 8x20mm bolt with spring & washer,  
1x chuck key



**Drill function**  
**Hammer/drilling function**  
**Chisel function**

## Hammer drill

### POW30540 HAMMER DRILL 400W

VOLTAGE - FREQUENCY	220-240V ~ 50Hz
RATED POWER	400W
ROTATION SPEED	0-1100min <sup>-1</sup>
CHUCK TYPE	10mm key chuck
CONNECTION TYPE	SDS-Plus type
IMPACTS PER MINUTE	0-4800
MAX. DRILL CAPACITY	steel: 8mm concrete: 10mm wood: 16mm

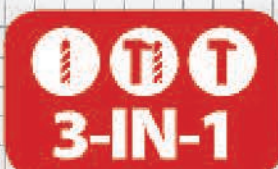



# Hammer drills



**Drill function**  
**Hammer/drilling function**  
**Chisel function**

POW30543 HAMMER DRILL

**900W**

VOLTAGE - FREQUENCY	230-240V ~ 50Hz
RATED POWER	900W
ROTATION SPEED	850min <sup>-1</sup>
CHUCKTYPE	26mm key chuck
IMPACTS PER MINUTE	4100
MAX. DRILL CAPACITY	steel: 13mm concrete: 26mm wood: 40mm



**Included:**

3x SDS-PLUS type drill, 2x SDS-PLUS type chisel,  
 1x 13mm key chuck + adaptor, 1x chuck key,  
 1x auxiliary handle, 1x dust cap, 1x depth stop,  
 1x spanner, 1x grease pot



**Drill function**  
**Hammer/drilling function**  
**Chisel function**

POW30546 HAMMER DRILL

**1200W**

VOLTAGE - FREQUENCY	230-240V ~ 50Hz
RATED POWER	1200W
ROTATION SPEED	850min <sup>-1</sup>
CHUCKTYPE	13mm key chuck
IMPACTS PER MINUTE	4100
MAX. DRILL CAPACITY	steel: 26mm concrete: 13mm wood: 40mm



**Included:**

3x SDS-PLUS type DRILL, 2x SDS-PLUS type chisel,  
 1x 13mm key chuck + adaptor, 1x chuck key,  
 1x auxiliary handle, 1x dust cap, 1x depth stop,  
 1x spanner, 1x grease pot





# Demolition hammer

## QUICK OVERVIEW

- 1 SDS HEX SYSTEM
- 2 FLAT CHISEL
- 3 POINTED CHISEL
- 4 ADJUSTABLE AUXILIARY HANDLE

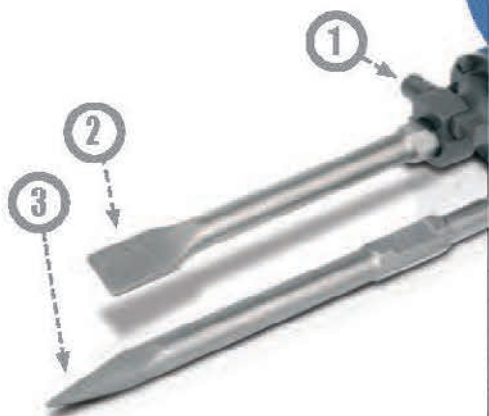

POW30580CF FLAT CHISEL (p. 41)



410mm x  
ø30mm

POW30580CP POINTED CHISEL (p. 41)



410mm x  
ø30mm

SDS hex system 30mm  
Full metal body



POW30580 DEMOLITION HAMMER

**1600W**

VOLTAGE - FREQUENCY	230V ~ 50Hz
RATED POWER	1600W
IMPACTS PER MINUTE	1500
CONNECTION TYPE	SDS HEX



**Included:**  
1x chisel (flat 410mm), 1x chisel (pointed 410mm),  
1x auxiliary handle, 1x thin spanner, 2x male key,  
1x grease pot



# Sanding & Grinding

**Palm sander** 13  
HANDPALMSCHUURMACHINE  
PONCEUSE À MAIN  
HANDSCHLEIFER  
LIJADORA A MANO

**Triangular sander** 12  
DRIEHOEKSCHUURMACHINE  
PONCEUSE TRIANGULAIRE  
DREIECKSCHLEIFER  
LIJADORA TRIANGULAR

**Rotating sander** 4  
ROTERENDE SCHUURMACHINE  
PONCEUSE ROTATIVE  
EXZENTERSCHLEIFER  
LIJADORA ROTO-ORBITAL

**Belt sander** 14  
BANDSCHUURMACHINE  
PONCEUSE À BANDE  
BANDSCHLEIFER  
LIJADORA DE BANDA

**Finishing sander** 15  
VLAKSCHUURMACHINE  
PONCEUSE VIBRANTE  
SCHWINGSCHLEIFER  
LIJADORA ORBITAL

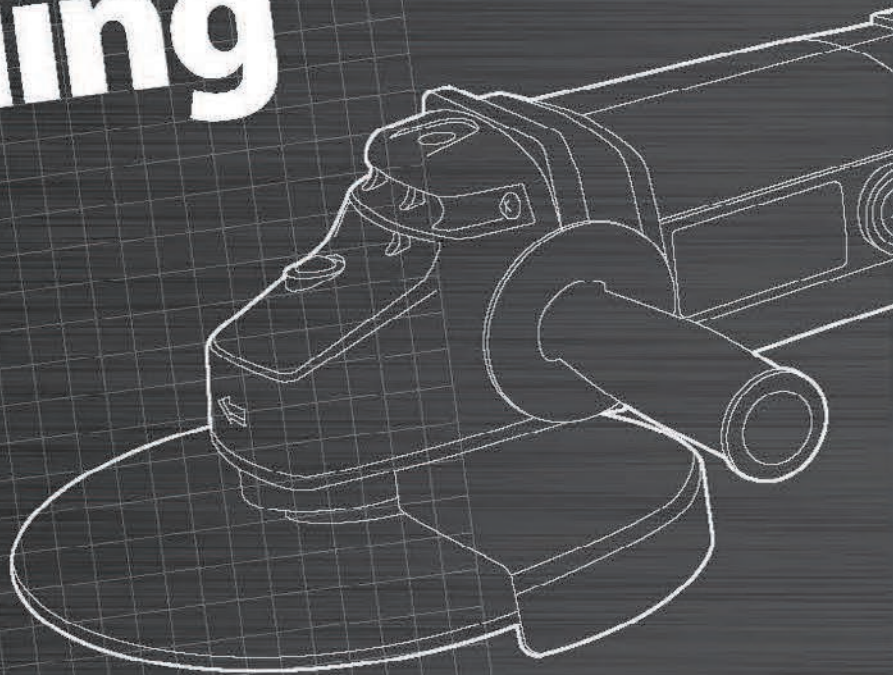

**Angle grinders** 16-17  
HAAKSE SLIJERS  
MEULEUSES D'ANGLE  
WINKELSCHLEIFER  
AMOLADORAS

**Bench grinders** 18-19  
BANKSLIJPMOLENS  
TOURETS  
TISCHSCHLEIFMASCHINEN  
ESMERILADORAS DE BANCO

**Wall slotter** 20  
MUURFREES  
RAINUREUSE  
MAUERNUTFRÄSE  
RANURADORA DE PARED

**POWERPLUS**  
DESIGNED AND MARKETED BY VARD



# Powerplus Sanding tools



Hook & loop  
system

Soft grip

Palm sander

POW4001 PALM SANDER  
**135W**

VOLTAGE - FREQUENCY	230V~ 50Hz
RATED POWER	135W
OSCILLATION SPEED	26000min <sup>-1</sup>
SANDING SURFACE	140x140x80mm



**Included:**

10x sandpaper (3x G80/3x G120/4x G240),  
1x dust adaptor



Dust adaptor



+ 10  
sandpapers



Hook & loop  
system

Triangular sander

POW403 TRIANGULAR SANDER  
**180W**

VOLTAGE - FREQUENCY	230-240V~ 50Hz
RATED POWER	180W
OSCILLATION SPEED	20000min <sup>-1</sup>
SANDING SURFACE	90x90x90mm



**Included:**

1x sandpaper (G80), 1x dust adaptor



Dust extraction

Dust adaptor





## Rotating sander



Hook & loop system

Adjustable auxiliary handle

Dust proof switch

Soft grip

Electronic speed control



Grinding/sanding plate

+ 1 dust bag

POW4060 ROTATING SANDER

**480W**

VOLTAGE · FREQUENCY 230V ~ 50Hz

RATED POWER 480W

OSCILLATION SPEED 8000-28000min<sup>-1</sup>

SANDING DIAMETER Ø125mm



5 400338 051159 >

**Included:**

1x sandpaper (G80), 1x dust bag

## Belt sander

Guide handle

Soft grip

Adjusting knob

+ 1 dust bag



POW411 BELT SANDER

**800W**

VOLTAGE · FREQUENCY 230V ~ 50Hz

RATED POWER 800W

BELT SPEED 290m/min

BELT SIZE 457x76mm



5 400338 029080 >

**Included:**

1x sanding belt, 1x dust bag



# Finishing sanders



Paper clamps



Dust adaptor

POW4012 FINISHING SANDER

**135W**

VOLTAGE - FREQUENCY	230-240V~ 50Hz
RATED POWER	135W
OSCILLATION SPEED	24000min <sup>-1</sup>
SANDING SURFACE	187x90mm



5 400338 054044 >

*Included:*

1x sand paper (G80), 1x dust adaptor



POW4014 FINISHING SANDER

**135W**

VOLTAGE - FREQUENCY	230V~ 50Hz
RATED POWER	135W
OSCILLATION SPEED	23000min <sup>-1</sup>
SANDING SURFACE	187x90mm



5 400338 059476 >

*Included:*

1x sand paper (G120), 1x dust adaptor

Soft grip



Dust adaptor

Paper clamps



# Powerplus Grinding tools

## Angle grinders



### QUICK OVERVIEW

- 1 AUXILIARY HANDLE
- 2 SAFETY GUARD
- 3 SPINDLE LOCK



DISC NOT INCLUDED

Ø115mm

### POW2040 ANGLE GRINDER 500W-115mm

VOLTAGE - FREQUENCY	230-240V - 50Hz
RATED POWER	500W
ROTATION SPEED	11500min <sup>-1</sup>
DISC DIAMETER	Ø115mm - M14
SPINDLE LOCK	✓



**Included:**  
1x auxiliary handle (2 pos.), 1x spanner



# Angle grinders

Ø115mm

Ø125mm

Ø230mm

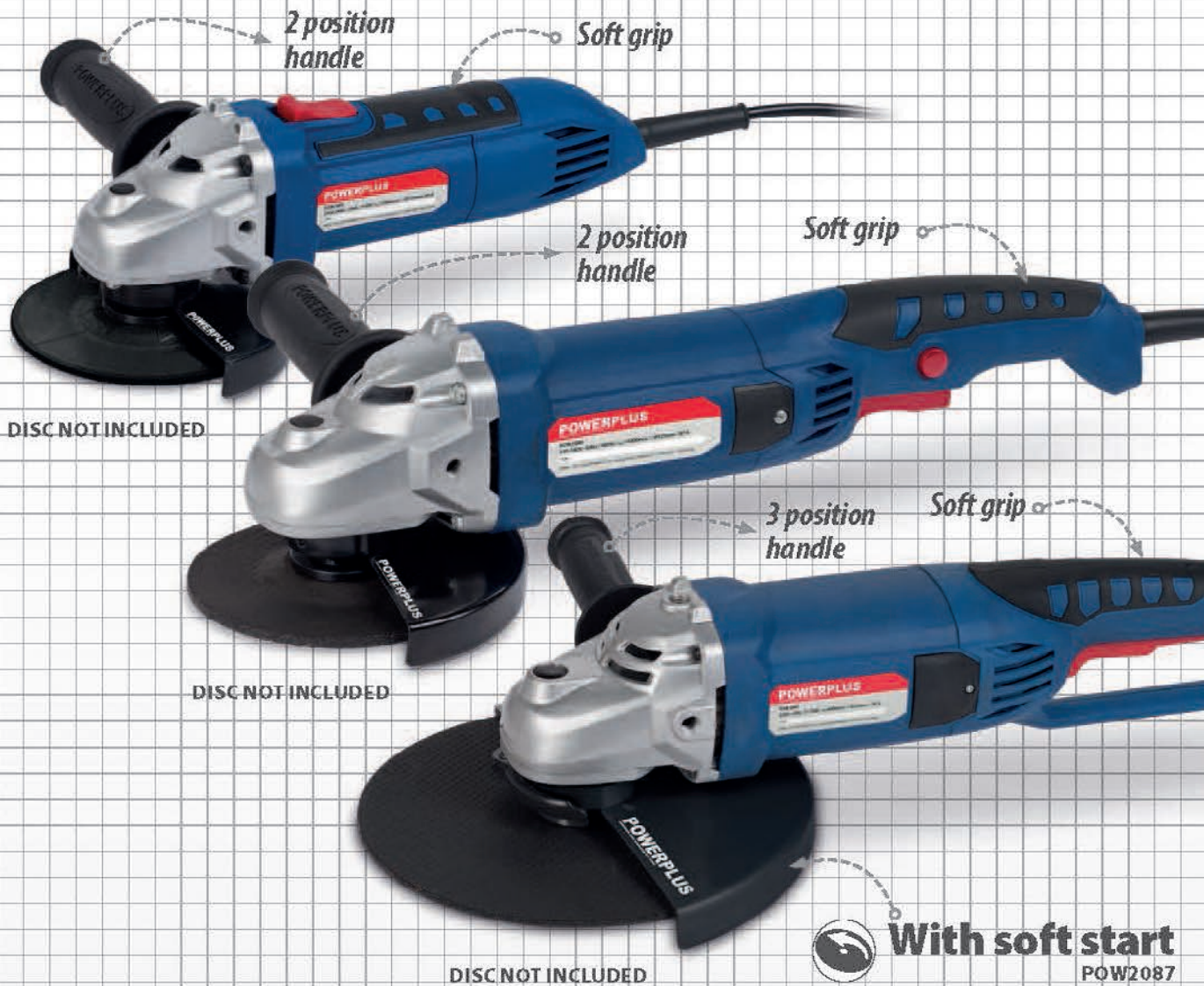

POW2085 ANGLE GRINDER  
**710W-115mm**

VOLTAGE - FREQUENCY 230-240V ~ 50Hz  
 RATED POWER 710W  
 ROTATION SPEED 12000min<sup>-1</sup>  
 DISC DIAMETER Ø115mm - M14  
 SPINDLE LOCK ✓



5 400338 057632 >

**Included:**

1x auxiliary handle (2 pos.), 1x spanner

POW2086 ANGLE GRINDER  
**900W-125mm**

VOLTAGE - FREQUENCY 220-240V ~ 50Hz  
 RATED POWER 900W  
 ROTATION SPEED 13000min<sup>-1</sup>  
 DISC DIAMETER Ø125mm - M14  
 SPINDLE LOCK ✓



5 400338 057649 >

**Included:**

1x auxiliary handle (2 pos.) 1x spanner

POW2087 ANGLE GRINDER  
**2150W-230mm**

VOLTAGE - FREQUENCY 230-240V ~ 50Hz  
 RATED POWER 2150W  
 ROTATION SPEED 6500min<sup>-1</sup>  
 DISC DIAMETER Ø230mm - M14  
 SPINDLE LOCK ✓



5 400338 057656 >

**Included:**

1x auxiliary handle (3 pos.) 1x spanner



# Bench grinders



Transparent spark screen



Work support

Left-hand guard



Dry

## POW5100 BENCH GRINDER 120W-125mm

VOLTAGE - FREQUENCY	230V ~ 50Hz
RATED POWER	120W (S2: 30min)
ROTATION SPEED	2950min <sup>-1</sup>
DRY GRINDING STONE	Ø125mm



5 400338 065132 >

**Included:**

2x spark screen, 2x work support



Transparent spark screen



Work support

Left-hand guard



Dry

## POW5101 BENCH GRINDER 150W-150mm

VOLTAGE - FREQUENCY	230V ~ 50Hz
RATED POWER	150W (S2: 30min)
ROTATION SPEED	2950min <sup>-1</sup>
DRY GRINDING STONE	Ø150mm



5 400338 065149 >

**Included:**

2x spark screen, 2x work support



# Bench grinders



Transparent spark screen



Work support

Left-hand guard

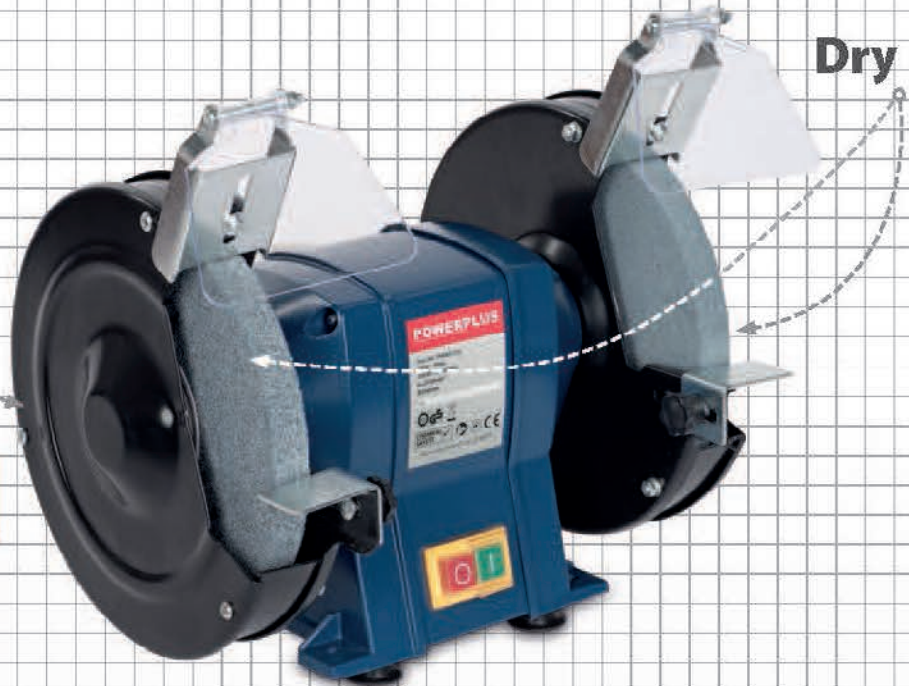

Dry

## POW5102 BENCH GRINDER 350W-200mm

VOLTAGE - FREQUENCY	230V ~ 50Hz
RATED POWER	350W
ROTATION SPEED	2950min <sup>-1</sup>
DRY GRINDING STONE	Ø200mm



5 400338 065156 >

### Included:

2x spark screen, 2x work support



Transparent spark screen



Work support

Wet & Dry



Water reservoir

## POW5103 BENCH GRINDER 250W-150/200mm

VOLTAGE - FREQUENCY	230V ~ 50Hz
RATED POWER	250W
ROTATION SPEED	2950min <sup>-1</sup>
DRY GRINDING STONE	Ø150mm
WET GRINDING STONE	Ø200mm



5 400338 065163 >

### Included:

1x spark screen, 1x work support



# Wall slotter

## QUICK OVERVIEW

- 1 ON/OFF SWITCH
- 2 SAFETY GUARD
- 3 DEPTH STOP
- 4 GUIDE HANDLE
- 5 ADJUSTABLE CUTTING DEPTH
- 6 SOFT GRIP HANDLE
- 7 DUST ADAPTOR



With  
overload  
protection

### POW222 WALL SLOTTER 1700W-150mm

VOLTAGE · FREQUENCY	230-240V~50Hz
RATED POWER	1700W
ROTATION SPEED	4000min <sup>-1</sup>
CHANNEL WIDTH	14-19-29mm
CUTTING DEPTH	10-40mm
DISC SIZE	Ø150x22.2x7mm



#### Included:

2x diamond cutting disc fixed on machine,  
1x spanner, 1x chisel, 1x dust adaptor, 1x hex key





# Sawing & Woodworking

**Jigsaws** 22  
DECOUPEERZAGEN  
SCIÉS SAUTEUSES  
STICHSÄGEN  
SIERRAS DE CALAR

**Router** 23  
BOVENFREES  
DÉFONCEUSE  
OBERFRÄSE  
FRESADORA

**Electric planer** 23  
SCHAAFmaschine  
RABOT  
ELEKTROHOBEL  
CEPILLO

**Mitre saws** 24-26  
VERSTEKZAGEN  
SCIÉS À ONGLET  
KAPP-UND GEHRUNGSSÄGEN  
INGLETADORAS

**Table saw** 27  
TAFELZAAG  
SCIE À TABLE  
TISCHKREISSÄGE  
SIERRA DE MESA

**Circular saw** 28  
CIRKELZAAG  
SCIE CIRCULAIRE  
HANDKREISSÄGE  
SIERRA CIRCULAR

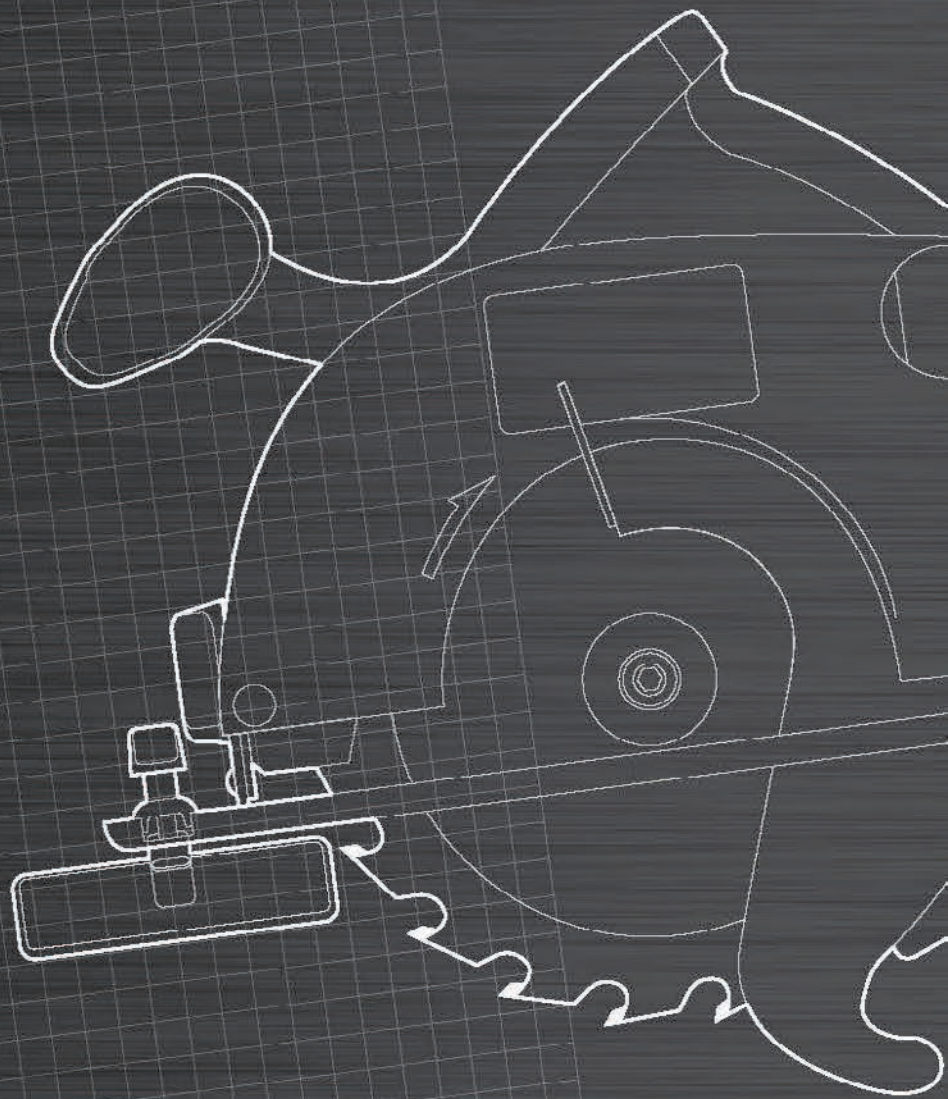

**POWERPLUS**  
DESIGNED AND MARKETED BY VARD



# Jigsaws

## POW1003 JIGSAW 350W

VOLTAGE - FREQUENCY	230-240V~ 50Hz
RATED POWER	350W
ROTATION SPEED	3000min <sup>-1</sup>
CONNECTION TYPE	T-shape
CUTTING DEPTH	WOOD 55mm STEEL 6mm



5 400338 054051 >

**Included:**  
1x saw blade (wood), 1x hex key



Adjustable base  
45°-0°-45°



Soft grip



Dust adaptor

Adjustable base  
45°-0°-45°

## POW1010 JIGSAW 450W

VOLTAGE - FREQUENCY	230V~ 50Hz
RATED POWER	450W
ROTATION SPEED	2800min <sup>-1</sup>
CONNECTION TYPE	T-shape
CUTTING DEPTH	WOOD 60mm STEEL 8mm



5 400338 057182 >

**Included:**  
1x saw blade (wood), 1x dust adaptor,  
1x hex key

Soft grip



Metal side guide

Dust adaptor

Adjustable base  
45°-0°-45°

## POW1015 JIGSAW 650W

VOLTAGE - FREQUENCY	230V~ 50Hz
RATED POWER	650W
ROTATION SPEED	0-2800min <sup>-1</sup>
CONNECTION TYPE	T-shape
CUTTING DEPTH	WOOD 80mm STEEL 10mm



5 400338 057199 >

**Included:**  
2x saw blade (wood), 1x saw blade (metal)  
1x dust adaptor, 1x side guide, 1x hex key



# Router



+ 12x router bit



## POW162X ROUTER 1020W

VOLTAGE - FREQUENCY	230-240V~ 50Hz
RATED POWER	1020W
ROTATION SPEED	11500-34000min <sup>-1</sup>
COLLET	6-8mm + 1/4"
ROUTING DEPTH	50mm



POW166 15 ROUTER BITS (p. 41)



**Included:**

1x dust extractor adaptor, 2x wrench,  
1x guide bushing, 1x profiling bar, 12x router bit

# Electric planer



## POW1520 ELECTRIC PLANER 600W

VOLTAGE - FREQUENCY	230V~ 50Hz
RATED POWER	600W
ROTATION SPEED	15000min <sup>-1</sup>
PLANER WIDTH	82mm
REBATE DEPTH	0-2mm



**Included:**

1x dust bag, 1x side guide, 1x dust adaptor,  
1x wrench, 1x hex key



# Mitre saws

## QUICK OVERVIEW

- 1 REMOVABLE BLADE GUARD
- 2 SCALE ROTARY TABLE
- 3 2x EXTENSION BAR
- 4 HANDLE

### POW8002 MITRE SAW 1400W - 210mm

VOLTAGE - FREQUENCY 230-240V~ 50Hz  
 RATED POWER 1400W  
 ROTATION SPEED 5000min<sup>-1</sup>  
 BLADE SIZE Ø210x25.4x2.8mm-24T



#### Included:

1x dust bag, 1x saw blade (mounted),  
 2x extension bar, 2x screw, 2x nut, 3x hex key



TABLE	SAW BLADE	CAPACITY (HxL)
90°	90°	50x120mm
45°	90°	50x70mm
90°	45°	30x110mm
45°	45°	30x50mm

### POW8041 MITRE SAW + UPPERTABLE 1200W - 210mm

VOLTAGE - FREQUENCY 230V~ 50Hz  
 RATED POWER 1200W  
 ROTATION SPEED 4500min<sup>-1</sup>  
 BLADE SIZE Ø210x30x2.5mm-24T  
 TABLE SIZE 380x270mm



#### Included:

1x saw blade (mounted), 1x push stick,  
 1x Allen wrench, 2x extension bar, 1x dust pipe

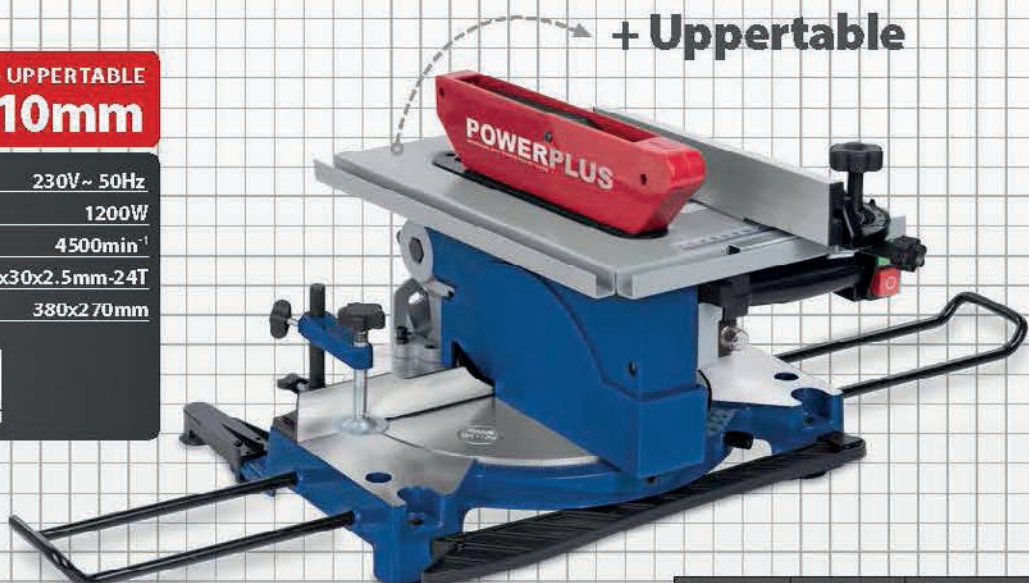
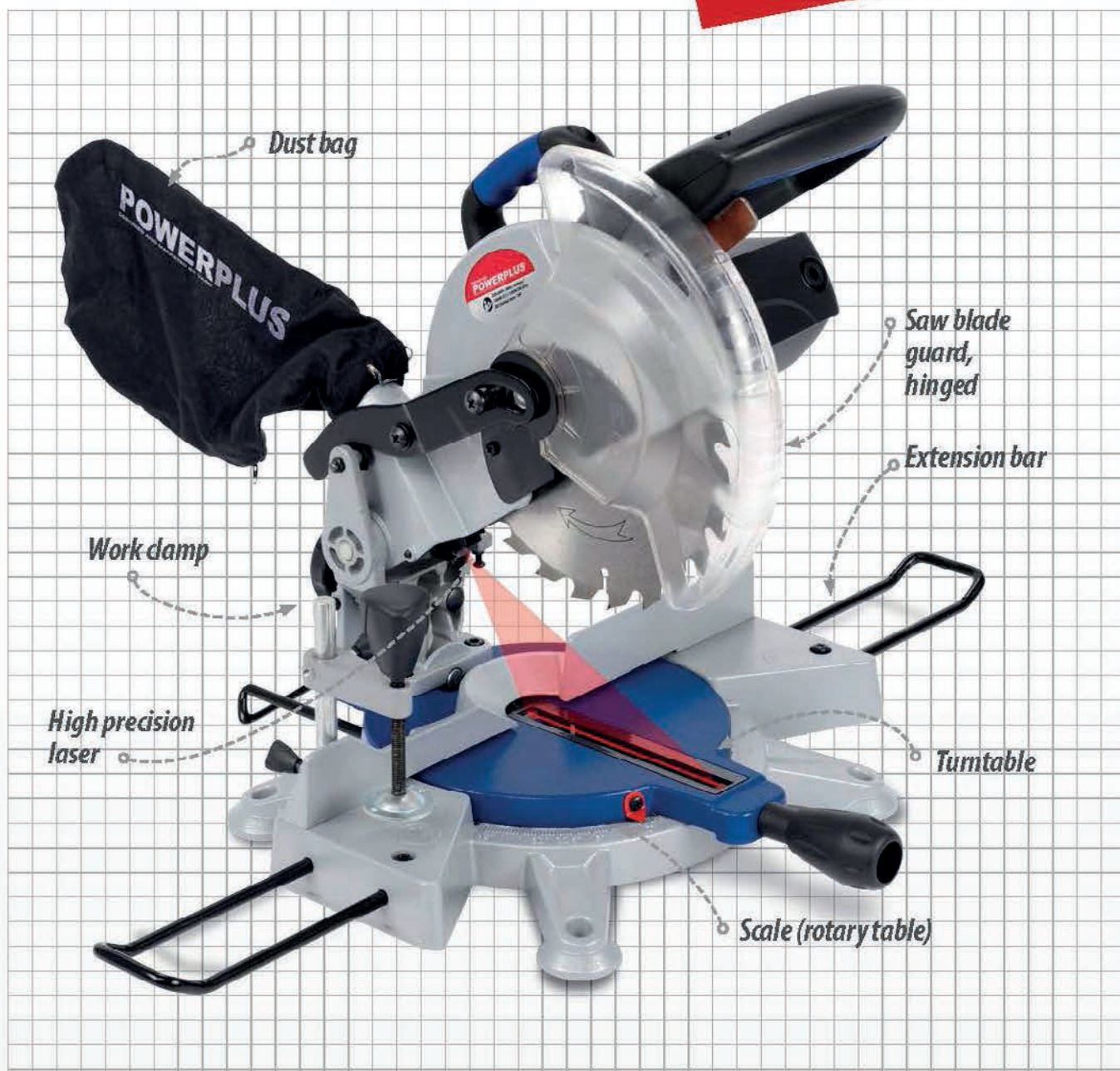

TABLE	SAW BLADE	CAPACITY (HxL)
90°	0°	55x120mm
45°	0°	55x65mm
90°	45°	35x120mm
45°	45°	23x40mm



# Mitre saws



**POW8130 MITRE SAW**  
**1500W - 210mm**

VOLTAGE - FREQUENCY 220-240V ~ 50Hz  
 RATED POWER 1500W  
 ROTATION SPEED 5000min<sup>-1</sup>  
 BLADE SIZE Ø210x30x2.6mm-24T



**Included:**  
 1x saw blade (mounted), 1x dust bag,  
 1x wrench, 3x extension bar, 1x work clamp



TABLE	SAW BLADE	CAPACITY (HxL)
90°	90°	60x120mm
45°	90°	60x80mm
90°	45°	35x120mm
45°	45°	35x80mm



# Mitre saws

## QUICK OVERVIEW

- 1 BLADE GUARD
- 2 HIGH PRECISION LASER
- 3 LOCKING HANDLE
- 4 METAL TABLE HEIGHT 76cm
- 5 3x EXTENSION BAR

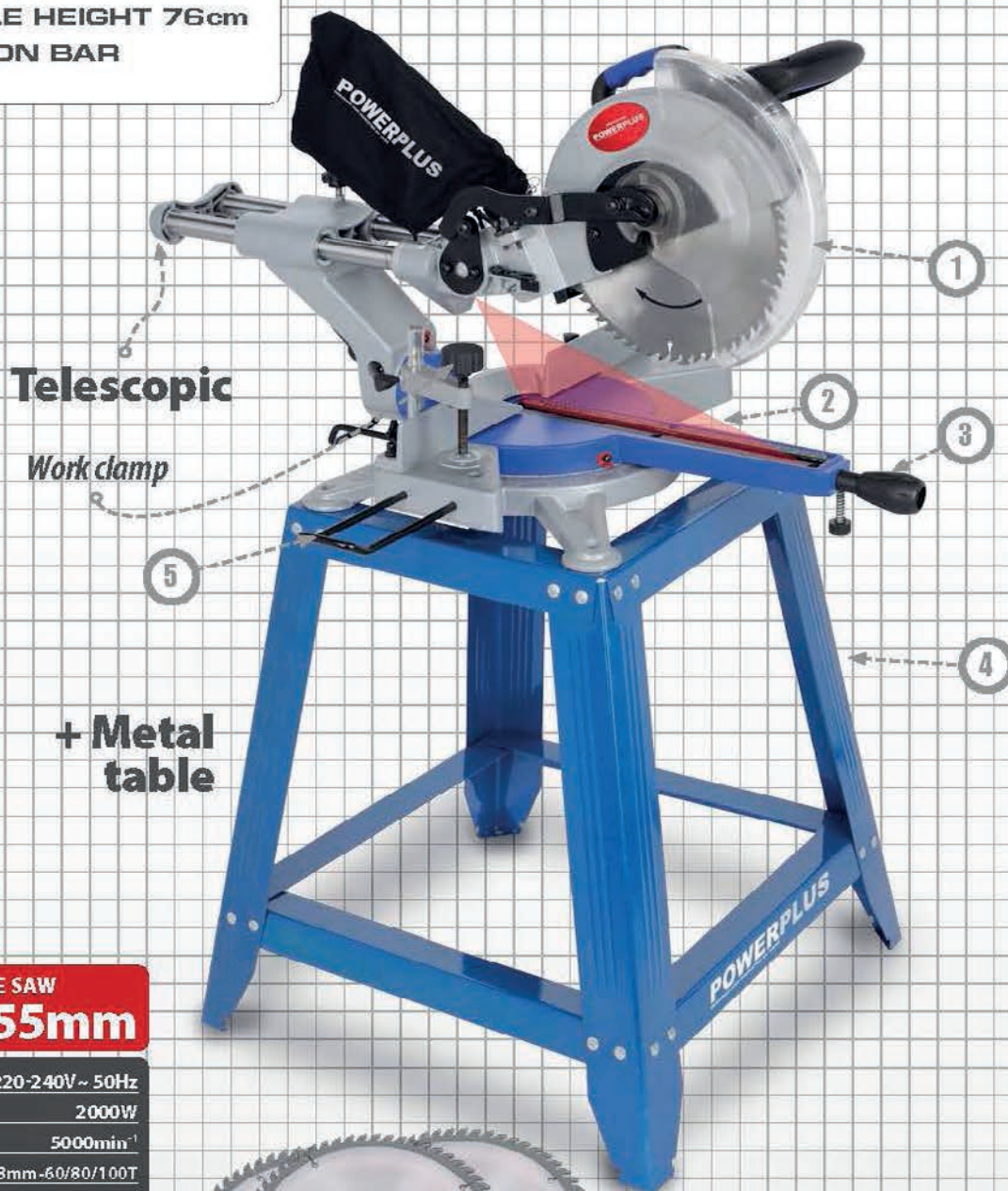

Telescopic

Work clamp

+ Metal table

### POW8136 MITRE SAW 2000W - 255mm

VOLTAGE - FREQUENCY	220-240V ~ 50Hz
RATED POWER	2000W
ROTATION SPEED	5000min <sup>-1</sup>
BLADE SIZE	255x25.4x2.8mm -60/80/100T
METAL TABLE	362x300x760mm



**Included:**  
1x table, 3x extension bar,  
1x dust bag, 1x wrench, 1x laser, 3x saw blade  
60T/80T(mounted)/100T, 1x work clamp

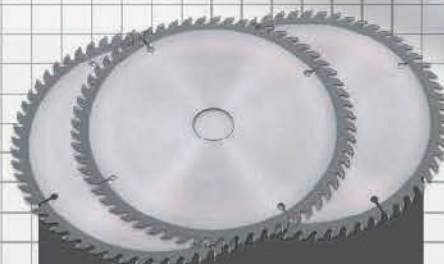

**3 SAW BLADES**  
60T / 80T / 100T

TABLE	SAW BLADE	CAPACITY (HxL)
90°	90°	70x310mm
45°	90°	42x310mm
90°	45°	70x210mm
45°	45°	42x210mm



# Table saw

## QUICK OVERVIEW

- 1 SAW BLADE HEIGHT ADJUSTMENT
- 2 MITRE ANGLE STOP
- 3 SAW BLADE ANGLE ADJUSTMENT

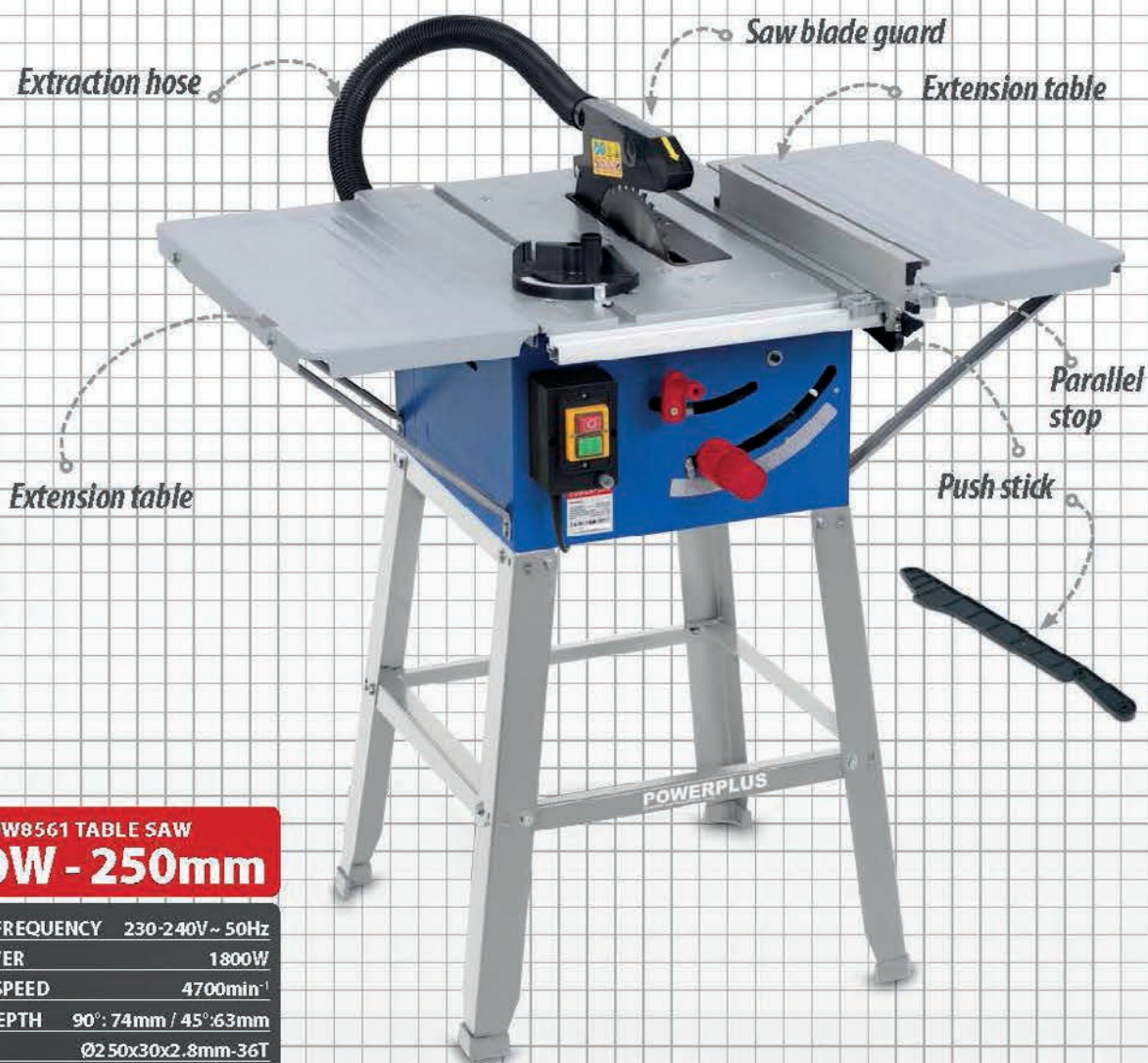

### POW8561 TABLE SAW 1500W - 250mm

VOLTAGE - FREQUENCY	230-240V ~ 50Hz
RATED POWER	1800W
ROTATION SPEED	4700min <sup>-1</sup>
CUTTING DEPTH	90°: 74mm / 45°: 63mm
BLADE SIZE	Ø250x30x2.8mm-36T
TABLE SIZE	625x432mmx86.5mm



#### Included:

1x saw blade (mounted), 2x extension table,  
1x push stick, 2x wrench, 1x extraction hose  
with connector



# Circular saw

## QUICK OVERVIEW

- 1 LEVER FOR GUARD
- 2 LOCK BUTTON FOR ANGLE ADJUSTMENT
- 3 LOCK BUTTON FOR EDGE GUIDE



### POW1044 CIRCULAR SAW **1200W - 185mm**

VOLTAGE - FREQUENCY	230-240V~ 50Hz
RATED POWER	1200W
ROTATION SPEED	5500min <sup>-1</sup>
CUTTING DEPTH	90°: 65mm / 45°: 43mm
BLADE SIZE	185x20x1.4mm-24T



**Included:**  
1x saw blade (mounted), 1x slide guide, 1x hex key



# Powerplus Specials

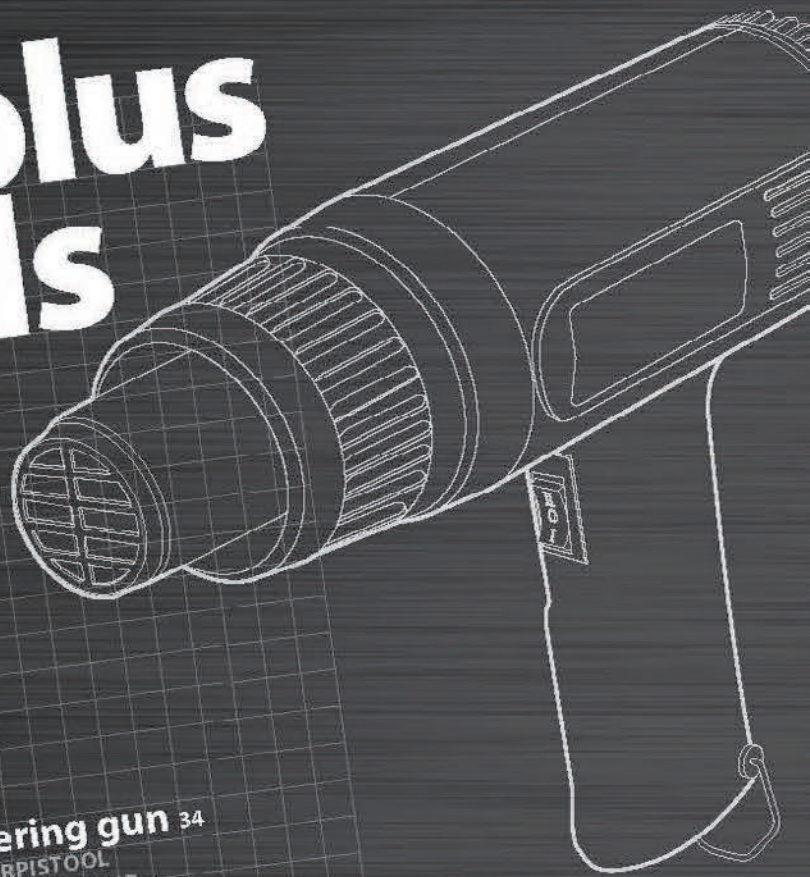

## Vacuum cleaner 30

STÖFZUIGER  
ASPIRATEUR  
STAUBSAUGER  
ASPIRADOR

## Concrete/paint mixer 30

BETON-/VERFMENGER  
MÉLANGEUR À BÉTON/PEINTURE  
RÜHRWERK  
MEZCLADOR ELÉCTRICO

## Multitool 31

MULTIGEREEDSCHAP  
OUTIL POLYVALENT  
MULTITOOL  
HERRAMIENTA MULTITOOL

## Polisher 32

POLIERMACHINE  
POLISSEUSE  
POLIERMASCHINE  
PULIDORA

## Welding machine 32

LASPOST  
POSTE À SOUDER  
SCHWEISSGERÄT  
SOLDADOR ARCO

## Heat guns 33

HETELUCHTPISTOLEN  
DÉCAPEURS  
HEIßLUFTPISTOLEN  
DECAPADORES

## Hot glue gun 34

HETELUMPISTOOL  
PISTOLET À COLLE CHAUDE  
HEIßKLEBPISTOLE  
PISTOLA DE COLA CALIENTE

## Soldering gun 34

SOLDEERPISTOOL  
PISTOLET À SOUDER  
LÖTPISTOLE  
PISTOLA DE SOLDADURA

## Nail/staple gun 34

NAGEL-/NIETAPPARAAT  
AGRAFEUSE/CLOUEUSE  
KOMBITÄCKER  
GRAPADORA/CLAVADORA

## Paint spray guns 35

VERFPISTOLEN  
PISTOLETS PULVÉRISATEURS DE PEINTURE  
FARBSPRITZPISTOLEN  
PISTOLAS PULVERIZADORAS DE PINTURA

## Hoists + pivoting arm 36-37

TAKELS & ZWENKARM  
PALANS & BRAS ORIENTABLE  
HEBEZÜGE & SCHWENKARM  
POLIPASTOS & BRAZO PIVOTANTE

## Tile cutter 38

TEGELSNIJDER  
COUPE-CARRELAGE  
FLIESENSCHNEIDMASCHINE  
CORTADOR AZULEJOS

# POWERPLUS

DESIGNED AND MARKETED BY VARD



# Vacuum cleaner

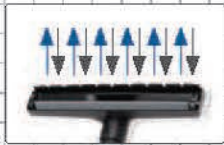

**VAC & BLOW  
FUNCTION**

**POW0343 VACUUM CLEANER  
1200W**

VOLTAGE - FREQUENCY	220-240V~ 50Hz
RATED POWER	1200W
STAINLESS STEEL TANK	20 l
SUCTION POWER	14kPa
HOSE	1.5m
CABLE	3.5m with VDE plug



5 400338 043253 >

**Included:**

1x hose 1.5m, 1x filter, 1x floor brush, 1x tube,  
1x dust filter, 1x crevice nozzle, 1x upholstery nozzle

**Wet & dry**

*Stainless steel  
20 litres*



# Mixer

**Ideal for  
concrete,  
paint,  
plaster,...**



*Electronic speed  
control  
6 positions*

Ø120mm

*Mixer spindle  
M14*



**POW1905 MIXER  
1200W**

VOLTAGE - FREQUENCY	220-240V~ 50Hz
RATED POWER	1200W
ROTATION SPEED	0-700min <sup>-1</sup>
LENGTH MIXING PADDLE	600mm
DIAMETER MIXING PADDLE	Ø120mm



5 400338 051494 >

**Included:**

1x mixer bar (adaptor), 1x mixing paddle,  
2x wrench



# Multitool + accessories

**40 accessories multitool**

**POW1820 MULTITOOL  
135W**

VOLTAGE - FREQUENCY	230V ~ 50Hz
RATED POWER	135W
ROTATION SPEED	8000-32500min <sup>-1</sup>
COLLET SIZE	2.3 - 3.2mm

5 400338 029028 >

**BMC INCLUDED**

**Included:**  
1x set stand & clamp, 1x flexible pipe,  
40 accessories: grinding stones/discs/drills

**POW18205 ACCESSORIES FOR MULTITOOL  
102 ACCESSORIES**

**Included**

- Sanding band: 11x 1/2" x 1/2" & 11x 1/4" x 1/2"
- 1x drum sander with 1/8" shank for 1/2" x 1/2" sanding band
- 1x drum sander with 1/8" shank for 1/4" x 1/2" sanding band
- 1x sanding disc wheel 1/8"
- 1x screw mandrel for felt polishing accessories
- 1x collet
- 1x polishing compound
- 1x dressing stone
- 10x 1-1/4" fiberglass reinforced cut-off wheel accessories
- 10x felt polishing wheel: 5x 1" & 5x 1/2"
- 5x felt polishing tip
- 25x cut-off wheel
- 11x grinding stone: 8x 1/8" shank & 3x 1/10" shank
- 6x HSS rotary files & rasp
- 3x nylon brush 1/8" shank
- 3x copper brush 1/8" shank

**Grinding Stones & Points**

**Rotary Files & Rasp**

**Sanding Wheels & Wire Brushes**

5 400338 029363 >

**BMC INCLUDED**



# Polisher



Coarse polishing cover

Fine polishing cover



## POW404 POLISHER 110W - 240mm

VOLTAGE - FREQUENCY	220-240V ~ 50Hz
RATED POWER	110W
ROTATION SPEED	3100min <sup>-1</sup>
DISC DIAMETER	Ø240mm



5 400338 014727 >

**Included:**

1x fine polishing cover, 1x coarse polishing cover

# Welding machine

Overheat indicator



Electrode clamp

Earth clamp

## POW462 WELDING MACHINE 160A

VOLTAGE - FREQUENCY	230V ~ 50Hz
INPUT CAPACITY	8kW
OUTPUT CURRENT	160A
ELECTRODE CAPACITY	2-4mm



5 400338 020810 >

**Included:**

1x welding mask, 1x steel brush/welding hammer

Protective welding mask

Steel brush/  
Welding hammer



# Heat guns



## POW703 HEAT GUN 1600W

VOLTAGE - FREQUENCY 230V ~ 50Hz  
RATED POWER I: 1000W / II: 1600W  
AIR TEMPERATURE/FLOW I: 380°C - 300 l/min  
II: 500°C - 500 l/min



**Included:**  
4x nozzle, 1x set of scrapers



## POW706 HEAT GUN 2000W

VOLTAGE - FREQUENCY 230V ~ 50Hz  
RATED POWER I: 1350W / II: 2000W  
AIR TEMPERATURE/FLOW I: 300°C - 300 l/min  
II: 600°C - 500 l/min



**Included:**  
4x nozzle



Hot glue gun  
Soldering gun  
Nail/staple gun

POW721 HOT GLUE GUN

**78W**

VOLTAGE - FREQUENCY 220-240V~ 50Hz  
RATED POWER 78W  
GLUING CAPACITY 8-12g/min  
GLUE STICK Ø11x100mm



**Included:**  
2x glue stick 11mm

POW726 SOLDERING GUN

**175W**

VOLTAGE - FREQUENCY 220-240V~ 50Hz  
RATED POWER 175W  
INTERMITTENT SERVICE 12s/48s



**Included:**

(1) 2x soldering tip, (1) 1x cutting tip,  
(2) 1x soldering reel, (3) 1x flux

POW737 NAIL/STAPLE GUN

VOLTAGE - FREQUENCY 230V~ 50Hz  
FIRING CAPACITY 20strokes/min  
STAPLE WIDTH 11.2mm  
NAIL SIZE 15mm  
STAPLE SIZE 8>16mm



**+ 200 staples / 100 nails**



# Paint spray guns



Viscosity cup

Flexible nozzle extension

Spray basket nozzle

Output control

Trigger switch

**POW751 PAINT SPRAY GUN**  
**100W**

VOLTAGE - FREQUENCY	230V~ 50Hz
RATED POWER	100W
FLOW SPEED	280g/min
NOZZLE DIAMETER	0.6 / 0.8 / 1mm
TANK CAPACITY	900ml

5 400338 031403 >

**Included:**  
1x cleaning brush, 1x viscosity cup,  
1x spare valve, 1x flexible nozzle extension,  
3x spray basket nozzle (1 mounted)



Viscosity cup

Compressor unit

Flexible air hose

Spray nozzle

Carrying belt

**POW754 PAINT SPRAY GUN**  
**600W**

VOLTAGE - FREQUENCY	230-240V~ 50Hz
RATED POWER	600W
FLOW SPEED	380g/min
NOZZLE DIAMETER	Ø1.8mm
TANK CAPACITY	800ml

5 400338 032134 >

**Included:**  
1x funnel, 1x spray gun storage tray,  
1x flexible air hose 1.5m, 1x carrying belt



# Hoists

## ➔ QUICK OVERVIEW

- 1 CABLE LENGHT 12.5m
- 2 MOTOR HOUSING
- 3 CONTROL BOX
- 4 FIXATION CLAMPS
- 5 LOAD HOOK
- 6 LOAD & PULLY HOOK



**POW900 HOIST**  
**500W**

VOLTAGE - FREQUENCY	230V ~ 50Hz
RATED POWER	500W
LIFTING SPEED	single load 8m/min double load 4m/min
MAX. CAPACITY	single load 100kg double load 200kg
LIFTING HEIGHT	single load 12m double load 6m



**POW901 HOIST**  
**1000W**

VOLTAGE - FREQUENCY	230V ~ 50Hz
RATED POWER	1000W
LIFTING SPEED	single load 8m/min double load 4m/min
MAX. CAPACITY	single load 200kg double load 400kg
LIFTING HEIGHT	single load 12m double load 6m





# Hoists + pivoting arm

## POW910 PIVOTING ARM FOR HOIST

MAX. LOAD	at 750mm 600kg
	at 1100mm 300kg
LENGTH OF SUPPORT	750mm
LENGTH OF EXTENDED SUPPORT	1100mm



Rotation 50° left  
Rotation 50° right



## POW902 HOIST 1050W

VOLTAGE - FREQUENCY	230V~ 50Hz
RATED POWER	1050W
LIFTING SPEED	single load 8m/min double load 4m/min
MAX. CAPACITY	single load 300kg double load 600kg
LIFTING HEIGHT	single load 12m double load 6m



## POW903 HOIST 1300W

VOLTAGE - FREQUENCY	230V~ 50Hz
RATED POWER	1300W
LIFTING SPEED	single load 9m/min double load 4,5m/min
MAX. CAPACITY	single load 400kg double load 800kg
LIFTING HEIGHT	single load 12m double load 6m





# Tile cutter

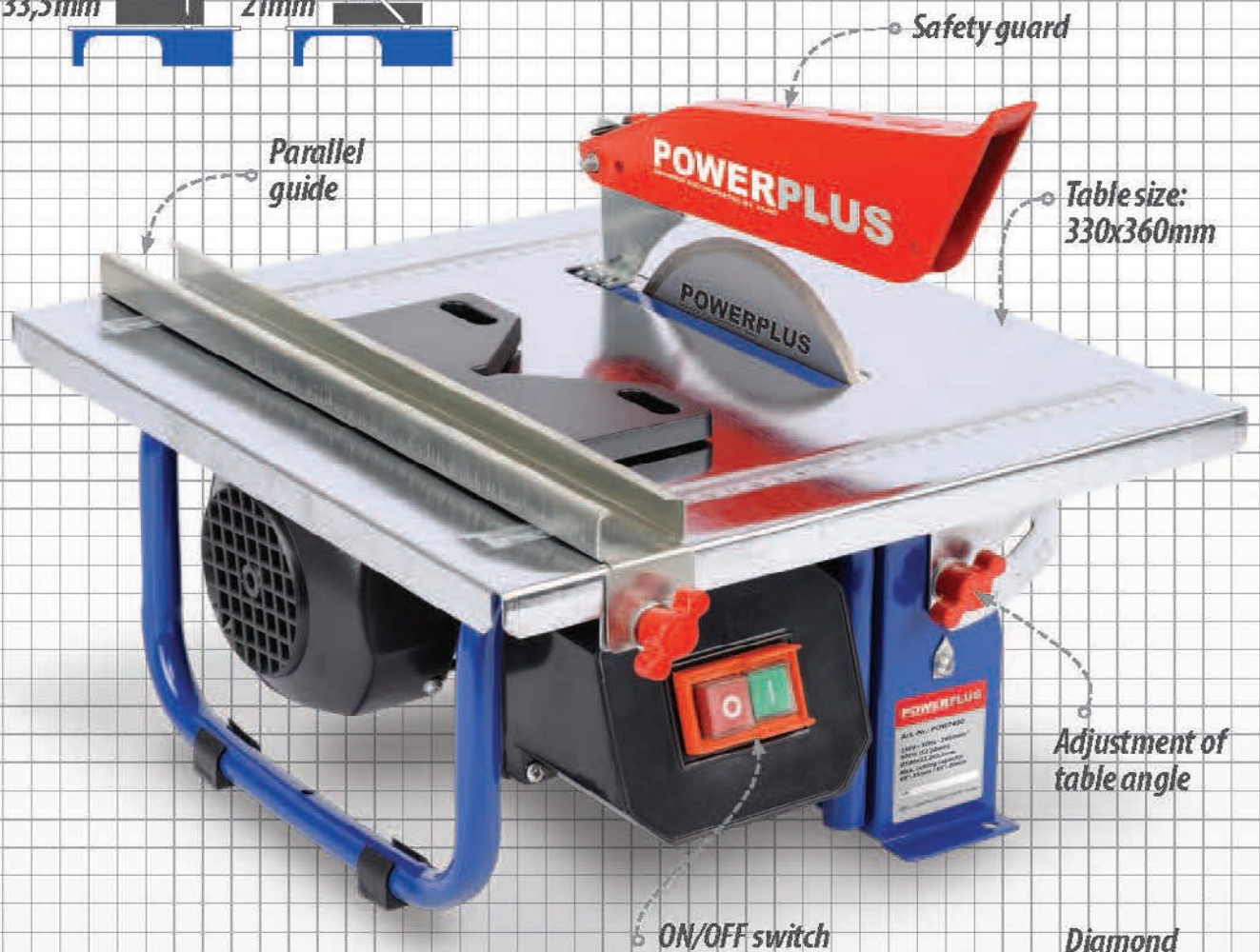
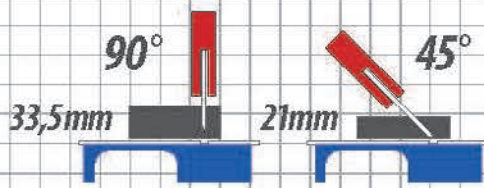

+ PRCD plug



## POW7490 TILE CUTTER 600W - 180mm

VOLTAGE - FREQUENCY	230V - 50Hz
RATED POWER	600W
ROTATION SPEED	2950min <sup>-1</sup>
BLADE SIZE	Ø180x22.2x2.2mm
CUTTING CAPACITY	90°: 33,5mm / 45°: 21mm
TABLE SIZE	330x360mm



**Included:**  
1x diamond blade, 1x water tray  
1x parallel guide, 1x guard



# Powerplus Generators

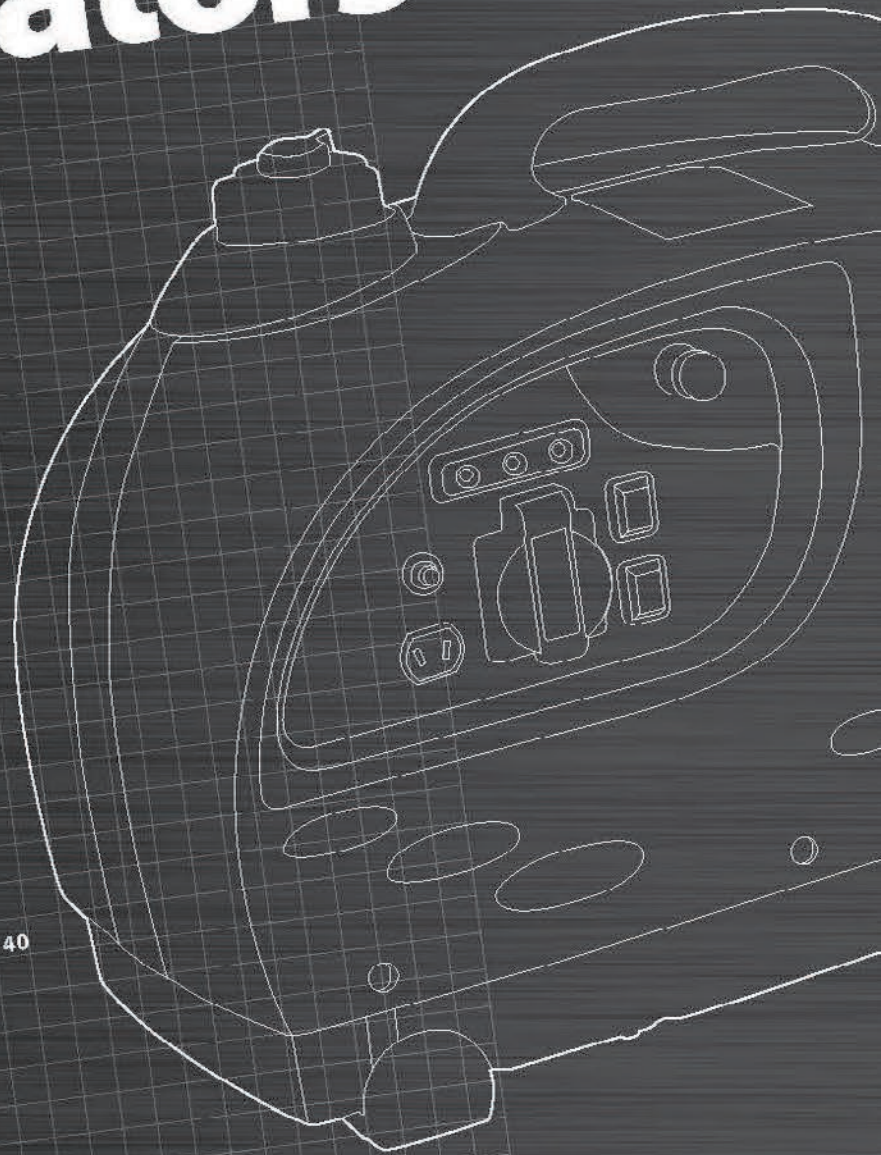

## Power station 4-IN-1 40

ENERGIESTATION  
ALIMENTATION ÉLECTRIQUE  
SCHNELLSTARTSYSTEM  
ARRANCADOR

## Power generator 40

GENERATOR  
GROUPE ÉLECTROGÈNE  
STROMERZEUGER  
GENERADOR

**POWERPLUS**  
DESIGNED AND MARKETED BY VARD



## Power station 4-IN-1

**Battery booster:** starting energy 400A, peak up to 900A. 12 Volt battery, 1700mAh. Can start petrol engines up to 3000cc and diesel engines up to 2200cc. Compressor with pressure gauge 250psi. Supplied with hose and 3 adaptors of which one connected with hose. Handy for inflating footballs, air mattresses, tyres,...

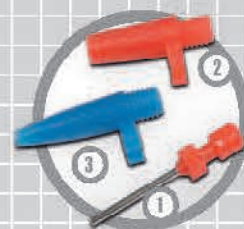

POW5633 POWER STATION 4-IN-1

**900A**

OUTPUT CURRENT	900A
BOOST CLAMPS	400Amp heavy duty
BATTERY POWER	12V - 6A max
AIR COMPRESSOR	250psi



**Included:**

220V charger, connection cable with 12V cigarette lighter adaptor, 1 charging cables with fully insulated pole clips, 3 adaptors: (1) ball adaptor / (2) tire valve adaptor / (3) air mattress adaptor



Light 3.6W



## Power generator



TANK 4.2L  
UNLEADED  
FUEL

POW470 POWER GENERATOR

**720W**

VOLTAGE - FREQUENCY	230V ~ 50Hz
RATED POWER	650W - 720W (S2: 15min)
ROTATION SPEED	3000min <sup>-1</sup>
ENGINE TYPE	2HP / 2-STROKE / AIR COOLED
CONTINUOUS OPERATING	5.8h
TANK CAPACITY	4.2l













**Included:**

1x spark plug wrench



With  
overload  
protection



MODEL	DESCRIPTION	PIC.	BARCODE	MODEL	DESCRIPTION	PIC.	BARCODE
POW166	<b>15 ROUTER BITS</b> Ø8mm + BMC		5 400338 021725 >	POW735N12	<b>NAILS 2000 pcs</b> 12mm FIT POW736		5 400338 020261 >
POW30580CF	<b>FLAT CHISEL</b> SIZE: 410mmxØ30mm		5 400338 028847 >	POW735N16	<b>NAILS 2000 pcs</b> 16mm FIT POW736		5 400338 020278 >
POW30580CP	<b>POINTED CHISEL</b> SIZE: 410mmxØ30mm		5 400338 028854 >	POW735S12	<b>STAPLES 1000 pcs</b> 12mm FIT POW736		5 400338 020247 >
POW0340A	<b>DUST BAGS 30L</b> 5 pcs FIT POW0348		5 400338 028274 >	POW735S16	<b>STAPLES 1000 pcs</b> 16mm FIT POW736		5 400338 020254 >
POW0341A	<b>DUST BAGS 10L</b> 5 pcs FIT POW0343		5 400338 028373 >	POW18205	<b>102 MULTITOOL ACCESSORIES</b> FIT POW1820		5 400338 029363 >
POW0345A	<b>DUST BAGS 15L</b> 5 pcs FIT POW0345		5 400338 030390 >				



For more accessories  
check out our Kreator range  
on [www.kreator.be](http://www.kreator.be)

## KREATOR





5 400338 065309 >

**varo**

**VIC. VAN ROMPUY nv**

JOSEPH VAN INSTRAAT 9  
2500 LIER - BELGIUM  
TEL +32 (0)3 292.92.92  
FAX +32 (0)3 292.92.72  
E-MAIL: INFO@VARO.COM  
WWW.VARO.COM

**OFFICES:**

IBERICA BRICOLAGE S.L. - ESPAÑA  
ASIA PACIFIC HONG KONG Ltd / SHANGHAI PRC  
AUSTRALIA Pty Ltd / GERMANY GmbH

**POWERPLUS** **2 YEAR WARRANTY**  
DESIGNED AND MANUFACTURED BY VARO

© Copyright VARO - Vic. Van Rompuuy nv 2014 / Product specifications are subject to change without notice. VARO is not responsible for typographical or photographic errors that may appear in this catalogue. Pictures may vary from the actual products. We reserve the right to make adjustments or corrections due to errors, changing market conditions, product discontinuations, or typographic or photographic errors in advertisements or product descriptions. Item availability and prices are subject to change without notice.

SDS® is a registered trademark of Robert Bosch GmbH / Torx® is a registered trademark of Acument Intellectual Properties, LLC.