

**3 YEAR
WARRANTY**

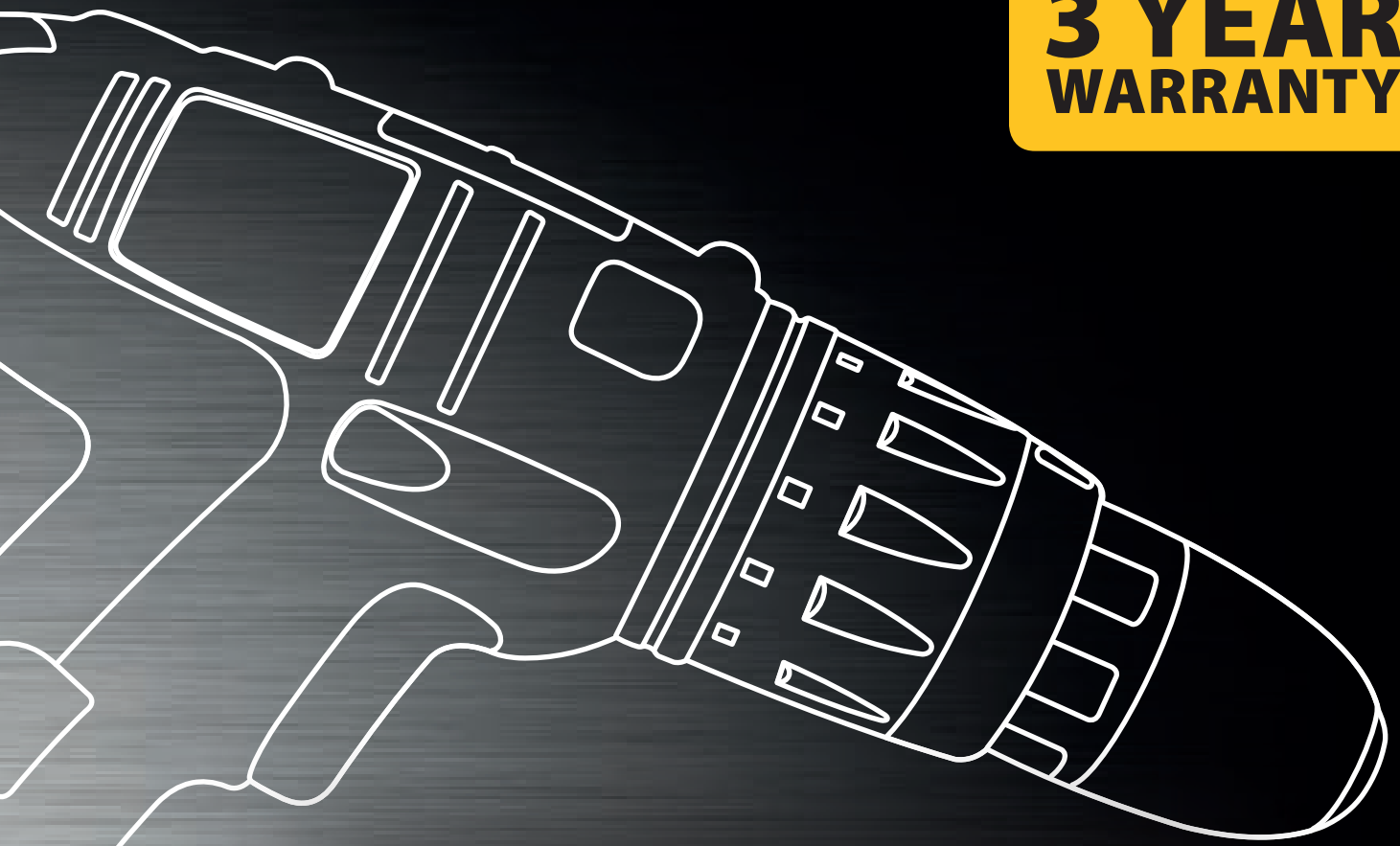

POWERPLUS[®]
HIGH QUALITY TOOLS

POWERPLUS®

HIGH QUALITY TOOLS



Index

One fits all

POWX0070LI	LI-ION DRILL/SCREWDRIVER	18V	P 5
POWX0073LI	LI-ION IMPACT SCREWDRIVER	18V	P 6
POWX0074LI	LI-ION IMPACT WRENCH	18V	P 7
POWX0075LI	LI-ION JIGSAW	18V	P 8
POWX0076LI	LI-ION CIRCULAR SAW	18V	P 9
POWX0077LI	LI-ION RECIPROCATING SAW	18V	P 10
POWX0079LI	LI-ION ANGLE GRINDER	18V	P 11

Drilling

POWX0052	DRILL/SCREWDRIVER	14.4V	P 13
POWX0055	DRILL/SCREWDRIVER	18V	P 13
POWX0057	DRILL/SCREWDRIVER	18V	P 14
POWX0060LI	LI-ION SCREWDRIVER	3.6V	P 15
POWX0062LI	LI-ION DRILL/SCREWDRIVER	12V	P 15
POWX0065LI	LI-ION DRILL/SCREWDRIVER	14.4V	P 15
POWX0068LI	LI-ION DRILL/SCREWDRIVER	18V	P 15
POWX026	IMPACT DRILL	710W	P 16
POWX027	IMPACT DRILL	910W	P 16
POWX028	IMPACT DRILL	1200W	P 17
POWX112	HAMMER DRILL	1050W	P 18
POWX1152	HAMMER DRILL	1250W	P 19
POWX1155	HAMMER DRILL	1600W	P 19
POWX152	BENCH DRILL	350W	P 20
POWX154	BENCH DRILL	500W	P 20



Sanding, Polishing & Grinding

POWX0400	FINISHING SANDER	220W	P 22
POWX0440	FINISHING SANDER	330W	P 22
POWX0460	BELT SANDER	950W	P 23
POWX139	FILE BELT SANDER	400W	P 24
POWX0470	ROTATING SANDER	450W	P 25
POWX0480	PALM SANDER	220W	P 26
POWX0490	TRIANGULAR SANDER	300W	P 27
POWX0474	ANGLE POLISHER	1200W	P 28
POWX0476	DRYWALL SANDER	710W	P 29
POWX0478	WALL/CEILING SANDER	1220W	P 30
POWX0610	ANGLE GRINDER	900W	P 31
POWX0613	ANGLE GRINDER	1200W	P 31
POWX0617	ANGLE GRINDER	2500W	P 31
POWX0650	WALL SLOTTER	1800W	P 32
POWX1230	BENCH GRINDER DRY	350W	P 33
POWX1250	BENCH GRINDER WET & DRY	350W	P 33
POWX1340	MULTITOOl	180W	P 34
POWX1345	MULTI-USE TOOL	300W	P 35
POWX1350	MULTI-USE SHARPENER	96W	P 36



Sawing

POWX0330	JIGSAW	650W	P 38
POWX0360	JIGSAW	810W	P 38
POWX0396	RECIPROCATING SAW	720W	P 39
POWX0520	CIRCULAR SAW	1500W	P 40
POWX0550	CIRCULAR SAW	1800W	P 40
POWX0561	PLUNGE SAW	1200W	P 41
POWX1365MB	MINI CIRCULAR SAW	600W	P 42
POWX0680	DUAL SAW	1050W	P 43
POWX0682	DUAL SAW / DESTROYER	1500W	P 43
POWX070	MITRE SAW	1800W	P 44
POWX075	TELESCOPIC MITRE SAW	2000W	P 45
POWX077	TELESCOPIC MITRE SAW	1600W	P 46
POWX0700T	ROLLER SUPPORT STAND		P 47
POWX0782	MITRE SAW WITH UPPERTABLE	1800W	P 48
POWX0760	MITRE / TABLE SAW - FLIPOVER	1800W	P 49
POWX221	TABLE SAW	1500W	P 50
POWX180	BAND SAW	350W	P 51
POWX190	SCROLL SAW	85W	P 52
POWX230	TILE CUTTER	750W	P 53
POWX240	TILE CUTTER	600W	P 53
POWX242	TILE CUTTER	1100W	P 53

Woodworking

POWX1110	PLANER	900W	P 55
POWX200	THICKNESS PLANER	1800W	P 56
POWX204	JOINTER PLANER	1500W	P 57
POWX0910	ROUTER	1200W	P 58
POWX093	ROUTER	1500W	P 58
POWX131	BISCUIT JOINTER	900W	P 59



Specials

Power stations

POWX410	PORTABLE 4-IN-1 POWER STATION	12V	P 61
POWX510	POWER GENERATOR	2200W	P 62
POWX513	POWER GENERATOR	3000W	P 62
POWX516	POWER GENERATOR	5500W	P 62

Cleaners

POWX320	VACUUM CLEANER	800W	P 63
POWX321	VACUUM CLEANER	1000W	P 63
POWX323	VACUUM CLEANER	1200W	P 64
POWX325	VACUUM CLEANER (2x ENGINE)	2x 1200W	P 65
POWX302	ASH CLEANER		P 66
POWX305	ASH CLEANER	1000W	P 66
POWX308	ASH/VACUUM CLEANER	1200W	P 66

Deco

POWX1020	HEAT GUN	2000W	P 67
POWX350	PAINT SPRAY GUN	120W	P 68
POWX353	PAINT SPRAY GUN	400W	P 68
POWX355	PAINT SPRAY STATION	350W	P 69
POWX357	PAINT SPRAY STATION	900W	P 69
POWX340	WALLPAPER STRIPPER	2200W	P 70

Various

POWX083	CONCRETE/PAINT MIXER	1220W	P 72
POWX084	CONCRETE/PAINT MIXER	1600W	P 72
POWX088	DOUBLE MIXER	1600W	P 73
POWX145	HOT GLUE GUN	35W	P 74
POWX1380	SOLDERING IRON	30W	P 75
POWX1381	SOLDERING IRON	60W	P 75
POWX1385	SOLDERING GUN	100W	P 75
POWX137	NAIL/STAPLE GUN	4.8V	P 76
POWX138	NAIL/STAPLE GUN		P 77
POWX720	SELF-LEVELLING LASER LEVEL		P 78

ONE FITS ALL 18V



POWERED BY **HIGHTAR**®



LITHIUM-ION

- + **no** self discharge + **no** memory effect
- + **more** energy and **better** performance
- + **environmentally friendly**

LI-ION one fits all POWX0070LI Drill/screwdriver

SCHROEFBOORMACHINE // PERCEUSE/VISSEUSE // BOHRRSCHRAUBER // TALADRO/ATORNILLADOR



POWERPLUS
HIGH QUALITY TOOLS

18V
**ONE
FITS ALL**
HIGH STAR



POWX0070LI 18V LI-ION + BMC

Battery capacity	1500mAh Li-Ion
Charging time	1 hour
Rotation speed	0-400 / 0-1200min ⁻¹
Maximum torque	28Nm
Chuck	Ø 13mm keyless sanou chuck + lock
Left/right	Yes

- Features
- LED worklight
 - 23 + 1 torque positions
 - Forward/reverse knob
 - Soft touch
 - Soft grip
 - Wrist strap
 - Quick stop

- Included
- 1x quick charger
 - 1x 1500mAh Li-Ion battery
 - 1x double-head screw bit
 - 1x BMC

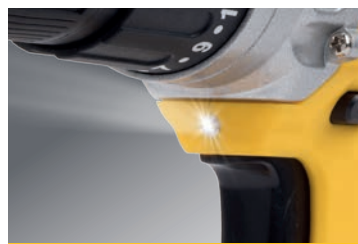

LED WORKLIGHT



13mm KEYLESS SANOU
CHUCK + LOCK

EXTRA BATTERY

POWX0095LI - 18V - LI-ION

Fits: POWX0070LI / POWX0073LI
POWX0074LI / POWX0075LI
POWX0076LI / POWX0077LI
POWX0079LI



18V LI-ION
BATTERY 1500mAh
HIGH STAR

1h QUICK CHARGER



LI-ION one fits all POWX0073LI Impact screwdriver



SLAGSCHROEVENDRAAIER // TOURNEVIS À PERCUSSION // SCHLAGSCHRAUBER // ATORNILLADOR DE IMPACTO

18V
ONE FITS ALL
HIGH STAR

HEX-SHAPED SOCKET



LED WORKLIGHT

SOFT GRIP

FORWARD/REVERSE KNOB

WRIST STRAP

DOUBLE-HEAD SCREW BIT

INCLUDED:

- 1x DOUBLE-HEAD SCREW BIT
- 6x 25mm BIT (PH1/2/3 & PZ1/2/3)
- 1x ADAPTOR WITH MAGNETIC BIT HOLDER
- 3x SOCKET (8/10/13mm)
- 1x ADAPTOR HEX TO SOCKET (1/4")



POWX0073LI
18V Li-Ion + BMC

Battery capacity	1500mAh Li-Ion
Charging time	1 hour
Rotation speed	0-2300min ⁻¹
Maximum torque	80Nm
Chuck	HEX shaped socket
Left/right	Yes
Features	<ul style="list-style-type: none"> • LED worklight • Forward/reverse knob • Soft touch • Soft grip • Wrist strap
Included	<ul style="list-style-type: none"> • 1x quick charger • 1x 1500mAh Li-Ion battery • 3x sockets (8/10/13mm) • 1x adaptor hex to socket • 6x 25mm bits (PH1/PH2/PH3 & PZ1/PZ2/PZ3) • 1x double-head screw bit • 1x magnetic bit holder • 1x BMC



18V LI-ION BATTERY 1500mAh
HIGH STAR
1h QUICK CHARGER



LI-ION one fits all POWX0074LI Impact wrench

SLAGMOERSLEUTEL // CLÉ A CHOC // SCHLAGSCHRAUBER // LLAVE DE IMPACTO



POWERPLUS
HIGH QUALITY TOOLS

18V
**ONE
FITS ALL**
HIGH STAR



POWX0074LI
18V Li-Ion + BMC

Battery capacity	1500mAh Li-Ion
Charging time	1 hour
Rotation speed	0-2200min ⁻¹
Maximum torque	310Nm
Impact rate	0-3000 impacts per minute
Left/right	Yes
Features	<ul style="list-style-type: none"> • LED worklight • Forward/reverse knob • Soft touch • Soft grip • Wrist strap
Included	<ul style="list-style-type: none"> • 1x quick charger • 1x 1500mAh Li-Ion battery • 1x BMC



LED WORKLIGHT



SOCKET TYPE 1/2"



ANVIL

**18V LI-ION
BATTERY 1500mAh**
HIGH STAR
1h QUICK CHARGER



LI-ION one fits all POWX0075LI Jigsaw

DECOUPEERZAAG // SCIE SAUTEUSE // STICHSÄGE // SIERRA DE CALAR



18V
**ONE
FITS ALL**
HIGH STAR

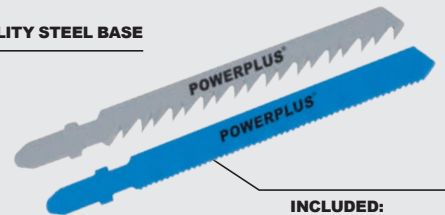

**INCLUDED:
BLADE FOR WOOD
BLADE FOR METAL**



POWX0075LI
18V Li-Ion + BMC

Battery capacity	1500mAh Li-Ion
Charging time	1 hour
Rotation speed	0-2400min ⁻¹
Cutting depth	Wood: 65mm Plastic: 20mm Steel: 8mm
Adjustable base	45° left/ right
Pendular	4 positions
Features	<ul style="list-style-type: none"> • LED worklight • Quick release blade clamp • Lock button • Soft touch • Soft grip
Included	<ul style="list-style-type: none"> • 1x quick charger • 1x 1500mAh Li-Ion battery • 1x blade for wood • 1x blade for metal • 1x BMC

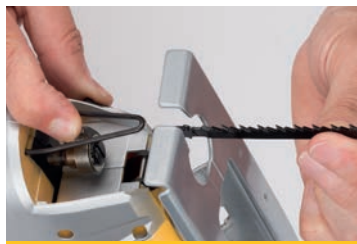

**QUICK RELEASE BLADE CLAMP
+ 2 EXTRA BLADES**



**ADJUSTABLE BASE
45° LEFT / RIGHT**



**SELECTOR SWITCH FOR
PENDULUM ACTION - 4 POSITIONS**

**18V LI-ION
BATTERY 1500mAh
HIGH STAR®
1h QUICK CHARGER**



LI-ION one fits all POWX0076LI Circular saw

CIRKELZAAG // SCIE CIRCULAIRE // HANDKREISSÄGE // SIERRA CIRCULAR



POWERPLUS
HIGH QUALITY TOOLS



18V
**ONE
FITS ALL**
HIGH STAR



POWX0076LI
18V Li-Ion + BMC

Battery capacity	1500mAh Li-Ion
Charging time	1 hour
Rotation speed	4000min ⁻¹
Blade dimensions	Ø 165x20x2.4mm
Cutting depth	90° : 52mm 45° : 36mm
Features	<ul style="list-style-type: none"> • Laser • Scale for mitre angle • Scale for saw blade depth • Lock button • Steel base • Soft touch • Soft grip
Included	<ul style="list-style-type: none"> • 1x quick charger • 1x 1500mAh Li-Ion battery • 1x saw blade • 1x metal side guide • 1x BMC



Ø165x20x2.4mm - TCT BLADE - 18T
MAX. CUTTING CAPACITY:
52mm (90°) / 36mm (45°)



SCALE FOR MITRE ANGLE & LOCK LEVER FOR ANGLE ADJUSTMENT
STEEL BASE 0-45° INCLINABLE



SCALE FOR SAW BLADE DEPTH & ADJUSTING SCREW FOR DEPTH OF CUT

18V LI-ION BATTERY 1500mAh
HIGH STAR
1h QUICK CHARGER



LI-ION one fits all POWX0077LI Reciprocating saw





RECIPROZAAG // SCIE SABRE // SÄBELSÄGE // SIERRA DE ESPADA

18V
**ONE
FITS ALL**
HIGH STAR



INCLUDED:
BLADE FOR WOOD
BLADE FOR METAL

 POWX0077LI 18V Li-Ion + BMC	
Battery capacity	1500mAh Li-Ion
Charging time	1 hour
Rotation speed	0-3000min ⁻¹
Blade stroke length	18mm
Cutting depth	Wood : 65mm Steel : 6mm
Features	<ul style="list-style-type: none"> • Fast toolless blade change • Adjustable & pivoting shoe • Lock button • Soft touch • Soft grip • Wrist strap
Included	<ul style="list-style-type: none"> • 1x quick charger • 1x 1500mAh Li-Ion battery • 1x blade for wood • 1x blade for metal • 1x BMC
 5 400338 060939 >	

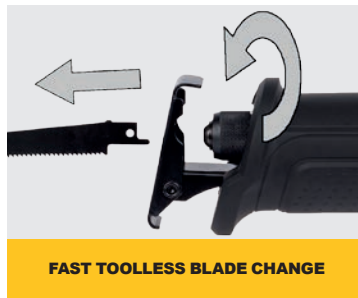

LI-ION one fits all POWX0079LI Angle grinder

HAAKSE SLIJPER // MEULEUSE D'ANGLE // WINKELSCHLEIFER // AMOLADORA ANGULAR



POWERPLUS
HIGH QUALITY TOOLS

18V
**ONE
FITS ALL**
HIGH STAR



POWX0079LI 18V Li-Ion + BMC

Battery capacity	1500mAh Li-Ion
Charging time	1 hour
Rotation speed	7000min ⁻¹
Max. disc diameter	115mm
Drive spindle thread	M14
Features	<ul style="list-style-type: none"> • Lock button • Auxiliary handle (2 pos) • Spindle lock • Ø115mm disc diameter (not incl.) • Soft touch • Soft grip • Safety guard • Quick clamp system
Included	<ul style="list-style-type: none"> • 1x quick charger • 1x 1500mAh Li-Ion battery • 1x auxiliary handle • 1x spanner • 1x BMC



QUICK CLAMP SYSTEM



**Ø115X22mm
DISC NOT INCLUDED**



SPINDLE LOCK BUTTON

**18V LI-ION
BATTERY 1500mAh
HIGH STAR®**
1h QUICK CHARGER



Drilling

Drills / screwdrivers

SCHROEFBOORMACHINES
PERCEUSES/VISSEUSES
BOHRSCHRAUBER
TALADROS/ATORNILLADORES

13-14

Li-ion drills / screwdrivers

LI-ION SCHROEFBOORMACHINES
PERCEUSES/VISSEUSES LI-ION
LI-ION BOHRSCHRAUBER
TALADROS/ATORNILLADORES LI-ION

15

Impact drills

KLOPBOORMACHINES
PERCEUSES À PERCUSSION
SCHLAGBOHRMASCHINEN
TALADROS PERCUTORES

16-17

Hammer drills

BOORHAMERS
MARTEAUX PERFORATEURS
BOHRHÄMMER
MARTILLOS PERFORADORES

18-19

Bench drills

KOLOMBOORMACHINES
FOREUSES À COLONNE
SÄULENBOHRMASCHINEN
TALADROS DE COLUMNA

20



POWX0052 & POWX0055

Drills/Screwdrivers

SCHROEFBOORMACHINES // PERCEUSES/VISSEUSES // BOHRSCHRAUBER // TALADROS/ATORNILLADORES



POWX0052

14.4V +BMC



POWX0055

18V +BMC

Battery capacity	1300mAh Ni-Cd	1300mAh Ni-Cd
Charging time	3-5 hours	1 hour
Rotation speed	0-350min ⁻¹ / 0-1250min ⁻¹	0-350min ⁻¹ / 0-1250min ⁻¹
Maximum torque	26Nm (16+1 torque positions)	30Nm (16+1 torque positions)
Chuck	Keyless Peacock chuck max. Ø10mm	Keyless Peacock chuck max. Ø10mm
Left/right	Yes	Yes
Features	<ul style="list-style-type: none"> • 2 speed • LED worklight • Forward/reverse knob • Soft grip • Quick stop 	<ul style="list-style-type: none"> • 2 speed • LED worklight • Forward/reverse knob • Soft grip • Quick stop
Included	<ul style="list-style-type: none"> • 1x 3-5h charger • 2x battery 1300mAh Ni-Cd • 1x BMC 	<ul style="list-style-type: none"> • 1x quick charger • 2x battery 1300mAh Ni-Cd • 1x BMC



POWX0057

Drill/Screwdriver

SCHROEFBOORMACHINE // PERCEUSE/VISSEUSE // BOHRSCHRAUBER // TALADRO/ATORNILLADOR



POWX0057
18V+ BMC

Battery capacity	3x 1200mAh
Charging time	3-5 hours
Rotation speed	0-400 / 0-1100min ⁻¹
Maximum torque	30Nm (20+1 torque positions)
Chuck	10mm keyless Sanou chuck
Left/right	Yes
Features	<ul style="list-style-type: none"> • 2 speed • LED worklight • LCD battery check • Forward/reverse knob • Soft grip • Magnetic plate • Quick stop • Wrist strap
Included	<ul style="list-style-type: none"> • 1x 3-5h charger • 3x battery 1200mAh Li-Ion • 6x 25mm bit (SL4/SL5/PZ1/PZ2/PH1/PH2) • 6x drill (1.5/2/3/4/5/6mm) • 1x magnetic bit holder: 60mm • 1x BMC



LED WORKLIGHT



10mm KEYLESS SANOU CHUCK



LCD BATTERY CHECK



LI-ION POWX0060LI, POW0062LI, POWX0065LI & POWX0068LI Drills/Screwdrivers

SCHROEFBOORMACHINES // PERCEUSES/VISSEUSES // BOHRSCHRAUBER // TALADROS/ATORNILLADORES

POWERPLUS
HIGH QUALITY TOOLS



	 POWX0060LI 3.6V Li-Ion	 POWX0062LI 12V Li-Ion + BMC	 POWX0065LI 14.4V Li-Ion + BMC	 POWX0068LI 18V Li-Ion + BMC
Battery capacity	1300mAh Li-Ion	1300mAh Li-Ion	1300mAh Li-Ion	1300mAh Li-Ion
Charging time	3-5 hours	3-5 hours	1 hour	1 hour
Rotation speed	180min ⁻¹	0-550min ⁻¹	0-350min ⁻¹ / 0-1250min ⁻¹	0-350min ⁻¹ / 0-1250min ⁻¹
Maximum torque	3Nm (16+1 torque positions)	15Nm (16+1 torque positions)	28Nm (16+1 torque positions)	32Nm (16+1 torque positions)
Chuck	1/4" quick release	Ø10mm Keyless Peacock chuck	Ø10mm Keyless Peacock chuck	Ø13mm Keyless Peacock chuck
Left/right	Yes	Yes	Yes	Yes
Features	<ul style="list-style-type: none"> • LED worklight • Battery status indication • Forward/reverse knob • Electric overload protection • Spindle lock • Use in 2 positions: folded or straight 	<ul style="list-style-type: none"> • LED worklight • Electric overload protection • Forward/reverse knob • Soft grip • Quick stop 	<ul style="list-style-type: none"> • 2 speed • LED worklight • Electric overload protection • Forward/reverse knob • Soft grip • Quick stop 	<ul style="list-style-type: none"> • 2 speed • LED worklight • Electric overload protection • Forward/reverse knob • Soft grip • Quick stop
Included	<ul style="list-style-type: none"> • 1x 3-5h charger • 1x battery 1300mAh Li-Ion • 12x 25mm bit: (PZ1 / PZ2 / PZ2 / PZ3 / PH1 / PH2 / PH2 / PH3 / SL3 / SL4 / SL6 / SL8) • 1x magnetic bit holder: 60mm 	<ul style="list-style-type: none"> • 1x 3-5h charger • 1x battery 1300mAh Li-Ion • 1x BMC 	<ul style="list-style-type: none"> • 1x quick charger • 1x battery 1300mAh Li-Ion • 1x BMC 	<ul style="list-style-type: none"> • 1x quick charger • 2x battery 1300mAh Li-Ion • 1x BMC
	 5 400338 053757 >	 5 400338 053788 >	 5 400338 053795 > 	 5 400338 053801 >  

POWX026 & POWX027

Impact drills

KLOPBOORMACHINES // PERCEUSES À PERCUSSION // SCHLAGBOHRMASCHINEN // TALADROS PERCUTORES



POWX026
710W



POWX027
910W

Voltage	230-240V~ 50Hz	230-240V~ 50Hz
Capacity	Concrete: 13mm Steel: 13mm Wood: 25mm	Concrete: 16mm Steel: 13mm Wood: 25mm
Rotation speed	0-2900min ⁻¹	0-3000min ⁻¹
Impact rate	0-52200 impacts per minute	0-54000 impacts per minute
Chuck	Ø13mm Key Sanou chuck	Ø13mm Keyless Sanou chuck + lock
Left/right	Yes	Yes
Features	<ul style="list-style-type: none"> • Key Sanou chuck • Soft grip • Forward/reverse knob • Lock-on button • 2 functions: drilling / impact drilling • Soft touch 	<ul style="list-style-type: none"> • Keyless Sanou chuck + lock • Soft grip • Forward/reverse knob • Lock-on button • 2 functions: drilling / impact drilling • Soft touch
Included	<ul style="list-style-type: none"> • 1x depth stop • 1x auxiliary handle 	<ul style="list-style-type: none"> • 1x depth stop • 1x auxiliary handle



2 FUNCTIONS



2 FUNCTIONS

POWX026

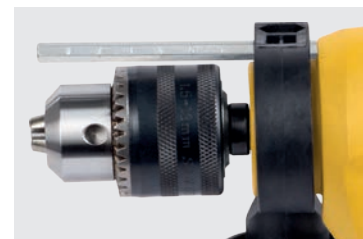

Ø13mm KEY SANOU CHUCK

POWX027



Ø13mm KEYLESS SANOU CHUCK + LOCK

POWX028

Impact drill

KLOPBOORMACHINE // PERCEUSE À PERCUSSION // SCHLAGBOHRMASCHINE // TALADRO PERCUTOR



POWERPLUS
HIGH QUALITY TOOLS



POWX028 1200W + BMC

Voltage	230-240V~ 50Hz
Capacity	Concrete: 16mm Steel: 13mm Wood: 40mm
Rotation speed	0-1200/0-3000min ⁻¹
Impact rate	0-48000 impacts per minute
Chuck	Ø13mm Keyless Sanou chuck + lock
Left/right	Yes
Features	<ul style="list-style-type: none"> • Keyless Sanou chuck + lock • Soft grip • Forward/reverse knob • Lock-on button • 2 functions: drilling / impact drilling • Soft touch
Included	<ul style="list-style-type: none"> • 1x depth stop • 1x auxiliary handle • 1x BMC



METAL Ø13mm KEYLESS SANOU CHUCK + LOCK



1ST GEAR / 2ND GEAR SELECTOR SWITCH



SWITCH DRILLING / IMPACT-DRILLING



POWX112

Hammer drill

BOORHAMER // MARTEAU PERFORATEUR // BOHRHAMMER // MARTILLO PERFORADOR



POWX112
1050W + BMC

Voltage	230-240V~ 50Hz
Capacity	Concrete: 26mm / Steel: 13mm Wood: 40mm
Rotation speed	0-1100min ⁻¹
Impact rate	0-5200 impacts per minute
Chuck	Key chuck with SDS connector
Left/right	Yes
Cable	3m
Features	<ul style="list-style-type: none"> • 4 functions: hammer drilling / hammering / drilling / chisel rotation • Light indicator for power and change of carbon brush • Soft grip
Included	<ul style="list-style-type: none"> • 3x SDS drill (Ø8/10/12x150mm) • 2x SDS chisel (1x flat chisel 20x250mm, 1x pointed chisel 250mm) • 1x Ø13mm key chuck (SDS adaptor) • 1x dust cap • 1x depth gauge • 1x auxiliary handle • 1x BMC



MODE SELECTOR

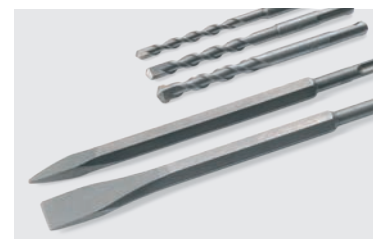

1x FLAT CHISEL 20x250mm
1x POINTED CHISEL 250mm
3x SDS DRILL (Ø8/10/12x150mm)



FORWARD/REVERSE SWITCH & SPEED CONTROLLER



4 FUNCTIONS

POWX1152 & POWX1155

Hammer drills

BOORHAMERS // MARTEAUX PERFORATEURS // BOHRHÄMMER // MARTILLOS PERFORADORES



POWX1152
1250W + BMC



POWX1155
1600W + BMC

Voltage	220-240V~ 50Hz	220-240V~ 50Hz
Capacity	Concrete: 30mm / Steel: 13mm Wood: 40mm	Concrete: 32mm / Steel: 13mm Wood: 40mm
Rotation speed	800min ⁻¹	800min ⁻¹
Impact rate	3900 impacts per minute	3900 impacts per minute
Chuck	Keyless chuck with SDS connector	Keyless chuck with SDS connector
Left/right	Yes	Yes
Cable	3m	3m
Features	<ul style="list-style-type: none"> • 3 functions: hammer drilling / hammering / drilling • Anti-vibration system • Soft grip 	<ul style="list-style-type: none"> • 4 functions: hammer drilling / hammering / drilling / chisel rotation • Double anti-vibration system • Soft grip
Included	<ul style="list-style-type: none"> • 3x SDS drill (Ø8/10/12x150mm) • 2x SDS chisel (1x flat chisel 22x250mm, 1x pointed chisel 250mm) • 1x Ø13mm Keyless chuck (SDS adaptor) • 1x dust cap • 1x depth gauge • 1x auxiliary handle • 1x BMC 	<ul style="list-style-type: none"> • 3x SDS drill (Ø8/10/12x150mm) • 2x SDS chisel (1x flat chisel 22 x 250mm, 1x pointed chisel 250mm) • 1x Ø13mm Keyless chuck (SDS adaptor) + lock • 1x dust cap • 1x depth gauge • 1x auxiliary handle • 1x BMC



3 FUNCTIONS



4 FUNCTIONS

POWX152 & POWX154

Bench drills

KOLOBOORMACHINES // PERCEUSES À COLONNE // SÄULENBOHRMASCHINEN // TALADROS DE COLUMNA



SAFETY GUARD



DEPTH STOP

CROSS HAIR LASER

INTEGRATED DRAWER

	 POWX152 350W	 POWX154 500W
Voltage	230V~ 50Hz	230V~ 50Hz
Rotation speed	580 - 2650min ⁻¹ (5)	425 - 2545min ⁻¹ (12)
Chuck	Ø13mm Sanou key chuck	Ø16mm Sanou key chuck
Table size	170x152mm with table extensions: 272x170mm	200x200mm with table extensions: 330x200mm
Height	650mm	850mm
Features	<ul style="list-style-type: none"> • Electric cross hair laser • 5 speed • Tilttable / extendable table • Safety guard • V-belt system 	<ul style="list-style-type: none"> • Electric cross hair laser • 12 speed • Tilttable / extendable table • Safety guard • V-belt system
	 5 400338 038518 >	 5 400338 038525 >
		

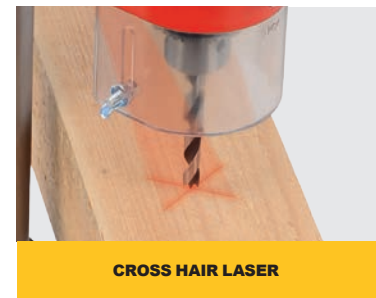

CROSS HAIR LASER



**TABLE CAN BE TURNED
HEIGHT-ADJUSTED AND EXTENDED**

Sanding, polishing & Grinding

Finishing sander

VLAKSCHUURMACHINE
PONCEUSE VIBRANTE
SCHWINGSCHLEIFER
LIJADORA ORBITAL

22

Wall/ceiling sander

MUUR- EN PLAFONDSCHUURDER
PONCEUSE POUR MURS ET PLAFONDS
WAND- UND DECKENSCHLEIFER
AMOLADORA PARA PAREDES Y TECHOS

30

Belt sander

BANDSCHUURMACHINE
PONCEUSE À BANDE
BANDSCHLEIFER
LIJADORA DE BANDA

23

Angle grinders

HAAKSE SLIJERS
MEULEUSES D'ANGLE
WINKELSCHLEIFER
AMOLADORAS ANGULARES

31

File belt sander

VIJL / BANDSCHUURMACHINE
LIME / PONCEUSE À BANDE
FEILE / BANDSCHLEIFER
LIMA / LIJADORA DE BANDA

24

Wall slotter

MUURFREES
RAINUREUSE À MAÇONNERIE
MAUERNUTFRÄSE
RANDURADORA DE PARED

32

Rotating sander

ROTARENDE SCHUURMACHINE
PONCEUSE ROTATIVE
EXZENTERSCHLEIFER
LIJADORA ROTO-ORBITAL

25

Bench grinders

BANKSLIJPMOLENS
TOURETS
TISCHSCHLEIFMASCHINEN
ESMERILADORAS DE BANCO

33

Palm sander

HANDPALMSCHUURMACHINE
PONCEUSE À MAIN
HANDSCHLEIFER
LIJADORA DE MANO

26

Multitool

MULTIGEREEDSCHAP
OUTIL POLYVALENT
MULTITOOL
HERRAMIENTA MULTITOOL

34

Triangular sander

DRIEHOEKSCHUURMACHINE
PONCEUSE TRIANGULAIRE
DREIECKSCHLEIFER
LIJADORA TRIANGULAR

27

Multi-use tool

MULTIFUNCTIONEEL GEREEDSCHAP
OUTILMULTI-USAGE
MULTIFUNKTIONSGERÄT
HERRAMIENTA MULTIFUNCIÓN

35

Angle polisher

HAAKSE HANDPOLIJSTMACHINE
POLISSEUSE D'ANGLE
WINKELPOLIERMACHINE
PULIDORA DE ÁNGULOS

28

Multi-function sharpener

MULTIFUNCTIONELE SLIJPMACHINE
AFFÛTEUSE MULTIFONCTIONNELLE
MULTIFUNKTIONSSCHLEIFER
AFILADORA MULTIFUNCIONES

36

Drywall sander

LANGNEKSCHUURMACHINE
PONCEUSE DE CLOISONS SÈCHES
TROCKENAUSBAUSCHLEIFER
LIJADORA PARA PANELES DE YESO

29



POWX0400 & POWX0440

Finishing sander

VLAKSCHUURMACHINE // PONCEUSE VIBRANTE // SCHWINGSCHLEIFER // LJADORA ORIBTAL



		
	POWX0400 220W + BMC	POWX0440 330W + BMC
Voltage	230-240V- 50Hz	230-240V- 50Hz
Oscillation speed	24000min ⁻¹	12000-22000min ⁻¹
Sanding surface	90x187mm	115x230mm
Cable	3m	3m
Features	<ul style="list-style-type: none"> • Switch on top for left & right handed people • Hook & loop system • Fast clamp system • Aluminium base (90x187mm) • Ergonomic soft grip + guide handle • Soft touch 	<ul style="list-style-type: none"> • Switch on top for left & right handed people • Hook & loop system • Fast clamp system • Aluminium base (115x230mm) • Ergonomic soft grip + guide handle • Soft touch
Included	<ul style="list-style-type: none"> • 1x sandpaper G240 • 1x dust collect box with microfilter • 1x BMC 	<ul style="list-style-type: none"> • 1x sandpaper G240 • 1x dust collect box with microfilter • 1x perforating plate • 1x BMC
		
		 



HOOK & LOOP SYSTEM



FAST CLAMP SYSTEM

POWX0460

Belt sander

BANDSCHUURMACHINE // PONCEUSE À BANDE // BANDSCHLEIFER // LIJADORA DE BANDA



POWERPLUS
HIGH QUALITY TOOLS

ADJUSTABLE AUXILIARY HANDLE
WITH SOFT GRIP

DUST COLLECT BOX
WITH MICROFILTER



BELT POSITIONING KNOB

3x SANDING BELTS
(G60/80/120)



POWX0460 950W + BMC

Voltage	230-240V- 50Hz
Belt speed	0-380 m/min
Belt size	533x76mm
Sanding surface	140x75mm
Cable	3m

Features

- Speed control dial
- Adjustable screw for belt tension
- Adjustable auxiliary handle
- Soft touch

Included

- 3x sanding belt (G60/80/120)
- 1x dust collect box with micro filter
- 1x BMC



VARIABLE SPEED



ADJUSTABLE AUXILIARY HANDLE



DUST ADAPTOR /
DUST COLLECT BOX WITH MICROFILTER

POWX139

File belt sander

VIJL / BANDSCHUURMACHINE // LIME / PONCEUSE À BANDE // FEILE / BANDSCHLEIFER // LIMA / LIJADORA DE BANDA



ADJUSTABLE ANGLE LEVER

ADJUSTABLE STRUT ARM KNOB

LOCK-ON BUTTON

DUST BAG

10x SANDING BELT
(3x G40/4xG60/3xG120)



POWX139
400W + BMC

Voltage	230-240V~ 50Hz
Belt speed	300-1700 m/min
Belt size	13x457mm
Cable	3m

Features	<ul style="list-style-type: none"> • Rotatable head • Adjustable angle lever • Tension spanner • Adjustable strut arm knob • Lock-on button • Soft grip • Soft touch
----------	---

Included	<ul style="list-style-type: none"> • 10x sanding belt (3xG40/4xG60/3xG120) • 1x dust bag • 1x BMC
----------	--



**IDEAL FOR FINISHING AND SANDING
HARD TO REACH PLACES**



**EASY TO USE SPANNER FOR TENSION
& REPLACING SANDING BELTS**



ROTATABLE HEAD





POWX0470

Rotating sander

ROTERENDE SCHUURMACHINE // PONCEUSE ROTATIVE // EXZENTERSCHLEIFER // LIJADORA ROTO-ORIBTAL



POWX0470
450W + BMC

Voltage	230-240V~ 50Hz
Oscillation speed	0-26000min ⁻¹
Sanding surface	Ø125mm
Cable	3m
Features	<ul style="list-style-type: none"> • Switch on top for left & right handed people • Variable speed • Hook & loop system • Adjustable auxiliary handle • Ergonomic soft grip + guide handle • Soft touch
Included	<ul style="list-style-type: none"> • 3x sandpaper (G60/120/240) • 1x dust collect box + micro filter • 1x BMC



HOOK & LOOP SYSTEM



DUST COLLECT BOX WITH MICROFILTER



ADJUSTABLE AUXILIARY HANDLE

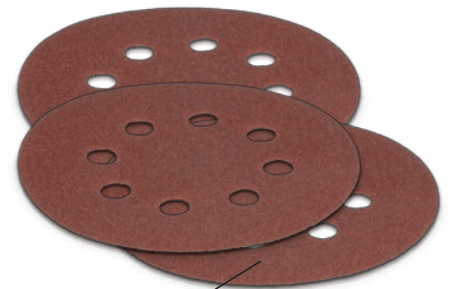

3x SANDPAPER (G60/120/240)

POWX0480

Palm sander

HANDPALMSCHUURMACHINE // PONCEUSE À MAIN // HANDSCHLEIFER // LIJADORA DE MANO



POWX0480
220W + BMC

Voltage	230-240V~ 50Hz
Oscillation speed	0-26000min ⁻¹
Sanding surface	140x140x80mm
Cable	3m
Features	<ul style="list-style-type: none"> • Switch for left & right handed people • Hook & loop system • Soft touch • Soft grip
Included	<ul style="list-style-type: none"> • 1x sandpaper (G120) • 1x dust collect box + micro filter • 1x BMC





POWERPLUS
HIGH QUALITY TOOLS

POWX0490

Triangular sander

DRIEHOEKSCHUURMACHINE // PONCEUSE TRIANGULAIRE // DREIECKSCHLEIFER // LIJADORA TRIANGULAR



POWX0490
300W + BMC

Voltage	230-240V~ 50Hz
Oscillation speed	12000-22000min ⁻¹
Sanding surface	90x90x90mm
Cable	3m
Features	<ul style="list-style-type: none"> • Switch on top for left & right handed people • Hook & loop system • Speed control • Soft touch • Soft grip
Included	<ul style="list-style-type: none"> • 3x sandpaper (G60/120/240) • 1x dust adaptor • 1x BMC



HOOK AND LOOP SYSTEM



DUST ADAPTOR

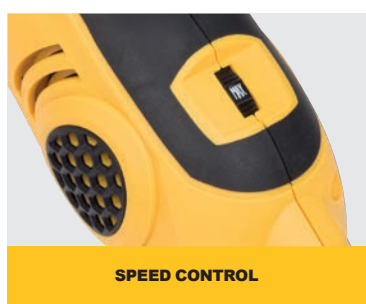

SPEED CONTROL

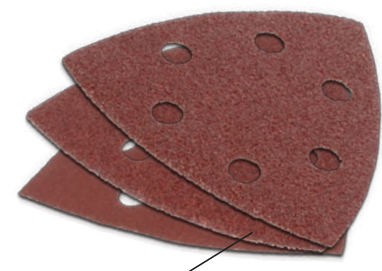

3x SANDPAPER (G60/120/240)

POWX0474

Angle polisher

HAAKSE HANDPOLIJSTMACHINE // POLISSEUSE D'ANGLE // WINKELPOLIERMASCHINE // PULIDORA DE ÁNGULOS



POWX0474
1200W + BMC

Voltage	230V- 50Hz
Rotation speed	600-3300min ⁻¹
Pad size	Ø180mm
Cable	3m
Drive spindle thread	M14
Features	<ul style="list-style-type: none"> • Quick clamp system • Lock-on button • U-shaped handle • Constant speed control • Spindle lock • Variable speed • Soft start
Included	<ul style="list-style-type: none"> • 1x U-shaped handle • 1x sponge pad Ø180mm • 1x polishing bonnet Ø180mm • 5x sandpaper G120 Ø180mm • 1x BMC



HOOK & LOOP GRIP PAD FOR EASY EXCHANGE OF SANDING SHEETS AND POLISHING PAD



U-SHAPED HANDLE FOR COMFORT AND SECURE GRIP

POWX0476

Drywall sander

LANGNEKSCHUURMACHINE // PONCEUSE DE CLOISONS SÈCHES // TROCKENAUSBAUSCHLEIFER // LJADORA PARA PANELES DE YESO



POWERPLUS
HIGH QUALITY TOOLS



HOOK & LOOP SYSTEM

SPEED CONTROL

1m SOFT TUBE WITH ADAPTORS EXTENDABLE UP TO 4m



1.80m

	POWX0476 710W + CARRYING BAG
Voltage	220-240V- 50Hz
Oscillation speed	0-2400min ⁻¹ (6 speed)
Sanding surface	Ø225mm
Flexible hose	1m (extendable up to 4m)
Cable	4m
Features	<ul style="list-style-type: none"> • Maximum reach with telescopic shaft (415-695mm) • Hook & loop system • Partially detachable cap for better accessibility in corners • Sanding head can be fixated with blocking pin • External brush cap for faster carbon changes • Soft grip handle
Included	<ul style="list-style-type: none"> • 1x extendable vacuum cleaner hose • 1x block pin • 6x sandpaper (2xG60/2xG100/2xG240) • 1x carrying bag
	 5 400338 060793 >
	

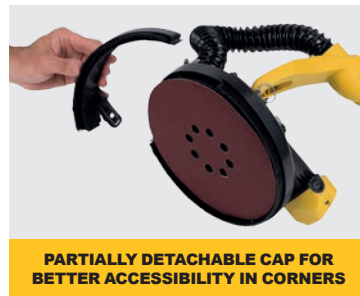

PARTIALLY DETACHABLE CAP FOR BETTER ACCESSIBILITY IN CORNERS



TELESCOPIC SHAFT 415-695mm



6x SANDPAPER (2xG60/2xG100/2xG240)

CARRYING BAG

POWX0478

Wall/ceiling sander



MUUR- EN PLAFONDSCHUURDER // PONCEUSE POUR MURS ET PLAFONDS // WAND - UND DECKENSCHLEIFER // AMOLADORA PARA PAREDES Y TECHOS



POWX0478
1220W

Voltage	220-240V- 50Hz
Rotation speed	1500-2300min ⁻¹ (5 speed)
Sanding surface	Ø225mm
Cable	4m
Features	<ul style="list-style-type: none"> • Speed control • Soft start • Adjustable suction power • Self suction function and can be used with a vacuum cleaner • Lock-on button
Included	<ul style="list-style-type: none"> • 1x auxiliary handle • 1x dust bag with carrying belt • 1x 2m flexible vacuum hose • 8x sandpaper (2xG150/2xG180/2xG240/2xG400)



GRINDING PAD WITH VALVE TO ADJUST SUCTION



SPEED CONTROL



DUST BAG WITH CARRYING BELT



8x SANDPAPER (2xG150/2xG180/2xG240/2xG400)



POWERPLUS
HIGH QUALITY TOOLS

POWX0610, POWX0613 & POWX0617

Angle grinders

HAAKSE SLIJPERS // MEULEUSES D'ANGLE // WINKELSCHLEIFER // AMOLADORAS ANGULARES













**AUXILIARY HANDLE
(2 OR 3 POSITIONS)**

SOFT GRIP

METAL SAFETY GUARD

QUICK CLAMP SYSTEM

SPINDLE LOCK

	 POWX0610 900W	 POWX0613 1200W	 POWX0617 2500W + BMC
Voltage	230-240V- 50Hz	230-240V- 50Hz	230-240V- 50Hz
Rotation speed	12000min ⁻¹	12000min ⁻¹	6500min ⁻¹
Disc diameter	Ø115x22.2mm (not included)	Ø125x22.2mm (not included)	Ø230x22.2mm (not included)
Spindle thread	M14	M14	M14
Cable	3m	3m	3m
Features	<ul style="list-style-type: none"> • Soft grip • Spindle lock for safe and easy disc replacement • Quick clamp system • Lock-on switch • Metal safety guard • Soft touch 	<ul style="list-style-type: none"> • Soft grip • Spindle lock for safe and easy disc replacement • Quick clamp system • Lock-on switch • Metal safety guard • Soft touch 	<ul style="list-style-type: none"> • Rotatable handle • Soft grip • Spindle lock for safe and easy disc replacement • Quick clamp system • Lock-on switch • Metal safety guard • Soft start • Soft touch
Included	<ul style="list-style-type: none"> • 1x auxiliary handle (2 positions) • 1x spanner 	<ul style="list-style-type: none"> • 1x auxiliary handle (3 positions) • 1x spanner 	<ul style="list-style-type: none"> • 1x auxiliary handle (3 positions) • 1x spanner • 1x BMC
	 5 400338 055171 >	 5 400338 055188 >	 5 400338 055195 >
			 

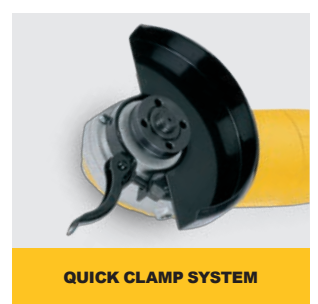

POWX0650

Wall slotter

MUURFREES // RAINUREUSE À MAÇONNERIE // MAUERNUTFRÄSE // RANURADORA DE PARED



2x DIAMOND DISC
Ø150x2.0x22.23mm



POWX0650
1800W + BMC

Voltage	230-240V~ 50Hz
Rotation speed	5000min ⁻¹
Diamond disc size	Ø150x2.0x22.23mm
Cutting depth	max. 45mm
Cutting width	14/24/34/44mm

- Features
- Wide enough to fit 2 electric pipes
 - Dust adaptor
 - Overload protection
 - Lock button

- Included
- 2x diamond discs
 - 1x wrench
 - 1x BMC



ADJUSTABLE WIDTH 14/24/34/44mm
WIDE ENOUGH TO FIT 2 ELECTRIC PIPES

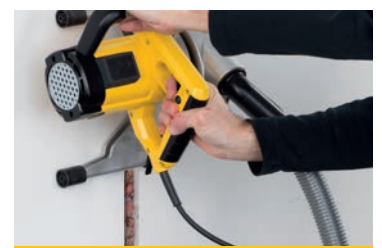

DUST ADAPTOR



SCALE CUTTING DEPTH



POWX1230 & POWX1250

Bench grinders

BANKSLIJPMOLENS // TOURETS // TISCHSCHLEIFMASCHINEN // ESMERILADORAS DE BANCO



		
	POWX1230 350W dry	POWX1250 350W wet&dry
Voltage	230V~ 50Hz	230V~ 50Hz
Rotation speed	2950min ⁻¹	2950min ⁻¹
Wheel diameter	2x Ø150mm DRY	1x Ø150mm DRY 1x Ø200mm WET
Features	<ul style="list-style-type: none"> Powerful induction motor ensures smooth running Built-in tray LED worklight Ball bearing support motor shaft for long tool life Adjustable workrest for longer wheel life 	<ul style="list-style-type: none"> Powerful induction motor ensures smooth running Built-in tray LED worklight Ball bearing support motor shaft for long tool life Adjustable workrest for longer wheel life
Included	<ul style="list-style-type: none"> 1 set eye shield 1x worklight 3V - 3W 	<ul style="list-style-type: none"> 1 set eye shield 1x worklight 3V - 3W
		
	DRY	WET / DRY

EXTRA GRIND STONES DRY
POWX123A Grind stone dry / grain 36
Size: Ø150x20mm
For use with: POWX1230 / POWX1250

POWX123B Grind stone dry / grain 80
Size: Ø150x40mm
For use with: POWX1230

EXTRA GRIND STONES WET
POWX125A Grind stone wet / grain 80
Size: Ø200x40mm
For use with: POWX1250

POWX1340

Multitool

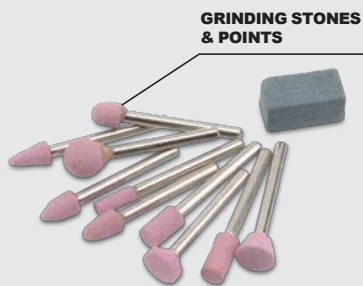
MULTIGEREEDSCHAP // OUTIL POLYVALENT // MULTITOOL // HERRAMIENTA MULTITOOL



GRINDING STONES & POINTS



WIRE BRUSHES, FILES & DRILLS



SANDING WHEELS



POWX1340
180W + BMC

Voltage	230-240V~ 50Hz
Rotation speed	10000-34000min ⁻¹
Chuck	Ø10/15mm
Accessories	100 pcs

Features	<ul style="list-style-type: none"> • Lock button • High quality digital display • 2 LED lights • Tile drill with depth gauge • Table clamp & telescopic arm • Flexible tube • Chainsaw sharpening kit • Soft touch • Soft grip
----------	---

Included	<ul style="list-style-type: none"> • 100x accessories • 1x BMC
----------	--



INCLUDING: TABLE CLAMP, TELESCOPIC ARM & FLEXIBLE TUBE



CHAINSAW SHARPENING KIT



TILE DRILL WITH DEPTH GAUGE

POWX1345

Multi-use tool

MULTIFUNCTIONEEL GEREEDSCHAP // OUTIL MULTI-USAGE // MUTLIFUNKTIONSGERÄT // HERRAMIENTA MULTIFUNCIÓN



POWERPLUS
HIGH QUALITY TOOLS



POWX1345 300W + BMC

Voltage	230V~ 50Hz
Rotation speed	15000-22000min ⁻¹
Chuck	Ø10/15mm
Max. disc diameter	Ø115mm
Features	<ul style="list-style-type: none"> • Speed control • Quick clamp system • On/off switch on top for left and right handed people • Soft touch • Soft grip
Included	<ul style="list-style-type: none"> • 5x sandpaper (G60/G100/2xG120/G240) • 1x sanding pad • 1x segment blade • 1x plunge cut saw • 1x shovel blade • 1x BMC



QUICK CLAMP SYSTEM



DUST ADAPTOR FOR SANDING



PLASTIC BOX FOR ACCESSORIES



POWX1350

Multi-function sharpener

MULTIFUNCTIONELE SLIJPMACHINE // AFFÛTEUSE MULTIFONCTIONNELLE
MULTIFUNKTIONSSCHLEIFER // AFILADORA MULTIFUNCIONES

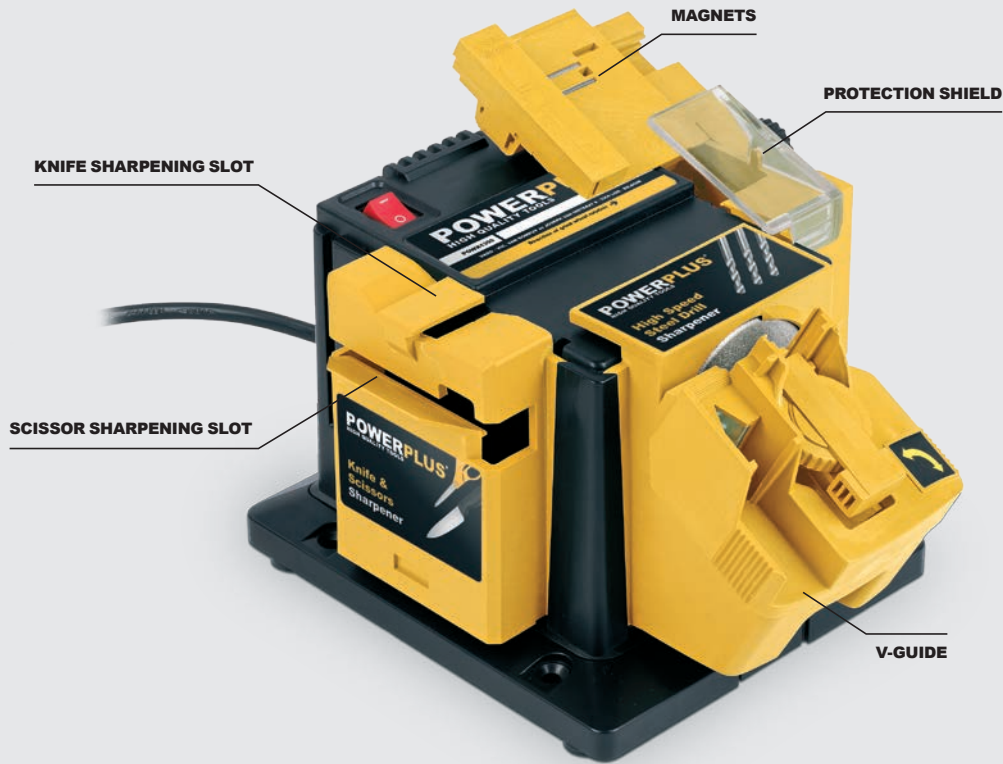

POWX1350
96W

Voltage	230-240V~ 50Hz
Rotation speed	1350min ⁻¹
Capacity	drill diameter Ø4mm - 13mm chisel & plane width 6mm - 51mm
Features	<ul style="list-style-type: none"> • Knife sharpening slot • Scissor sharpening slot • Drill sharpening slot • Adjustable grinding angle 15°-50° for chisel sharpening slot + magnets



SHARPENS ALL HIGH SPEED STEEL DRILL BITS FROM Ø4 - 13mm



KNIFE AND SCISSORS SHARPENING SLOT



CHISEL SHARPENING SLOT - ADJUSTABLE GRINDING ANGLE FROM 15° - 50° CHISEL & PLANE BLADE WIDTH 6 - 51mm

Sawing

Jigsaws

DECOUPERZAGEN
SCIES SAUTEUSES
STICHSÄGEN
SIERRAS DE CALAR

38

Roller support stand

ROLBOK
SERVANTE À ROULEAU
ROLLBOCK
SOPORTE CON RODILLO

47

Reciprocating saw

RECIPROZAAG
SCIE SABRE
SÄBELSÄGE
SIERRA DE ESPADA

39

Mitre & table saw

TAFEL-/VERSTEKZAAG
SCIE À ONGLET/SCIE À TABLE
KAPP- UND GEHRUNGSSÄGE/TISCHKREISSÄGE
INGLETADORA/SIERRA DE MESA

48-49

Circular saws

CIRKELZAGEN
SCIES CIRCULAIRES
HANDKREISSÄGEN
SIERRAS CIRCULARES

40

Table saw

TAFELZAAG
SCIE À TABLE
TISCHKREISSÄGE
SIERRA DE MESA

50

Plunge saw

INVALZAAG
SCIE PLONGEANTE
TAUCHSÄGE
SIERRA DE INMERSIÓN

41

Band saw

BANDZAAG
SCIE À BANDE
BANDSÄGE
SIERRA DE BANDA

51

Mini circular saw

MINI CIRKELZAAG
MINI SCIE CIRCULAIRE
MINI HANDKREISSÄGE
MINI SIERRA CIRCULAR

42

Scroll saw

FIGUURZAAGMACHINE
SCIE À CHANTOURNER
DEKUPIERSÄGE
SIERRA MARQUETERÍA

52

Dual saws

DUBBELZAGEN
SCIES DOUBLE LAME
ZWEIBLÄTTERSÄGEN
SIERRAS DOBLE DISCO

43

Tile cutters

TEGELSNIJDERS
COUPE-CARRELAGES
FLIESENSCHNEIDER
CORTADORAS AZULEJOS

53

Mitre saws

VERSTEKZAGEN
SCIES À ONGLET
KAPP-UND GEHRUNGSSÄGEN
INGLETADORAS

44-46



POWX0330 & POWX0360

Jigsaws

DECOUPEERZAGEN // SCIÉS SAUTEUSES // STICHSÄGEN // SIERRAS DE CALAR



	 POWX0330 650W	 POWX0360 810W + BMC
Voltage	230-240V~ 50Hz	230-240V~ 50Hz
Capacity	Steel: 8mm / Wood: 65mm	Steel: 10mm / Wood: 80mm
Rotation speed	800-3000min ⁻¹	800-3000min ⁻¹
Pendulum	4 positions	4 positions
Cable	3m	3m
Features	<ul style="list-style-type: none"> • Steel base • Quick blade change • Pendulum action (4 pos.) • Adjustable base 45° left/right • Speed control • Lock button • Dust blowing function (on/off switch) • Soft touch • Soft grip 	<ul style="list-style-type: none"> • Laser + LED light • Aluminium base • Quick blade change • Pendulum action (4 pos.) • Adjustable base 45° left/right • Speed control • Lock button • Dust blowing function (on/off switch) • Soft touch • Soft grip
Included	<ul style="list-style-type: none"> • 2x wood blade • 1x metal blade • 1x side guide • 1x dust adaptor 	<ul style="list-style-type: none"> • 4x wood blade • 2x metal blade • 1x side guide • 1x dust adaptor • 1x BMC
	 5 400338 057595 >	 5 400338 056345 >
	 VARIABLE SPEED	 4 PENDULUM FUNCTIONS POSITIONS
	 VARIABLE SPEED	 4 PENDULUM FUNCTIONS POSITIONS



ADJUSTABLE BASE 45° LEFT/RIGHT (QUICK ADJUSTABLE BASE - POWX0360)



QUICK BLADE CHANGE

POWX0396

Reciprocating saw

RECIPROZAAG // SCIE SABRE // SÄBELSÄGE // SIERRA DE ESPADA



POWERPLUS
HIGH QUALITY TOOLS



POWX0396
720W

Voltage	230-240V~ 50Hz
Capacity	Steel/alu/plastic: 90mm Wood: 115mm
Rotation speed	0-2500min ⁻¹
Cable	3m

- Features
- Quick blade change
 - Rotatable handle 5 positions
 - Adjustable pivot shoe & double swaying base
 - Speed control
 - Lock button
 - Soft touch
 - Soft grip

- Included
- 1x wood blade
 - 1x metal blade
 - 1x hex wrench



QUICK BLADE CHANGE



ROTATABLE HANDLE (5 POSITIONS)





ADJUSTABLE PIVOT SHOE & DOUBLE SWAYING BASE (HEX KEY INCLUDED)

POWX0520 & POWX0550

Circular saws

CIRKELZAGEN // SCIES CIRCULAIRES // HANDKREISSÄGEN // SIERRAS CIRCULARES



	 POWX0520 1500W (Ø185mm)	 POWX0550 1800W (Ø210mm)+BMC
Voltage	230-240V~ 50Hz	230-240V~ 50Hz
Max. capacity	90°: 64mm / 45°: 40mm	90°: 70mm / 45°: 45mm
Rotation speed	4500min ⁻¹	5000min ⁻¹
Saw blade	Ø185x20mm	Ø210x30mm
Cable	3m	3m
Features	<ul style="list-style-type: none"> • Laser • Quick clamp for depth setting • Aluminium base • Safety guard • Soft touch • Soft grip 	<ul style="list-style-type: none"> • Laser + LED light • Quick clamp for depth setting • Aluminium base • Safety guard • Soft touch • Soft grip
Included	<ul style="list-style-type: none"> • 1x TCT saw blade 24T • 1x side guide • 1x Allen key 	<ul style="list-style-type: none"> • 1x TCT saw blade 60T • 1x side guide • 1x Allen key
	 5 400338 057526 >	 5 400338 057533 >

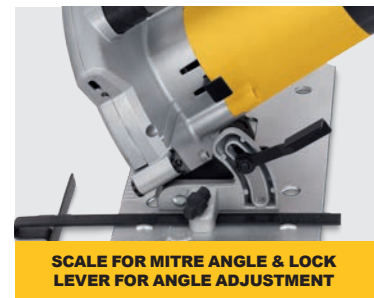

POWX0561

Plunge saw

INVALZAAG // SCIE PLONGEANTE // TAUCHSÄGE // SIERRA DE INMERSIÓN

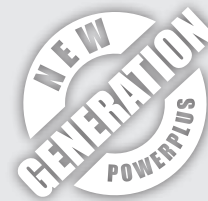

POWERPLUS
HIGH QUALITY TOOLS



POWX0561
1200W (Ø165mm)

Voltage	230-240V~ 50Hz
Max. capacity	With guide rail: 90°: 54mm / 45°:38mm Without guide rail: 90°: 58mm / 45°:42mm
Rotation speed	5500min ⁻¹
Saw blade	Ø165x20mm
Cable	3m
Features	<ul style="list-style-type: none"> • Anti-kickback • Mode selector: change saw blade, plunge cut & marked cut • Shaft lock • Allows bevel cuts • Guide rail for exact cutting • Soft grip
Included	<ul style="list-style-type: none"> • 1x TCT saw blade 24T • 2x clamp • 4x guide rail segment

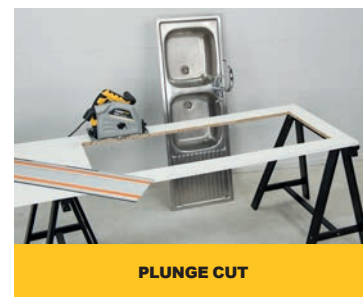

EXTRA GUIDE RAIL SEGMENT

POWX0561X

2x 33cm rail + 2x rail connector set



For use with : POWX0561

POWX1365MB

Mini circular saw

MINI CIRKELZAAG // MINI SCIE CIRCULAIRE // MINI HANDKREISSÄGE // MINI SIERRA CIRCULAR



	
<p>POWX1365MB 600W</p>	
Voltage	220-240V~ 50Hz
Rotation speed	5500min ⁻¹
Saw blade	TCT blade: Ø89x10mm 24T HSS blade: Ø89x10mm 80T Diamond disc: Ø89x10mm
Cable	3m
Features	<ul style="list-style-type: none"> • Laser • Safety switch • One hand operation • LED power indicator • Soft grip
Included	<ul style="list-style-type: none"> • 1x mitre base • 1x TCT saw blade • 1x HSS saw blade • 1x diamond disc • 1x side guide • 1x dust extraction hose
 <p>5 400338 066573 ></p>	

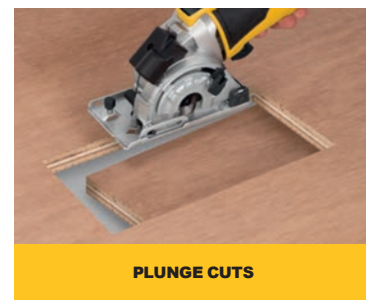
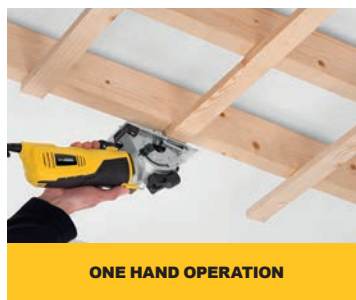

POWX0680 & POWX0682

Dual saws

DUBBELZAGEN // SCIÉS DOUBLE LA ME // ZWEI-BLÄTTERSÄGEN // SIERRAS DOBLE DISCO

PATENTED **DUALSAW**[®]
FOR POWERPLUS



POWERPLUS
HIGH QUALITY TOOLS

DESTROYER



**PATENTED SYSTEM
COUNTER ROTATING
SAW BLADES**

ANTI-KICKBACK

AUXILIARY HANDLE

PRECISE, SMOOTH & EASY CUTS

LUBRICATION SYSTEM

WAX STICKS



POWX0680
1050W + BMC



POWX0682
1500W + BMC

Voltage	230-240V - 50Hz	230-240V - 50Hz
Rotation speed	5500min ⁻¹	4200min ⁻¹
Saw blades	A: Ø125x28mm 32T B: Ø125x12mm 32T	A: Ø160x32mm 48T B: Ø160x12mm 48T
Cutting depth	30mm	45m
Cable	2.5m	3m
Features	<ul style="list-style-type: none"> • Dual saw patented system • Percise, smooth and easy cuts • Two blades rotate in opposite direction • Lubrication system • No kickback & less sparks • Spindle lock • Safety guard • Soft grip 	<ul style="list-style-type: none"> • Dual saw patented system • Percise, smooth and easy cuts • Two blades rotate in opposite direction • Lubrication system • No kickback & less sparks • Spindle lock • Safety guard • Soft grip
Included	<ul style="list-style-type: none"> • 2x tungsten blade • 10x wax stick • 1x auxiliary handle with soft grip • 1x dust adaptor • 1x BMC 	<ul style="list-style-type: none"> • 2x tungsten blade • 10x wax stick • 1x auxiliary handle with soft grip • 1x dust adaptor • 1x BMC

Cut through hard and soft woods, hard metals, soft metals, plastics, formica, PVC, aluminium, corrugated steel, brass, copper, iron, industrial grade rebar, ...



NO KICKBACK & LESS SPARKS

ACCESSORIES

POWX0680A - Ø125mm - 32T

Set: 2pcs / For use with: POWX0680



POWX0682A - Ø160mm - 48T

Set: 2pcs / For use with: POWX0682



POWX0680E - WAX STICKS

25pcs / For use with: POWX0680 & POWX0682



POWX070 Mitre saw

VERSTEKZAAG // SCIE À ONGLET // KAPP-UND GEHRUNGSSÄGE // INGLETADORA

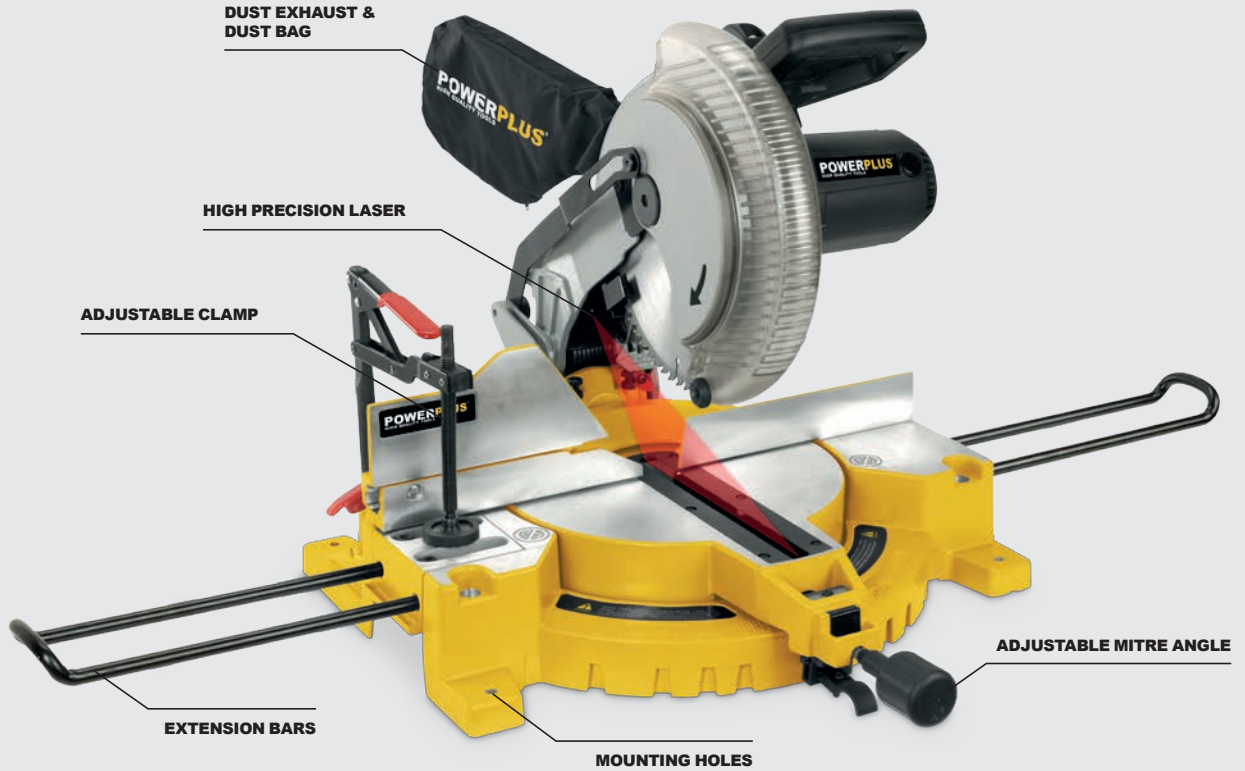

POWX070 1800W

Voltage	230V~ 50Hz
Rotation speed	4800min ⁻¹
Max. capacity	Depth: 50mm Width: 165mm
Cutting angle	90° - 45°
Table rotation	90° - 45°
Blade size	Ø255x30mm
Cable	2m
Features	<ul style="list-style-type: none"> • High precision laser (batteries incl.) • Soft start • Heavy duty base with side guides and adjustable clamp
Included	<ul style="list-style-type: none"> • 1x TCT saw blade 60T • 2x extension bar • 1x adjustable clamp • 1x dust bag



POWX075

Telescopic mitre saw

TELESCOPIsche VERSTEKZAAG // SCIE À ONGLET TÉLÉSCOPIQUE // TELESKOPISCHE KAPP-UND GEHRUNGSSÄGE // INGLETADORA TELESCÓPICA



POWX075
2000W

Voltage	230-240V~ 50Hz
Rotation speed	4200min ⁻¹
Max. capacity	Depth: 95mm Width: 310mm
Cutting angle	90° - 45°
Table rotation	90° - 45°
Blade size	Ø305x30mm
Cable	3m
Features	<ul style="list-style-type: none"> • High precision laser (batteries incl.) • Soft start • Heavy duty base with side guides and adjustable clamp
Included	<ul style="list-style-type: none"> • 1x TCT saw blade 80T • 2x extension bar • 1x adjustable clamp • 1x dust bag • 1x metal support stand + rubber feet



MAX. CUTTING CAPACITY MITRE SAW
90° x 90°: 95x310mm
45° x 90°: 95x215mm



MAX. CUTTING CAP. MITRE SAW - BEVEL
90° x 45°: 60x310mm
45° x 45°: 60x215mm



POWX077

Telescopic mitre saw

TELESCOPISCHE VERSTEKZAAG // SCIE À ONGLET TÉLÉSCOPIQUE // TELESKOPISCHE KAPP-UND GEHRUNGSSÄGE // INGLETADORA TELESCÓPICA

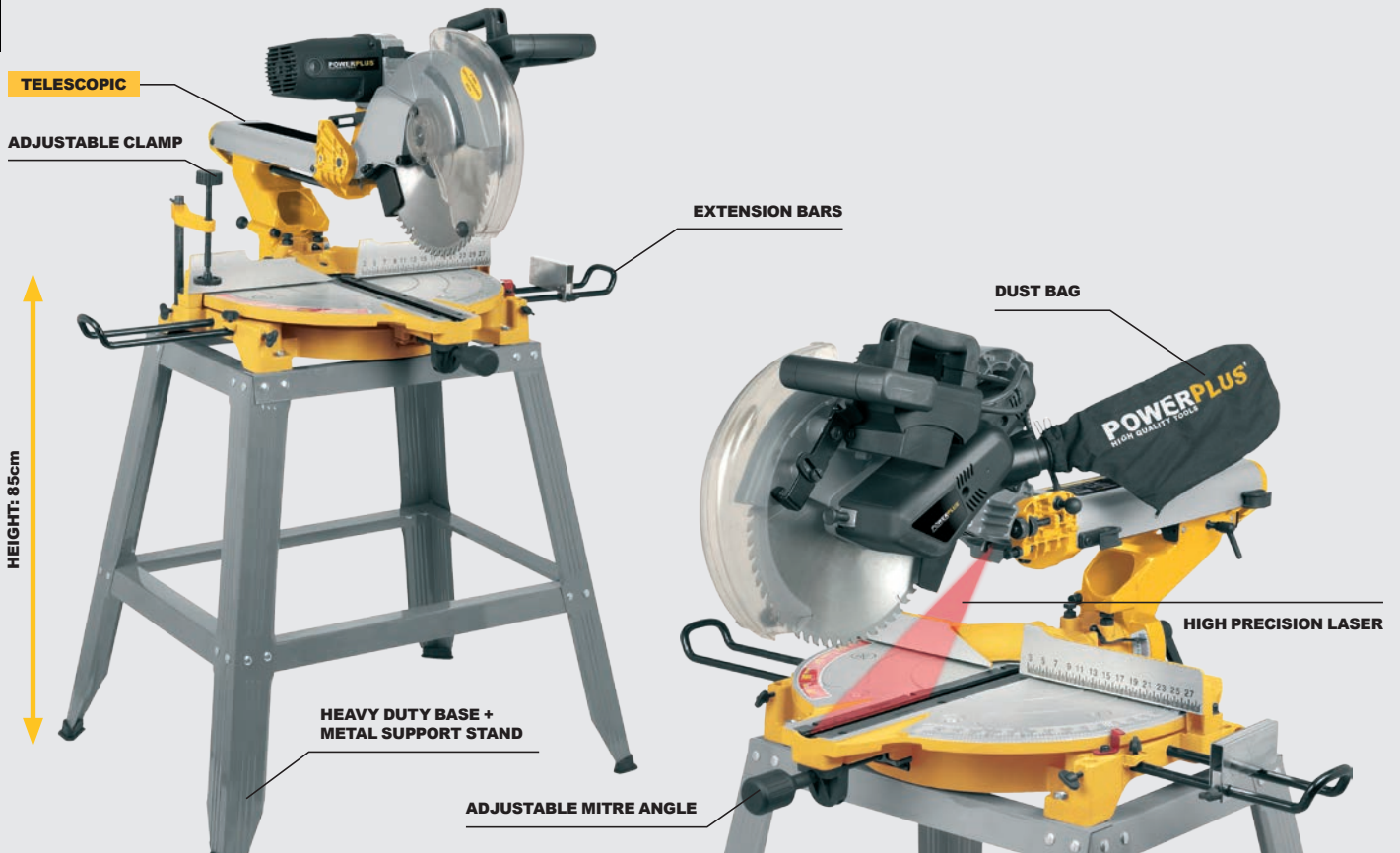

POWX077
1600W

Voltage	230V~ 50Hz
Rotation speed	4200min ⁻¹
Max. capacity	Depth: 95mm Width: 310mm
Cutting angle	90° - 45°
Table rotation	90° - 45°
Blade size	Ø305x30mm
Cable	3m
Features	<ul style="list-style-type: none"> • High precision laser (batteries incl.) • Soft start • Heavy duty base with side guides and adjustable clamp
Included	<ul style="list-style-type: none"> • 1x TCT saw blade 80T • 2x extension bar • 1x dust bag • 1x metal stand + rubber feet



LOW NOISE: DOUBLE BELT TRANSMISSION



TELESCOPIC FUNCTION



MAX. CUTTING CAPACITY MITRE SAW
90° x 90°: 95x310mm
45° x 90°: 65x310mm



MAX. CUTTING CAP. MITRE SAW - BEVEL
90° x 45°: 95x215mm
45° x 45°: 65x215mm

POWX0700T

Roller support stand

ROLBOK // SERVANTE À ROULEAU // ROLLBOCK // SOPORTE CON RODILLO



WEIGHT CAPACITY



POWX0700T
68-108cm

Min. height	68cm
Max. height	108cm
Max. weight	60kg
Features	<ul style="list-style-type: none">• Very solid• Very simple assembly



SUPPORT FOR STATIONARY SAW



ADJUSTABLE HEIGHT

POWX0782

Mitre saw with uppertable

VERSTEKZAAG MET BOVENTAFEL // SCIE À ONGLET AVEC TABLE SUPÉRIEURE // KAPP-UND GEHRUNGSSÄGE MIT OBERTISCH // SIERRA INGLETADORA CON MESA SUPERIOR

MITRE SAW

90° x 90° : 70x110mm
45° x 90° : 40x110mm
90° x 45° : 70x70mm
45°(L) x 45° : 35x60mm
45°(R) x 45° : 40x90mm

ADJUSTABLE CLAMP

VARIABLE ANGLE GUIDE FOR TABLE SAW

MOUNTING HOLES

SIDE FENCE

TABLE SAW

CUTTING CAP. 90°: 46mm

ADJUSTABLE MITRE ANGLE



POWX0782
1800W

Voltage	220-240V- 50Hz
Rotation speed	5000min ⁻¹
Max. capacity	Depth: 70mm Width: 110mm
Cutting angle	90° - 45°
Table rotation	90° - 45°
Blade size	Ø254x30mm
Table size	430x300mm
Cable	2.5m
Features	<ul style="list-style-type: none"> • Convertible duo-action cutting Mitre saw & table saw • Heavy duty base with side fence and variable angle guide
Included	<ul style="list-style-type: none"> • 1x TCT saw blade 60T • 1x adjustable clamp • 1x dust bag & 1x dust adaptor • 1x side fence • 1x variable angle guide • 1x push stick



Mitre saw & table saw Flipover POWX0760

TAFEL- / VERSTEKZAAG // SCIE À ONGLET / À TABLE //
KAPP-UND GEHRUNGSSÄGE/ TISCHKREISSÄGE // INGLETADORA / SIERRA DE MESA

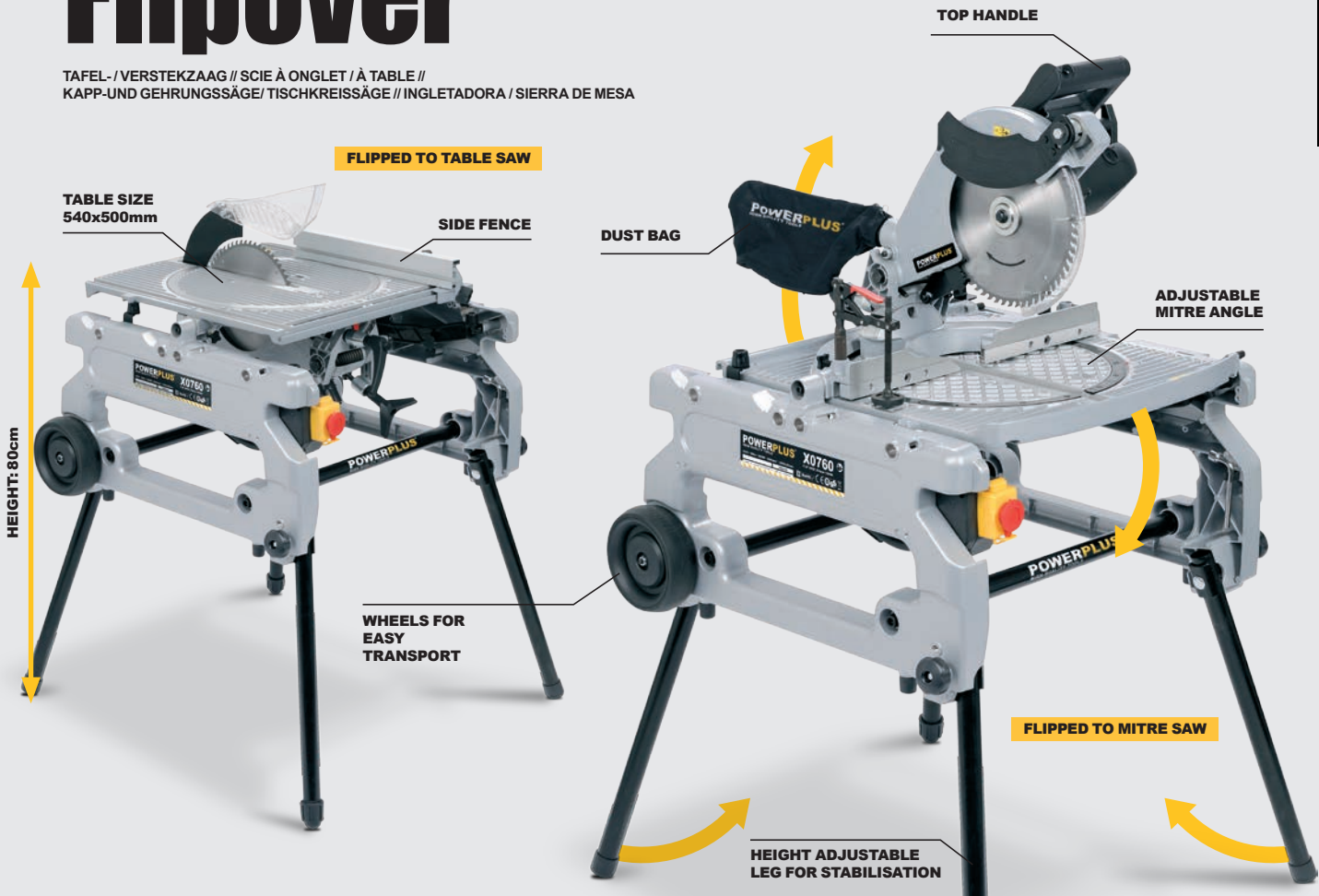

POWX0760 1800W

Voltage	230V- 50Hz
Rotation speed	4200min ⁻¹
Max. capacity	Depth: 70mm Width: 155mm
Cutting angle	90° - 45°
Table rotation	90° - 45° (mitre saw)
Blade size	Ø255x30mm
Table size	540x500mm
Cable	3m
Features	<ul style="list-style-type: none"> • Convertible duo-action cutting Mitre saw & table saw • Aluminum alloy table top panel • Wheels for easy transport • Adjustable leg for stabilisation • Electric brake & switch
Included	<ul style="list-style-type: none"> • 1x TCT saw blade 80T • 1x dust bag 1x dust adaptor • 1x adjustable clamp for mitre saw • 1x triangular rule for mitre saw • 1x push stick • 1x angle guide for table saw • 1x side fence for table saw • 1x nylon accessories storage bag



VARIABLE ANGLE GUIDE



MAX. CUTTING CAPACITY TABLE SAW
90°: 70mm / 45°: 50mm

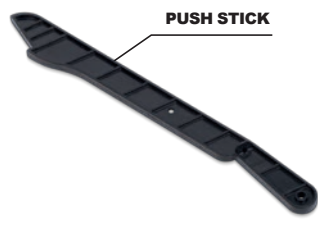

PUSH STICK



MAX. CUTTING CAPACITY MITRE SAW
90° x 90°: 70x155mm
45° x 90°: 40x155mm



MAX. CUTTING CAP. MITRE SAW - BEVEL
90° x 45°: 70x105mm
45° x 45°: 40x105mm

POWX221

Table saw

TAFELZAAG // SCIE À TABLE // TISCHKREISSÄGE // SIERRA DE MESA



POWX221
1500W

Voltage	230-240V~ 50Hz
Rotation speed	4500min ⁻¹
Max. capacity	90°: 80mm / 45°: 55mm
Cutting angle	90° - 45°
Blade size	Ø254x30mm
Table size	638x430mm + Extensions L/R: 638x150mm + Extensions back: 430x180mm Height: 90cm
Size	870x730x1060mm (exterior)
Cable	3m
Features	<ul style="list-style-type: none"> • Steel stamped table • Blade tilting range 90°-45° • Extendable table • Fixes table stand + rubber feet • Dust extraction outlet
Included	<ul style="list-style-type: none"> • 1x TCT saw blade 40T • 3x table extension • 1x dust extraction outlet (Ø40mm) • 1x fixed table stand + rubber feet • 1x side fence with quick clamp • 1x variable angle guide • 1x push stick



5 400338 043079 >



BLADE TILTING RANGE: 90°-45°



REMOVABLE TABLE EXTENSIONS
LEFT/RIGHT: 638x150mm
BACK: 818x180mm



DUST EXTRACTION OUTLET Ø40mm



POWX180

Band saw

BANDZAAG // SCIE À RUBAN // BANDSÄGE // SIERRA DE BANDA



POWX180 350W

Voltage	230V- 50Hz
Max. capacity	Depth: 80mm Width: 190mm
Table tilt	90 - 45°
Blade size	1425x6.25mm - 6TPI
Table size	300x300mm
Cable	2m
Features	<ul style="list-style-type: none"> • Table tilting range 90°-45° • Dust extractor
Included	<ul style="list-style-type: none"> • 1x installed saw blade • 1x variable angle guide with scale • 1x side fence quick clamp • 1x push stick



VARIABLE ANGLE GUIDE



PARALLEL QUICK CLAMP GUIDE/STOP

SPARE SAW BANDS

POWX180A

Size: 1425x6.25mm - 6TPI

For use with: POWX180



POWX180B

Size: 1425x9.53mm - 6TPI

For use with: POWX180



POWX190

Scroll saw

FIGUURZAAGMACHINE // SCIE À CHANTOURNER // DEKUPIERSÄGE // SIERRA MARQUETERÍA

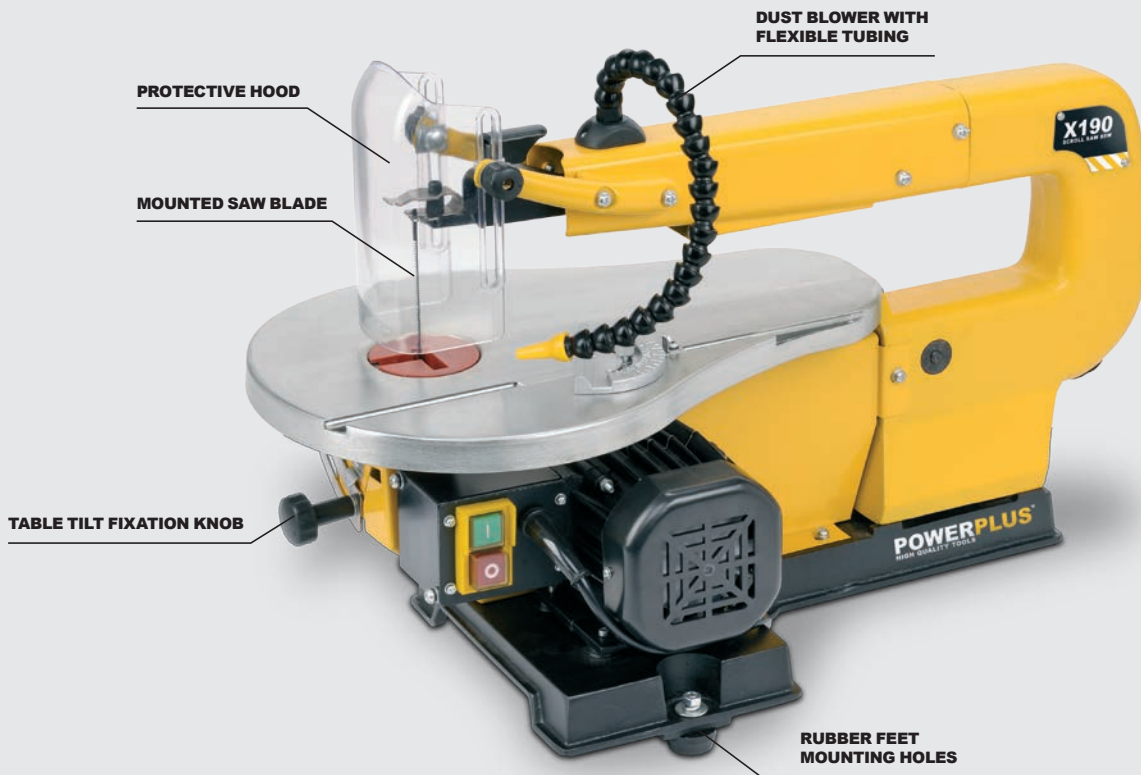

POWX190
85W

Voltage	230V- 50Hz
Max. capacity	Depth: 50mm Width: 410mm
Rotation speed	1440min ⁻¹
Table tilt	0 - 45°
Blade size	133x2.6mm - 24TPI
Table size	375x250mm
Cable	2m
Features	<ul style="list-style-type: none"> • Table tilting range 0°-45° • Dust blower with flexible tubing
Included	<ul style="list-style-type: none"> • 1x mounted saw blade • 3x rubber feet • 1x variable mitre guide



TABLE TILT 0° - 45°

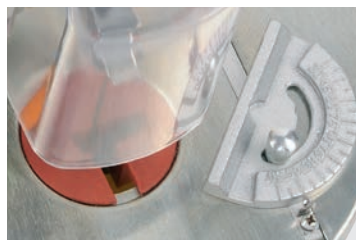

VARIABLE ANGLE GUIDE

SPARE SAW BLADES

POWX190A - 10pcs

Size: 133x2.6mm

Including: 2x 9TPI
3x 15TPI
3x 18TPI
2x 24TPI

For use with: POWX190











POWX230, POWX240 & POWX242

Tile cutters

TEGELSNIDDERS // COUPE-CARRELAGES // FLIESENSCHNEIDER // CORTADORAS AZULEJOS



	 POWX230 750W	 POWX240 600W	 POWX242 1100W
Voltage	230V- 50Hz	230-240V- 50Hz	230V- 50Hz
Rotation speed	2800min ⁻¹	3000min ⁻¹	3000min ⁻¹
Max. capacity	90°: 34mm / 45°: 22mm	90°: 25mm / 45°: 15mm	90°: 60mm / 45°: 48mm
Max. cutting length	/	400mm	600mm
Table tilt	0° - 45°	0° - 45°	0° - 45°
Blade size	Ø180x22.2mm	Ø180x25.4mm	Ø250x25.4mm
Table size	420x380mm	500x385mm	760x510mm
Cable	2m	2m	2m
Features	<ul style="list-style-type: none"> • Chrome plated table with parallel quick clamp fence and variable angle guide • Water reservoir • PRCD: Protective residual current device 	<ul style="list-style-type: none"> • High precision laser (battery incl.) • Soft start • Heavy duty chrome plated table with rail fence and variable angle guide • Water reservoir with cooling water pump • PRCD: protective residual current device 	<ul style="list-style-type: none"> • High precision laser (battery incl.) • Soft start • Heavy duty chrome plated table with rail fence and variable angle guide • Water reservoir with cooling water pump • PRCD: protective residual current device
Included	<ul style="list-style-type: none"> • 1x cutting disc • 1x variable angle guide • 1x parallel quick fence 	<ul style="list-style-type: none"> • 1x cutting disc • 1x variable angle guide • 1x rail fence • 2x AAA battery • 1x stand 	<ul style="list-style-type: none"> • 1x cutting disc • 1x variable angle guide • 1x rail fence • 2x AAA battery • 1x stand
	 5 400338 038655 >	 5 400338 038648 >	 5 400338 038679 >
			



Woodworking

Planer

SCHAAF MACHINE
RABOT
ELEKTROHOBEL
CEPILLO

55

Thickness planer

VANDIKTEBANK
RABOT STATIONNAIRE
DICKENHOBEL
CEPILLADORA DE ESPESOR

56

Jointer planer

VLAK- & VANDIKTEBANK
RABOT DEGAUCHISSEUSE
ABRICHT- UND DICKENHOBEL
CEPILLADORA ALISADORA

57

Routers

BOVENFREZEN
DÉFONCEUSES
OBERFRÄSEN
FRESADORAS

58

Biscuit jointer

LAMELLENFREES
FRAISEUSE À LAMELLES
FLACHDÜBELFRÄSE
FRESADORA DE ENGALLETAR MADERA

59



POWX1110

Planer

SCHAAFMACHINE // RABOT // ELEKTROHOBEL // CEPILLO



POWERPLUS
HIGH QUALITY TOOLS



POWX1110 900W + BMC

Voltage	230-240V~ 50Hz
Rotation speed	0-16000min ⁻¹
Planing width	82mm
Planing depth	0-3mm
Cable	3m

Features	<ul style="list-style-type: none"> • Left/right dust extraction • Blade protection function • Planing depth adjustable knob • Depth guide • Side guide • Soft touch • Soft grip
----------	--

Included	<ul style="list-style-type: none"> • 1x side guide • 1x dust bag • 1x BMC
----------	--



DEPTH GUIDE



LEFT/RIGHT DUST EXTRACTION + DUST BAG

POWX200

Thickness planer

VANDIKTEBANK // RABOT STATIONNAIRE // DICKENHOBEL // CEPILLADORA DE ESPESOR



POWX200
1800W

Voltage	230V- 50Hz
Rotation speed	9000min ⁻¹
Cuts/min	18000
Feeding speed	4-6m/min
Max. capacity	Min. planing length: 140mm Max. planing width: 330mm Max. planing depth/height: 5-150mm
Cable	2m
Features	<ul style="list-style-type: none"> • Digital display • Height adjusting wheel max. 150mm • Height locking lever • Fixed table stand + rubber feet • Large pull-out in feed and out feed extensions
Included	<ul style="list-style-type: none"> • 1x fixed table stand + rubber feet • 1x dust extractor



LARGE PULL-OUT IN FEED AND OUT FEED EXTENSIONS



DIGITAL DISPLAY (FOR DEPTH OF CUT ADJUSTMENT)

SPARE KNIFE SET

POWX200A - 2pcs

Blade size: Ø332x18.2x3.2mm

For use with: POWX200



POWX204

Jointer planer

VLAK- & VANDIKTEBANK // RABOT DEGAUCHISSEUSE // ABRICHT- UND DICKENHOBEL // CEPILLADORA ALISADORA

POWERPLUS
HIGH QUALITY TOOLS



POWX204 1500W

Voltage	230-240V~ 50Hz
Rotation speed	9000min ⁻¹
Cuts/min	18000
Feeding speed	6m/min
Max. capacity	Max. planing width: 204mm Max. planing depth jointer: 0-3mm Max. planing depth planer: 0-2mm Max. planing depth/height: 5-120mm
Planer table size	270 x 204mm
Jointer table size	740x213mm
Cable	2m
Features	<ul style="list-style-type: none"> • Convertible duo-action jointer & planer mode • Height locking lever • Height adjusting wheel max. 150mm • Fixed table stand + rubber feet • Emergency stop • Feed extensions
Included	<ul style="list-style-type: none"> • 1x wood pusher • 1x parallel guide • 1x blade guard • 1x dust adaptor



JOINTER MODE



PLANER MODE



BLADE PROTECTOR + DUST EXTRACTOR FOR PLANER MODE & JOINTER MODE

SPARE KNIFE SET

POWX204A - 2pcs

Blade size: Ø210x16.5x1.5mm

For use with: POWX204



POWX0910 & POWX093

Routers

BOVENFREZEN // DÉFONCEUSES // OBERFRÄSEN // FRESADORAS



VARIABLE SPEED

FINGERTIP DEPTH ADJUSTMENT



DUST PROOF SLEEVES

SOLID GUIDE FENCE

SOLID GUIDE FENCE WITH DISTANCE SCALE

DUST EXTRACTOR



POWX0910
1200W + BMC



POWX093
1500W + BMC

Voltage	230V~ 50Hz	230-240V~ 50Hz
Rotation speed	11000-30000min ⁻¹	6000-26000min ⁻¹ (7 speed)
Router depth	2x Ø150mm DRY	50mm
Collet	6 / 8mm - 1/4"	8 / 12mm - 1/2"
Cable	3m	3m
Features	<ul style="list-style-type: none"> • Solid metal base • Dust proof sleeves for sliding post • Fingertip depth adjustment • Variable speed • Soft grip • Soft touch 	<ul style="list-style-type: none"> • Solid metal base • Soft start • Fingertip depth adjustment • Variable speed • soft grip non-slip handles + integrated switch
Included	<ul style="list-style-type: none"> • 6x router bit Ø8mm • 1x guide fence • 1x BMC 	<ul style="list-style-type: none"> • 12x router bit Ø8-12mm • 1x guide fence with distance scale • 1x BMC

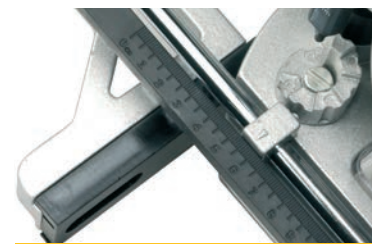

METAL PARALLEL GUIDE FENCE WITH DISTANCE SCALE (POWX093)

ROUTER BITS IN ALU CASE

POWX091S15 - 15pcs - Ø8mm

For use with:
POWX091 / POWX0910 / POWX093



POWX093S12 - 12pcs - Ø12mm

For use with: POWX093



POWX131

Biscuit jointer

LAMELLENFREES // FRAISEUSE À LAMELLES // FLACHDÜBELFRÄSE // FRESADORA DE ENGALLETAR MADERA



FOR BISCUITS 0 - 10 - 20
(NOT INCLUDED)

 <p>POWX131 900W</p>	
Voltage	230V~ 50Hz
Rotation speed	10800min ⁻¹
Blade size	Ø100x22mm
Cutting depth	3mm - 10mm - 12.3mm - 19mm
Cutting height	0-30mm
Cable	3m
Features	<ul style="list-style-type: none"> Suitable biscuits: sizes 0 - 10 - 20 Fence angle adjustment: 0-90° / 90°-135°
Included	<ul style="list-style-type: none"> 1x TCT blade 6T 1x dust bag 1x set carbon brushes 1x BMC
 <p>5 400338 025167 ></p>	

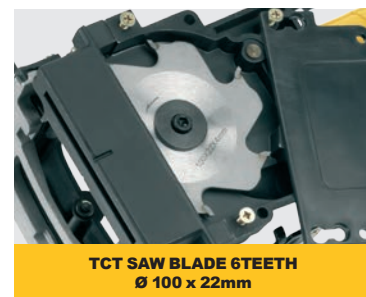

SPARE SAW BLADE	
POWX131A	
Blade size: Ø100x22x3.8mm 6T	
For use with: POWX131	
 <p>5 400338 025358 ></p>	

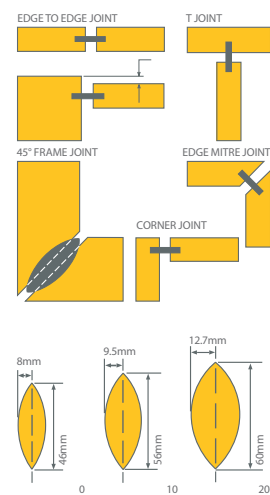

Specials

Power stations, Cleaners & deco

Power stations

Power station (4-in1) **61**

ENERGIESTATION
ALIMENTATION ÉLECTRIQUE
SCHNELLSTARTSYTEM
ARRANCADOR

Power generators **62**

GENERATOREN
GROUPE ÉLECTROGÈNES
STROMERZEUGER
GENERADORES

Cleaners

Vacuum cleaners **63-65**

STOFZUIGERS
ASPIRATEURS
STAUBSAUGER
ASPIRADORES

Ash cleaners **66**

ASZUIGERS
VIDE-CENDRES
ASCHESAUGER
ASPIRADORES DE CENIZAS

Deco

Heat gun **67**

HETELUCHTPISTOOL
DÉCAPEUR
HEIBLUFTPISTOLE
DECAPADOR

Paint spray guns **68**

VERFPISTOLEN
PISTOLETS PULVÉRISATEURS DE PEINTURE
FARBSPRITZPISTOLEN
PISTOLAS PULVERIZADORAS DE PINTURA

Paint spray stations **69**

VERFSTATIONS
STATIONS DE PULVÉRISATION DE PEINTURE
FEINSPRÜHGERÄTE
ESTACIONES PULVERIZADORAS DE PINTURA

Wallpaper stripper **70**

BEHANGAFSTOMER
DÉCOLLEUSE PAPIER PEINT
TAPETEN DAMPFLÖSEGERÄT
DECAPADOR PARA PAPEL PINTADO



Portable 4-in-1 POWX410 Power station

ENERGIESTATION // ALIMENTATION ÉLECTRIQUE // SCHNELLSTARTSYSTEM // ARRANCADOR

CHARGING INDICATOR
LIGHT & AC CHARGING
ADAPTOR INPUT

2x EMERGENCY
LIGHT

POWER OUTPUT

2x WORKLIGHT



JUMP START

AIR PRESSURE
GAUGE

COMPRESSOR
INFLATING HOSE
WITH 3 VALVES

ACCESSORY
COMPARTMENT

4x REPLACEMENT LIGHTS
2x AUTO FUSE



**OIL
FREE**



**POWX410
12V - 900Amp**

Functions	Jump start Compressor Power output Emergency light
Start power	900Amp (peak)
Rotation speed	3400min ⁻¹
Power supply	3x 12V (max. 6Amp)
Light	2x emergency light 3W 2x worklight 3W
Operating pressure	250psi / 17bar
Features	<ul style="list-style-type: none"> Maintenance free 12V Battery 17Ah LED battery indication Start cables Manometer Pressure gauge
Included	<ul style="list-style-type: none"> 1x AC/DC adaptor 230V~ 50Hz 4x light 1x Inflating hose with 3 valves 2x auto fuse



HEAVY-DUTY PLASTIC HANDLES WITH
METAL SAW-TOOTH CLAMPS



3x 12V DC OUTPUT WITH OVERLOAD
PROTECTION (CIGARET LIGHTER TYPE)



AC ADAPTOR & DC ADAPTOR
FOR RECHARGEABLE BATTERY



POWX510, POWX513 & POWX516







Power generators

GENERATOREN • GROUPES ÉLECTROGÈNES • STROMERZEUGER • GENERADORES



ECO FRIENDLY
less CO₂ emission



	 POWX510 2200W	 POWX513 3000W	 POWX516 5500W
Voltage	230V~ 50Hz	230V~ 50Hz	230V~ 50Hz
Fuel tank capacity	15 litres (unleaded EURO 95/98)	15 litres (unleaded EURO 95/98)	25 litres (unleaded EURO 95/98)
Oil tank capacity	0.6 litres	0.6 litres	1.1 litres
Rated continuous operation	11 hours	9 hours	7.5 hours
Displacement	196cc	208cc	389cc
Features	<ul style="list-style-type: none"> • 2x AC socket 230V~ 50Hz • Choke lever • Petrol level display • Volt meter • Air filter • DC circuit breaker • 1x transport handle 	<ul style="list-style-type: none"> • 2x AC socket 230V~ 50Hz • Choke lever • Petrol level display • Volt meter • Air filter • DC circuit breaker • 1x transport handle 	<ul style="list-style-type: none"> • 3x AC socket 230V~ 50Hz • Choke lever • Petrol level display • Volt meter • Air filter • DC circuit breaker • 2x transport handle
Included	<ul style="list-style-type: none"> • 1x spark plug wrench • 2x wheels (Ø200mm) • 1x funnel • 1x tube 	<ul style="list-style-type: none"> • 1x spark plug wrench • 2x wheels (Ø200mm) • 1x funnel • 1x tube 	<ul style="list-style-type: none"> • 1x spark plug wrench • 2x wheels (Ø250mm) • 1x funnel • 1x tube
	 5 400338 057137 >	 5 400338 057144 >	 5 400338 057151 >



POWX320 & POWX321

Vacuum cleaners

STOFZUIGERS // ASPIRATEURS // STAUBSAUGER // ASPIRADORES



POWERPLUS
HIGH QUALITY TOOLS



WET DRY FUNCTION



POWX320
800W - 10L



POWX321
1000W - 18L

Voltage	220-240V~ 50Hz	220-240V~ 50Hz
Tank capacity	10L	18L
Suction power	> 14 Kpa	> 14 Kpa
Cable	1.9m	3.5m
Use	WET / DRY	WET / DRY

Features	<ul style="list-style-type: none"> • Can be used with or without dust bag • New advanced filter system • Handle with air valve 	<ul style="list-style-type: none"> • Can be used with or without dust bag • New advanced filter system • Handle with air valve
----------	---	---

Included	<ul style="list-style-type: none"> • 1x wet/dry floor brush • 1x 2-in-1 brush • 3x plastic tube • 1x 1.5m soft tube • 1x paper dust bag • 4x wheels • 1x HEPA filter 	<ul style="list-style-type: none"> • 1x wet/dry floor brush • 1x 2-in-1 brush • 3x plastic tube • 1x 2.5m soft tube • 1x paper dust bag • 4x wheels • 1x HEPA filter
----------	---	---



NEW ADVANCED FILTER SYSTEM

SPARE DUST BAGS

POWX320A - 10L - 3 PCS

For use with: POWX320



POWX321A - 18L - 3 PCS

For use with: POWX321



POWX323

Vacuum cleaner

STOFZUIGER // ASPIRATEUR // STAUBSAUGER // ASPIRADOR



 POWX323 1200W	
Voltage	220-240V~ 50Hz
Tank capacity	30L
Suction power	> 15 Kpa
Cable	3.5m
Use	WET / DRY
Features	<ul style="list-style-type: none"> • Auto start system / electric tool • Can be used with or without dust bag • Stainless steel tank • New advanced filter system • Additional handle with soft grip
Included	<ul style="list-style-type: none"> • 1x wet/dry floor brush • 1x 2-in-1 brush • 1x stainless steel telescopic tube • 1x 3.5m soft tube • 3x paper dust bag • 1x Hepa filter • 1x additional handle • 4x wheels
 5 400338 056543 >	
	



SPARE DUST BAGS

POWX323A - 30L - 3 PCS

For use with: POWX323

 5 400338 056581 >

POWX325

Vacuum cleaner

STOFZUIGER // ASPIRATEUR // STAUBSAUGER // ASPIRADOR



POWERPLUS
HIGH QUALITY TOOLS

SOFT TUBE 3.5m



NEW ADVANCED FILTER SYSTEM

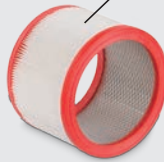

MOUNTED ON METAL TROLLEY

ADDITIONAL HANDLE

STAINLESS STEEL TUBE



CLOTH FILTER

2 ENGINES

WET FLOOR BRUSH

DRY FLOOR BRUSH

ROUND BRUSH

CREVICE NOZZLE

STAINLESS STEEL TANK



POWX325
2x 1200W

Voltage	220-240V~ 50Hz
Tank capacity	60L
Suction power	> 16 Kpa
Cable	5.6m
Use	WET / DRY
Features	<ul style="list-style-type: none"> • 2 engines • Drain device • Use without dust bag • Stainless steel tank • New advanced filter system • Handle with air valve • Additional handle with soft grip
Included	<ul style="list-style-type: none"> • 1x wet floor brush • 1x dry floor brush • 1x round brush • 1x crevice nozzle • 1x stainless steel tube • 1x 3.5m soft tube • 1x HEPA filter • 1x cloth filter • 1x metal trolley

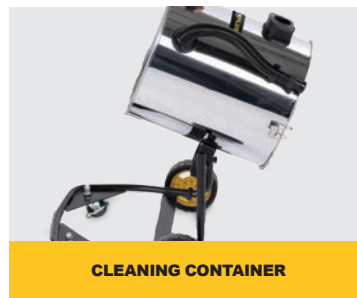

POWX302, POWX305 & POWX308

Ash cleaners

ASZUIGERS // VIDE-CENDRES // ASCHESAUGER // ASPIRADORES DE CENIZAS



	 POWX302 20L	 POWX305 1000W - 20L	 POWX308 1200W - 20L
Voltage	- must be used with a vacuum cleaner	220-240V~ 50Hz	220-240V~ 50Hz
Tank capacity	20 litres	20 litres	20 litres
Tank size	Ø29.5cm H31cm	Ø29.5cm H31cm	Ø29.5cm H31cm
Max. temperature ashes	60°C	60°C	60°C
Cable	-	1.5m	3.5m
Features	<ul style="list-style-type: none"> • Strong and durable tank • Can be used with any standard vacuum cleaner • Ideal for cleaning sawdust, BBQ coals or fireplace ashes (max. 60°C) without damaging your cleaner 	<ul style="list-style-type: none"> • Strong and durable tank • Red filter indicator • With blow function • Ideal for cleaning sawdust, BBQ coals or fireplace ashes (max. 60°C) without damaging your cleaner 	<ul style="list-style-type: none"> • Strong and durable tank • Red filter indicator • With blow function • 4 wheels • Ideal for cleaning sawdust, BBQ coals or fireplace ashes (max. 60°C) without damaging your cleaner
Included	<ul style="list-style-type: none"> • 1x Ø4.5x90cm suction hose + 5cm plastic connector • 1x aluminium nozzle (Ø3.85x20cm) • 1x washable filter 	<ul style="list-style-type: none"> • 1x Ø3.85x120cm suction hose + 5cm plastic connector • 1x aluminium nozzle (Ø3.4x23cm) • 1x double layer filter 	<ul style="list-style-type: none"> • 1x Ø3.85x120cm suction hose + 5cm plastic connector • 1x aluminium nozzle (Ø3.4x23cm) • 1x double layer filter • 1x floor brush • 1x dusting brush • 2x plastic tube • 4x wheels

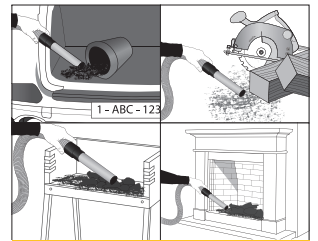

IDEAL FOR CLEANING SAWDUST, BBQ COALS OR FIREPLACE ASHES



SPARE DOUBLE LAYER FILTER

POWX305B

For use with: POWX305 & POWX308



POWX1020

Heat gun

HETELUCHTPISTOOL // DÉCAPEUR // HEIßLUFTPISTOLE // DECAPADOR



POWERPLUS
HIGH QUALITY TOOLS



POWX1020
2000W + BMC

Voltage	230V- 50Hz
Adjustable temperature	60-600°C
Air speed	350-550 l/m
Cable	3m
Features	<ul style="list-style-type: none"> • Cool zone • Constant heat control • Digital display with temperature indication • Thermal protect switch • Soft touch • Soft grip • D-handle
Included	<ul style="list-style-type: none"> • 1x high quality stainless steel scraper



DIGITAL DISPLAY WITH TEMPERATURE INDICATION



THERMAL PROTECTION



POWX350 & POWX353

Paint spray guns

VERFPISTOLEN // PISTOLETS PULVÉRISATEURS DE PEINTURE // FARBSPRITZPISTOLEN // PISTOLAS PULVERIZADORAS DE PINTURA



	 POWX350 120W	 POWX353 400W
Voltage	220-230V- 50Hz	230-240V- 50Hz
Tank capacity	800ml	900ml
Flow speed	0-320g/min	0-550g/min
Nozzle diameter	Ø0.8mm	Ø1.5-1.8-2.5mm
Cable	2m	3m
Features	<ul style="list-style-type: none"> Multi purpose spray gun for every surface Adjustable paint flow control 	<ul style="list-style-type: none"> HVLP System Nice flow 3 different spray patterns: vertical – horizontal – round Silent turbine at the back of the machine Adjustable paint flow control
Included	<ul style="list-style-type: none"> 1x viscosity measuring cup 1x cleaning pin 1x spare nozzle including valve 1x flexible nozzle extension 170mm 	<ul style="list-style-type: none"> 1x viscosity measuring cup 3x nozzles: 1.5mm/1.8mm/2.5mm (2.5mm is assembled)
	 5 400338 052682 >	 5 400338 053887 >

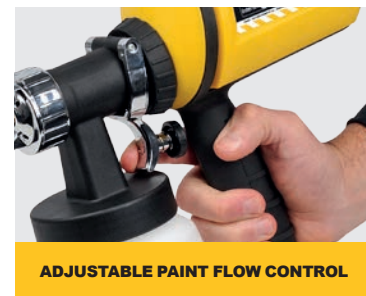

HVLP High volume, Low pressure

POWX355 & POWX357

Paint spray stations

VERFSTATIONS // STATION DE PULVÉRISATION DE PEINTURE // FEINSPRÜHGERÄTE // ESTACIONES PULVERIZADORAS DE PINTURA



* **HORIZONTAL, VERTICAL & ROUND SPRAY PATTERNS**



		
	POWX355 350W	POWX357 900W
Voltage	220-240V - 50Hz	220-240V - 50Hz
Tank capacity	700ml	700ml
Flow speed	0-550g/min	0-800g/min
Nozzle diameter	Ø2.6mm	Ø2.6mm
Cable	2m	2m
Features	<ul style="list-style-type: none"> • HVLP system • Multi purpose spray nozzle • 3 different spray patterns: vertical – horizontal – round • Adjustable paint flow control • Long air hose 	<ul style="list-style-type: none"> • HVLP system • Multi purpose spray nozzle • 3 different spray patterns: vertical – horizontal – round • Adjustable paint flow control • Extra long air hose
Included	<ul style="list-style-type: none"> • 1x viscosity measuring cup • 1x carrying belt • 1x adjustable nozzle • 1x long air hose 1.8m 	<ul style="list-style-type: none"> • 1x viscosity measuring cup • 1x adjustable nozzle • 1x extra long air hose 3m
	 5 400338 052699 >	 5 400338 052675 >
	HVLP High volume, Low presure	HVLP High volume, Low presure



CARRYING BELT (POWX355)



MULTI-PURPOSE SPRAY NOZZLE FOR EVERY SURFACE

HVLP

High volume, Low pressure

- **reduced** overspray
- **reduced** blowback
- **fast and even** coverage
- **no** waste of paint

POWX340

Wallpaper stripper

BEHANGAFSTOMER // DÉCOLLEUSE PAPIER PEINT // TAPETEN DAMPFLOESEGERÄT // DECAPADOR PARA PAPEL PINTADO



POWX340
2200W

Voltage	220-240V~ 50Hz
Work time	75min
Steam plate size	305x200mm
Steam tube length	3m
Cable	1.5m
Features	<ul style="list-style-type: none"> • Refill water tank after 75min with 4.5 litre water • Safety valve
Included	<ul style="list-style-type: none"> • 1x steam tube 3m • 1x steam plate



Specials

Various

Concrete/paint mixers

BETON-/VERFMENGENS
MÉLANGEURS À BÉTON/PEINTURE
RÜHRWERK
MEZCLADORES ELÉCTRICOS

72-73

Hot glue gun

HETELIJMPISTOOL
PISTOLET À COLLE CHAUDE
HEIßKLEBEPISTOLE
PISTOLA DE COLA CALIENTE

74

Soldering irons & gun

SOLDEERBOUTEN EN -PISTOOL
FERS ET PISTOLET À SOUDER
LÖTKOLBEN UND -PISTOLE
SOLDADURES Y PISTOLA DE SOLDADURA

75

Nail/staple gun

NAGEL- / NIETAPPARAAT
AGRAFEUSE / CLOUEUSE
KOMBI TACKER
GRAPADORA / CLAVADORA

76

Self-levelling laser level

ZELFNIVELLERENDE LASERWATERPAS
LASER POINTEUR À NIVELLEMENT AUTOMATIQUE
SELBSTNIVELLIERENDER LINIENLASER
NIVEL LÁSER AUTONIVELANTE

78











POWX083 & POWX084

Concrete/paint mixers

BETON-/VERFMENGENS // MÉLANGEURS À BÉTON/PEINTURE // RÜHRWERK // MEZCLADORES ELÉCTRICOS



	 POWX083 1220W	 POWX084 1600W
Voltage	230-240V - 50Hz	230-240V - 50Hz
Rotation speed	180-460min ⁻¹ / 300-700min ⁻¹	180-460min ⁻¹ / 300-700min ⁻¹
Size agitator	Ø120mm	Ø160mm
Cable	3m	3m
Features	<ul style="list-style-type: none"> • 2 speed • Speed controller • constant speed control • Soft start • Lock-on button • Spindle thread: M14 • Soft grip 	<ul style="list-style-type: none"> • 2 speed • Speed controller • Constant speed control • Soft start • Lock-on button • Spindle thread: M14 • Soft grip
Included	<ul style="list-style-type: none"> • 1x mixing paddle Ø120mm • 2x spanner 	<ul style="list-style-type: none"> • 1x mixing paddle Ø160mm • 2x spanner
	 5 400338 066269 >	 5 400338 066283 >
	 	 



POWX088

Double mixer

DUBBELE MENGER // MELANGEUR DOUBLE // DOPPEL RÜHRWERK // MEZCLADOR DOBLE



 <p>POWX088 1600W</p>	
Voltage	230V~ 50Hz
Rotation speed	100-420min ⁻¹ / 150-600min ⁻¹
Size agitator	2x Ø120mm
Cable	3m
Features	<ul style="list-style-type: none"> • 2 speed • Speed controller • Constant speed control • High performance paddles • Robust gear box with powerful high torque motor • Lock-on button • Soft start • SDS HEX connection • Soft grip
Included	<ul style="list-style-type: none"> • 2x mixing paddle Ø120 x 550mm with hex shaft 13mm
 <p>5 400338 057168 ></p>	
 	

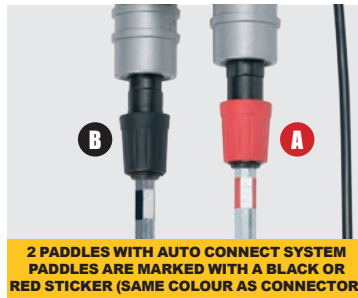

POWX145

Hot glue gun

HETELIJMPISTOOL // PISTOLET À COLLE CHAUDE // HEIßKLEBEPISTOLE // PISTOLA DE COLA CALIENTE



POWX145
35W + BMC

Voltage	230V~ 50Hz
Glueing capacity	14-16g/min
Warming time	3-5 minutes

Features

- Power supply station for working without a mains cable

Included

- 6x glue stick
- 1x spanner
- 2x round head nozzle
- 1x precision nozzle



CAN BE USED WITH LOADING STATION BUT ALSO WITH A MAINS CABLE



3 NOZZLES (2x ROUND & 1x FLAT)









ROTATABLE FOOTSTAND

POWX1380, 1381 & 1385

Soldering irons & gun

SOLDEERBOUTEN EN -PISTOOL // FERS ET PISTOLET À SOUDER // LÖTKOLBEN UND -PISTOLE // SOLDADURES Y PISTOLA DE SOLDADURA



			
	POWX1380 30W	POWX1381 60W	POWX1385 100W
Voltage	230-240V~ 50Hz	220-240V~ 50Hz	220-240V~ 50Hz
Features	<ul style="list-style-type: none"> • Soft grip 	<ul style="list-style-type: none"> • Soft grip 	<ul style="list-style-type: none"> • Soft grip • LED worklight
Included	<ul style="list-style-type: none"> • 1x iron stand • 1x soldering needle 	<ul style="list-style-type: none"> • 1x iron stand • 1x soldering needle 	<ul style="list-style-type: none"> • 2x soldering tip
			



COMFORT USE



LED WORKLIGHT

POWX137

Nail/staple gun

NAGEL-/NIETAPPARAAT // AGRAFEUSE/CLOUEUSE // KOMBI TACKER // GRAPADORA/CLAVADORA

ADJUSTABLE
IMPACT FORCE

SOFT GRIP

BATTERY

MAX. LENGTH:
NAILS: 15mm
STAPLES: 6-14mm
WIDTH: 11.2mm

SAFETY NOSE

CHARGER BASE



POWX137
4.8V + BMC

Battery capacity	1300mAh Ni-Mh
Capacity magazine	Up to 100 nails/staples
Firing capacity	30 nails/staples per minute
Charging time	5-6 hours
Autonomy	Up to 500 shots/battery
Max. length nails	15mm
Staple length	6-14mm
Staple width	11.2mm
Features	<ul style="list-style-type: none"> • Easy nails/staples replacement • Soft grip
Included	<ul style="list-style-type: none"> • 1x charger + charger base • 1x battery 1300mAh Ni-Mh • 1000x staple 14mm • 1000x nail 15mm • 1x BMC



EASY NAILS/STAPLES REPLACEMENT

BMC INCLUDED



POWX138

Nail/staple gun

NAGEL-/NIETAPPARAAT // AGRAFEUSE/CLOUEUSE // KOMBI TACKER // GRAPADORA/CLAVADORA



POWX138 + BMC

Voltage	220-240V- 50Hz
Capacity magazine	Up to 100 nails/staples
Firing capacity	20 nails/staples per minute
Max. length nails	32mm
Staple length	16-25mm
Staple width	6mm
Cable	2.5m
Features	<ul style="list-style-type: none"> • Easy nails/staples replacement • Power adjustment wheel • Soft grip
Included	<ul style="list-style-type: none"> • 300x staple 16mm • 200x nail 25mm • 1x BMC



EASY NAILS/STAPLES REPLACEMENT



**POWER ADJUSTMENT WHEEL
LEVEL 1 TO 6**



BMC INCLUDED

POWX720

Self-levelling laser level

ZELFNIVELLERENDE LASERWATERPAS // LASER POINTEUR À NIVELLEMENT AUTOMATIQUE // SELBSTNIVELLIERENDER LINIENLASER // NIVEL LÁSER AUTONIVELANTE



POWX720 Self-leveling

Battery	2x AA batteries 1.5V
Wave length of laser	650mm
Power of laser	≤ 1mW
Selfleveling	Scope: ≤ 6° Speed: ≤ 7sec
Laser class	2
Operative distance	≤ 10m
Spread angle	≤ 90°
Included	<ul style="list-style-type: none">• 1x 360° rotating base• 1x tripod• 1x wall bracket• 2x 1.5V AA battery• 1x BMC

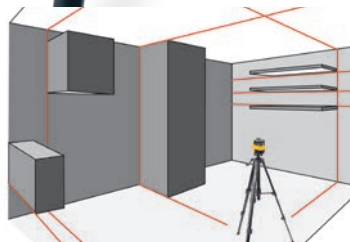

HORIZONTAL, VERTICAL
AND CROSS HAIR



SELF LEVELLING TILL 6° IN 7 SECONDS



Notes

A series of horizontal dotted lines for writing notes.



varo

VIC. VAN ROMPUY nv

JOSEPH VAN INSTRAAAT 9
2500 LIER - BELGIUM
TEL +32 (0)3 292.92.92
FAX +32 (0)3 292.92.72
E-MAIL: INFO@VARO.COM
WWW.VARO.COM

OFFICES:

IBERICA BRICOLAGE S.L. - ESPAÑA
ASIA PACIFIC HONG KONG Ltd / SHANGHAI PRC
AUSTRALIA Pty Ltd / GERMANY GmbH

POWERPLUS[®] **3 YEAR WARRANTY**
HIGH QUALITY TOOLS

© Copyright VARO - Vic. Van Rompuy nv 2014 / Product specifications are subject to change without notice. VARO is not responsible for typographical or photographic errors that may appear in this catalogue. Pictures may vary from the actual products. We reserve the right to make adjustments or corrections due to errors, changing market conditions, product discontinuations, or typographic or photographic errors in advertisements or product descriptions. Item availability and prices are subject to change without notice.

SDS[®] is a registered trademark of Robert Bosch GmbH. / Torx[®] is a registered trademark of Acument Intellectual Properties, LLC.