

**5 YEAR  
WARRANTY**

**POWERPLUS<sup>®</sup> XQ**  
HIGH QUALITY TOOLS

## 5 YEAR WARRANTY

The quality of Powerplus XQ is highlighted by a warranty of no less than 5 years! This unique warranty advantage assures you that you made the right purchase and allows you to fully enjoy the reliability of the Powerplus XQ quality while performing countless jobs for the next 5 years.

## QUALITY & DURABILITY TESTS

All our Powerplus XQ tools are carefully checked and subjected to a strict quality control. Only those Powerplus XQ tools that meet the SGS-CEBEC Quality Performance criteria are accepted by us. Varo has chosen SGS, the world leader in testing and certification, as a permanent partner for the verification of our quality. The SGS-CEBEC Quality Performance program ensures a thorough verification of various aspects such as durability, performance and safety.



**5 YEAR  
WARRANTY**

**QUALITY PERFORMANCE  
TESTED BY**

**SGS**

**CEBEC**



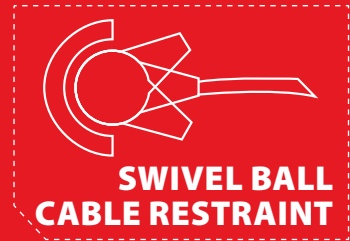

# 4m RUBBER CABLE WITH BALL JOINT

Most of the XQ power tools have a 4 metre rubber cable with ball joint. The ball joint allows your electrical cable to move flexibly, which guarantees the durability of your tool. The connection of your tool with the electrical cable will not be affected by the use: the insulation in the cable will not be damaged by frequent bending and the copper wires inside will not break from stress. The 4 metre cable gives you extra freedom of movement. A supple rubber cable means that it is extremely durable and flexible. In comparison to PVC, rubber is also more resistant to grease, acids etc.



# MAGNESIUM

The main part of the machine housing of most Powerplus XQ tools is made of magnesium. Magnesium is the lightweight metal of the future, extremely strong and durable. **75% lighter** than steel and **35% lighter** than aluminium. The material absorbs energy and thus ensures extra shock absorption.

# INDEX

## **NIMH CORDLESS DRILLS 6**

**POWXQ5231 - POWXQ5234**  
Snoerloze NiMH boormachines // Perceuses sans fil NiMH  
NiMH Akku-Bohrschrauber // Taladros a batería NiMH

## **LI-ION CORDLESS DRILLS 8**

**POWXQ5243 - POWXQ5250**  
Snoerloze Li-Ion boormachines // Perceuses sans fil Li-Ion  
Li-Ion Akku-Bohrschrauber // Taladros a batería Li-Ion

## **MULTI-USE TOOL 10**

**POWXQ5271**  
Multifunctioneel gereedschap // Outil multi-usage  
Multifunktionsgerät // Herramienta multifunción

## **IMPACT DRILLS 12**

**POWXQ5203 - POWXQ5205**  
Klopboormachines // Perceuses à percussion  
Schlagbohrmaschinen // Taladros percutores

## **HAMMER DRILLS 14**

**POWXQ5220 - POWXQ5223 - POWXQ5226**  
Boorhamers // Marteaux perforateurs  
Bohrhammer // Martillos perforadores

## **FINISHING SANDER 17**

**POWXQ5401**  
Vlakschuurmachine // Ponceuse vibrante  
Schwingschleifer // Lijadora orbital

## **BELT SANDER 18**

**POWXQ5406**  
Bandschuurmachine // Ponceuse à bande  
Bandschleifer // Lijadora de banda

## **ELECTRIC PLANER 19**

**POWXQ5502**  
Schaafmachine // Rabot  
Elektrohobel // Cepillo

## **ANGLE GRINDERS 20**

**POWXQ5102 - POWXQ5104 - POWXQ5107**  
Haakse slijpers // Meuleuses d'angle  
Winkelschleifer // Amoladoras angulares

## **JIGSAW 23**

**POWXQ5302**  
Decoupeerzaag // Scie sauteuse  
Stichsäge // Sierra de calar

## **CIRCULAR SAWS 24**

**POWXQ5313 - POWXQ5315**  
Cirkelzagen // Scies circulaires  
Handkreissägen // Sierras circulares

## **MITRE SAW 26**

**POWXQ5330**  
Verstekzaag // Scie à onglet  
Kapp-und Gehrungssäge // Ingletadora

## **TELESCOPIC MITRE SAW 27**

**POWXQ5335**  
Telescopische verstekzaag  
Scie à onglet télescopique  
Teleskopische Kapp-und Gehrungssäge  
Ingletadora telescópica

## **MITRE & TABLE SAW 2-IN-1 28**

**POWXQ5350**  
Verstek- / tafelzaag 2-in-1  
Scie à onglet / scie à table 2-en-1  
Kapp-und Gehrungssäge / Tischkreissäge 2-in-1  
Ingletadora / sierra de mesa 2-en-1

## **TABLE SAW 29**

**POWXQ5360**  
Tafelzaag // Scie à table  
Tischkreissäge // Sierra de mesa

## **TILE CUTTER 30**

**POWXQ5320**  
Tegelsnijder // Coupe-carrelage  
Fliesenschneidmaschine // Cortador azulejos

## **CUT-OFF SAW FOR METAL 31**

**POWXQ5390**  
Metaalsnijder // Tronçonneuse pour métal  
Metall-trennmaschine // Tronzadora de metal

## **HEAT GUNS 32**

**POWXQ6104 - POWXQ6110**  
Heteluchtpistolen // Décapeurs  
Heißluftpistolen // Decapadores

## **COMPRESSORS 34**

**POWXQ8105 - POWXQ8125**  
Compressoren // Compresseurs  
Kompresoren // Compresores

## **JAWZILLA CLAMPING STAND 36**

**POWXQ9100**  
Jawzilla spanbok // Support de serrage Jawzilla  
Spannbok Jawzilla // Caballete de sujeción Jawzilla

## **SUPPORT STANDS FOR MITRE & TABLE SAWS 37**

**POWXQ53300T - POWXQ53600T**  
Onderstellen voor verstek-en tafelzagen  
Supports pour scies à onglet et à table  
Ständer für Gehrungs-und Tischkreissäge  
Soportes para ingletadoras y sierras de mesa

## **MULTITOOL 15-IN-1 38**

**POWXQ9756**  
Multigereedschap // Outil multifonctions  
Multitool // Herramienta multiusos

## **RETRACTABLE UTILITY KNIFE 38**

**POWXQ9753**  
Hobbymes // Cutter universel  
Universal Messer // Cuchilla

## **SCREWDRIVER SET 30pcs 39**

**POWXQ9720**  
30-dlg schroevendraaierset // Jeu de tournevis 30pcs  
30-tlg Schraubendreher Satz // Set destornilladores 30pcs

## **METAL BOX 39**

**POWXQ9255**  
Metalen koffer // Coffre en métal  
Metall Kasten // Caja de metal

# CORDLESS DRILL NiMH 14.4V

**POWXQ5231**



**5 YEAR WARRANTY**

25+2 torque settings

2 speed function switch

Forward & reverse rotation

Soft grip

1 extra battery pack

Auxiliary handle

RATED VOLTAGE	14.4V
2x BATTERY	NiMH 2000mAh
2 SPEED	0-450/0-1700min <sup>-1</sup>
KEYLESS JACOBS CHUCK	13mm
CHARGING TIME	1h
MAX. TORQUE	35Nm
TORQUE SETTINGS	25+2

## FEATURES

- 2 BATTERIES
- IMPACT FUNCTION
- AUXILIARY HANDLE



Including BMC

1h charger



■ **XQ5231B**

Spare battery 14.4V NiMH 2000mAh



# CORDLESS DRILL NiMH 18V

**POWXQ5234**



5 400338 041877 >



**5 YEAR WARRANTY**

RATED VOLTAGE	18V
2x BATTERY	NiMH 2500mAh
2 SPEED	0-470/0-1800min <sup>-1</sup>
KEYLESS JACOBS CHUCK	13mm
CHARGING TIME	1h
MAX. TORQUE	40Nm
TORQUE SETTINGS	25+2



Including BMC

1h charger



**■ XQ5234B**  
Spare battery 18V  
NiMH 2500mAh



5 400338 041891 >

## FEATURES

- 2 BATTERIES
- IMPACT FUNCTION
- AUXILIARY HANDLE

# CORDLESS DRILL LI-ION 12V

**POWXQ5243**



**5 YEAR WARRANTY**



Built-in bit holder



RATED VOLTAGE	12V
2x BATTERY	Li-Ion 1300mAh
2 SPEED	0-350/0-1200min <sup>-1</sup>
KEYLESS SANOU CHUCK	10mm
CHARGING TIME	1h
MAX. TORQUE	30Nm
TORQUE SETTINGS	11+1



Including BMC

## FEATURES

- 2 LI-ION BATTERIES
- LED LIGHT
- BUILT-IN BIT HOLDER
- KEYLESS CHUCK WITH QUICK SDS-TYPE SYSTEM

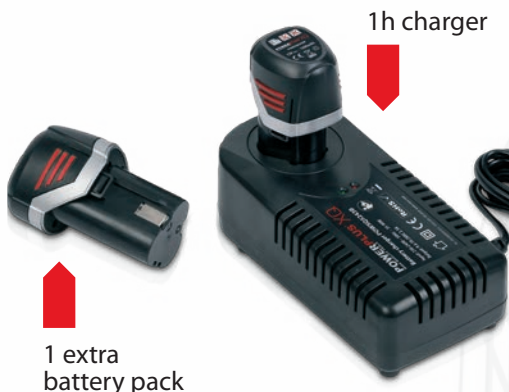

1 extra battery pack



■ **XQ5243B**  
Spare battery 12V  
Li-Ion 1300mAh





# CORDLESS DRILL LI-ION 18V

**POWXQ5250**



5 400338 052002 >



**5 YEAR WARRANTY**

RATED VOLTAGE	<b>18V</b>
2x BATTERY	<b>Li-Ion 2600mAh</b>
2 SPEED	<b>0-470/0-1700min<sup>-1</sup></b>
KEYLESS JACOBS CHUCK	<b>max. Ø13mm</b>
CHARGING TIME	<b>1h</b>
MAX. TORQUE	<b>45Nm</b>
TORQUE SETTINGS	<b>25+2</b>

## FEATURES

- 2 LI-ION BATTERIES
- IMPACT FUNCTION
- LED LIGHT
- BUCKLE
- MAGNETIC PLATE
- BUILT-IN BIT HOLDER
- KEYLESS CHUCK WITH QUICK SDS-TYPE SYSTEM
- AUXILIARY HANDLE



Including BMC



1h charger



■ **XQ5250B**  
Spare battery 18V  
Li-Ion 2600mAh



5 400338 052613 >

# MULTI-USE TOOL LI-ION 12V

**POWXQ5271**



5 400338 051623 >



**5 YEAR WARRANTY**

<b>RATED VOLTAGE</b>	<b>12V</b>
<b>BATTERY</b>	<b>1300mAh</b>
<b>BATTERY TYPE</b>	<b>Li-Ion</b>
<b>ROTATION SPEED (6 POSITIONS)</b>	<b>10000- 20000min<sup>-1</sup></b>
<b>CHARGING TIME</b>	<b>1h</b>

## FEATURES

- LI-ION BATTERY 1300mAh
- ALU GEAR BOX
- SOFT PAINTING



# INTERCHANGEABLE LI-ION BATTERIES

PURCHASE BOTH POWER TOOLS SO THE INTERCHANGEABLE  
BATTERIES ALLOW FOR CONTINUOUS USE WITH NO  
DOWN TIME

## LI-ION

- + **no** self discharge + **no** memory effect
- + **more** energy and **better** performance
- + **environmentally friendly**



### CORDLESS DRILL **LI-ION 12V**

CHARGING TIME 1 HOUR



### MULTI-USE TOOL **LI-ION 12V**

CHARGING TIME 1 HOUR

# IMPACT DRILL 850W

**POWXQ5203**



5 400338 042201 >



**5 YEAR  
WARRANTY**



VOLTAGE - FREQUENCY	230-240V~ 50Hz
RATED POWER	850W
ROTATION SPEED	0-2800min <sup>-1</sup>
KEYLESS PEACOCK CHUCK (METAL / PP)	max. 13mm
IMPACTS PER MINUTE	0-44800
RUBBER CABLE	4m

## FEATURES

- MAGNESIUM DIE-CAST
- IMPACT FUNCTION
- SWIVEL BALL CABLE RESTRAINT
- AUXILIARY HANDLE



# IMPACT DRILL 1200W

**POWXQ5205**



5 400338 042218 >

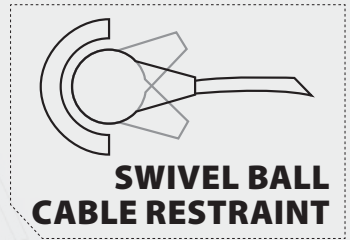

**5 YEAR  
WARRANTY**



VOLTAGE - FREQUENCY	230-240V~ 50Hz
RATED POWER	1200W
ROTATION SPEED	0-1000/0-2800min <sup>-1</sup>
KEYLESS PEACOCK CHUCK (METAL)	max. 13mm
IMPACTS PER MINUTE	0-19000/ 0-53200
RUBBER CABLE	4m

## FEATURES

- MAGNESIUM DIE-CAST
- IMPACT FUNCTION
- SWIVEL BALL CABLE RESTRAINT
- AUXILIARY HANDLE

# HAMMER DRILL 520W

**POWXQ5220**



5 400338 051470 >

**5 YEAR WARRANTY**



Steel depth stop

SDS-plus type chuck

Including BMC



2 pcs SDS-plus type chisel flat 14 x 250mm & pointed 250mm

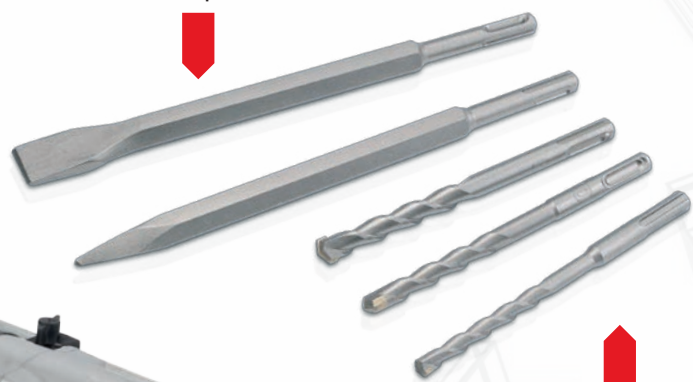

3 pcs SDS-plus type drill 8/10/12mm x 150mm



Soft grip

VOLTAGE - FREQUENCY	230-240V~ 50Hz
RATED POWER	520W
ROTATION SPEED	820min <sup>-1</sup>
IMPACTS PER MINUTE	3000
RUBBER CABLE	4m
WEIGHT	± 3.5kg

## FEATURES

- MAGNESIUM DIE-CAST
- 3 FUNCTIONS: HAMMERING, DRILLING & CHISELING
- AUXILIARY HANDLE

# HAMMER DRILL 1500W

**POWXQ5223**



5 400338 043000 >

Antivibration system

Steel depth stop

SDS-plus type chuck

Including BMC



13mm key chuck



2 pcs SDS-plus type chisel flat 22 x 250mm & pointed 250mm



3 pcs SDS-plus type drill 8/10/12mm x 150mm

VOLTAGE - FREQUENCY	230-240V~ 50Hz
RATED POWER	1500W
ROTATION SPEED	800min <sup>-1</sup>
IMPACTS PER MINUTE	3900
RUBBER CABLE	4m
WEIGHT	± 5.7kg

## FEATURES

- MAGNESIUM DIE-CAST
- 3 FUNCTIONS: HAMMERING, DRILLING & CHISELING
- SWIVEL BALL CABLE RESTRAINT
- VIBRATION REDUCTION (AVS)
- AUXILIARY HANDLE

Soft grip

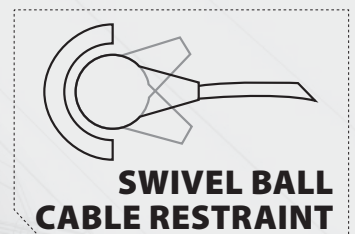

**5 YEAR WARRANTY**

# HAMMER DRILL 1250W

**POWXQ5226**



5 400338 051487 >

**5 YEAR WARRANTY**

SDS-max type chuck

Double antivibration system

Soft grip

Including BMC



Double antivibration system

VOLTAGE - FREQUENCY	230-240V~ 50Hz
RATED POWER	1250W
ROTATION SPEED	450min <sup>-1</sup>
IMPACTS PER MINUTE	2800
RUBBER CABLE	4m
WEIGHT	± 6.8kg



2 pcs SDS-max type chisel flat 25 x 350mm & pointed 350mm

3 pcs SDS-max type drill 6/18/22mm x 320mm

## FEATURES

- MAGNESIUM DIE-CAST
- 2 FUNCTIONS: HAMMERING & CHISELING
- SDS-MAX TYPE CHUCK
- DOUBLE VIBRATION REDUCTION (AVS)
- AUXILIARY HANDLE



Steel depth stop



# FINISHING SANDER 250W

**POWXQ5401**



5 400338 042126 >

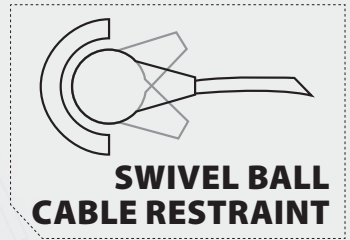

Soft grip

Magnesium die-cast

**5 YEAR  
WARRANTY**

Dust bag included

2 paper clamps

VOLTAGE - FREQUENCY	230-240V~ 50Hz
RATED POWER	250W
OSCILLATION SPEED	22000min <sup>-1</sup>
SANDING SURFACE	90x184mm
RUBBER CABLE	4m

## FEATURES

- MAGNESIUM DIE-CAST
- HOOK & LOOP SYSTEM
- 2 PAPER CLAMPS
- SWIVEL BALL CABLE RESTRAINT



Hook & loop system

Lock-on button

# BELT SANDER 1200W

**POWXQ5406**



5 400338 042133 >



← Dust bag included

**5 YEAR  
WARRANTY**



Lock-on button

← Soft grip

↑ Belt centering knob

↑ Magnesium die-cast

<b>VOLTAGE - FREQUENCY</b>	<b>230V~ 50Hz</b>
<b>RATED POWER</b>	<b>1200W</b>
<b>BELT SPEED</b>	<b>500m/min</b>
<b>SANDING SURFACE</b>	<b>100x210mm</b>
<b>BELT SIZE</b>	<b>610x100mm</b>
<b>RUBBER CABLE</b>	<b>4m</b>

↓ Sanding belt G120 included



## FEATURES

- MAGNESIUM DIE-CAST
- EXTERNAL BRUSH CAPS
- SWIVEL BALL CABLE RESTRAINT

# ELECTRIC PLANER 800W

**POWXQ5502**



5 400338 042157 >



**SWIVEL BALL  
CABLE RESTRAINT**



Dust bag included

Lock-on button

Soft grip

**5 YEAR  
WARRANTY**

Ratcheting depth knob

Magnesium die-cast

Side guide

VOLTAGE - FREQUENCY	230V~ 50Hz
RATED POWER	800W
ROTATION SPEED	15000min <sup>-1</sup>
CUTTING WIDTH	82mm
MAX. CUTTING DEPTH	2mm
RUBBER CABLE	4m

## FEATURES

- MAGNESIUM DIE-CAST
- DUST BAG
- SWIVEL BALL CABLE RESTRAINT



Fence guide

# ANGLE GRINDER 950W 115mm

**POWXQ5102**



5 400338 042171 >



**5 YEAR  
WARRANTY**



Spindle lock button

VOLTAGE - FREQUENCY	230-240V~ 50Hz
RATED POWER	950W
ROTATION SPEED	10500min <sup>-1</sup>
DISC SIZE	Ø115mm
RUBBER CABLE	4m



Soft grip

Magnesium die-cast

Auxiliary handle for 3 positions

Safety guard with quick clamp system

## FEATURES

- MAGNESIUM DIE-CAST
- QUICK CLAMP SYSTEM
- SWIVEL BALL CABLE RESTRAINT

(DISC NOT INCLUDED)

# ANGLE GRINDER 1300W 125mm

**POWXQ5104**



5 400338 042188 >



VOLTAGE - FREQUENCY	230-240V~ 50Hz
RATED POWER	1300W
ROTATION SPEED	9000min <sup>-1</sup>
DISC SIZE	Ø125mm
RUBBER CABLE	4m



**5 YEAR  
WARRANTY**

## FEATURES

- MAGNESIUM DIE-CAST
- QUICK CLAMP SYSTEM
- SWIVEL BALL CABLE RESTRAINT

(DISC NOT INCLUDED)

# ANGLE GRINDER 2450W 230mm

**POWXQ5107**



5 400338 042195 >



**5 YEAR  
WARRANTY**



Spindle lock button

VOLTAGE - FREQUENCY	230-240V~ 50Hz
RATED POWER	2450W
ROTATION SPEED	6000min <sup>-1</sup>
DISC SIZE	Ø230mm
RUBBER CABLE	4m

Soft grip

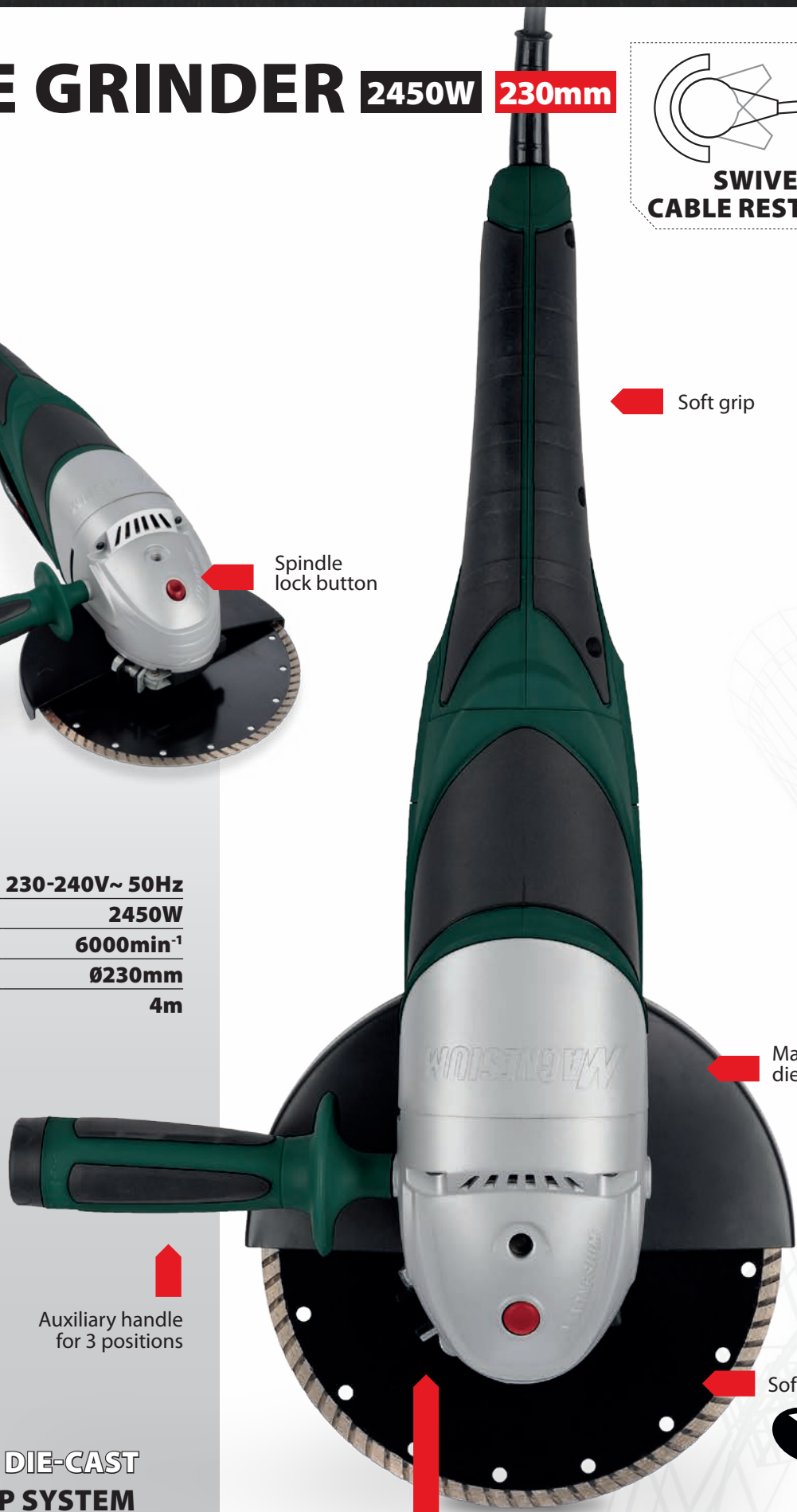

Magnesium die-cast

Auxiliary handle for 3 positions

Soft start

Safety guard with quick clamp system

(DISC NOT INCLUDED)

## FEATURES

- MAGNESIUM DIE-CAST
- QUICK CLAMP SYSTEM
- SOFT START
- SWIVEL BALL CABLE RESTRAINT

# JIGSAW 900W

**POWXQ5302**



5 400338 042119 >



**5 YEAR  
WARRANTY**



VOLTAGE - FREQUENCY	230-240V~ 50Hz
RATED POWER	900W
ROTATION SPEED	500-3000min <sup>-1</sup>
PENDULAR POSITIONS	0/1/2/3
RUBBER CABLE	4m

## FEATURES

- MAGNESIUM DIE-CAST
- LASER
- FITS ALL TYPES OF BLADES
- SWIVEL BALL CABLE RESTRAINT



# CIRCULAR SAW 1350W

**POWXQ5313**



5 400338 042140 >



**5 YEAR  
WARRANTY**



VOLTAGE - FREQUENCY	230-240V~ 50Hz
RATED POWER	1350W
ROTATION SPEED	5000min <sup>-1</sup>
BLADE SIZE	Ø185x20x2.4mm-24T
RUBBER CABLE	4m
MAX. CUTTING CAPACITY	90°: 62mm 45°: 41mm

## FEATURES

- MAGNESIUM DIE-CAST
- LASER
- SWIVEL BALL CABLE RESTRAINT





# CIRCULAR SAW 1800W

**POWXQ5315**



5 400338 042164 >

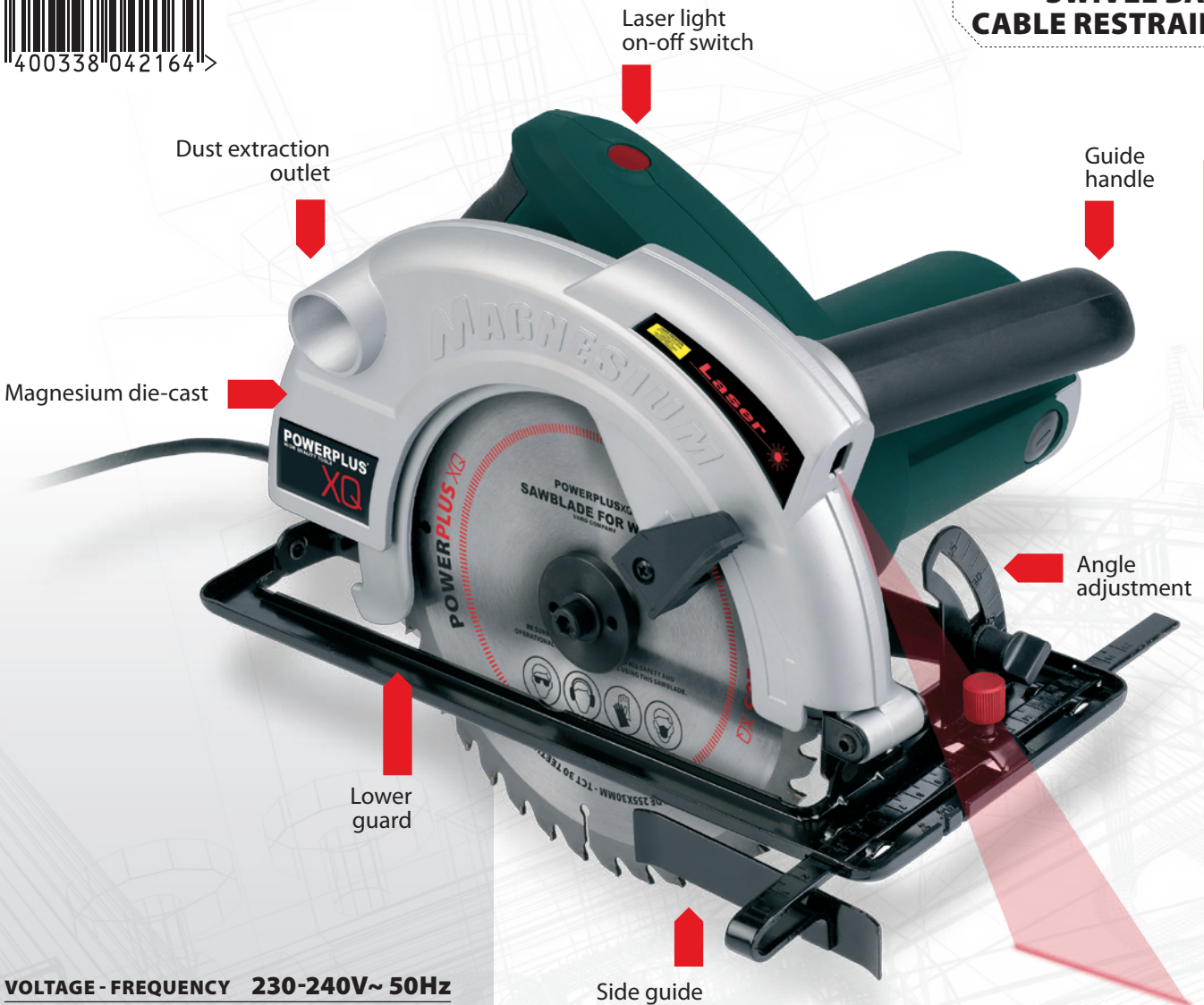

**5 YEAR  
WARRANTY**

VOLTAGE - FREQUENCY	230-240V~ 50Hz
RATED POWER	1800W
ROTATION SPEED	5000min <sup>-1</sup>
BLADE SIZE	Ø210x30x2.4mm-24T
RUBBER CABLE	4m
MAX. CUTTING CAPACITY	90°: 74mm 45°: 55mm

## FEATURES

- MAGNESIUM DIE-CAST
- LASER
- SWIVEL BALL CABLE RESTRAINT



(BLADE INCLUDED)

# MITRE SAW 1500W 254mm

**POWXQ5330**



5 400338 042225 >

**5 YEAR WARRANTY**

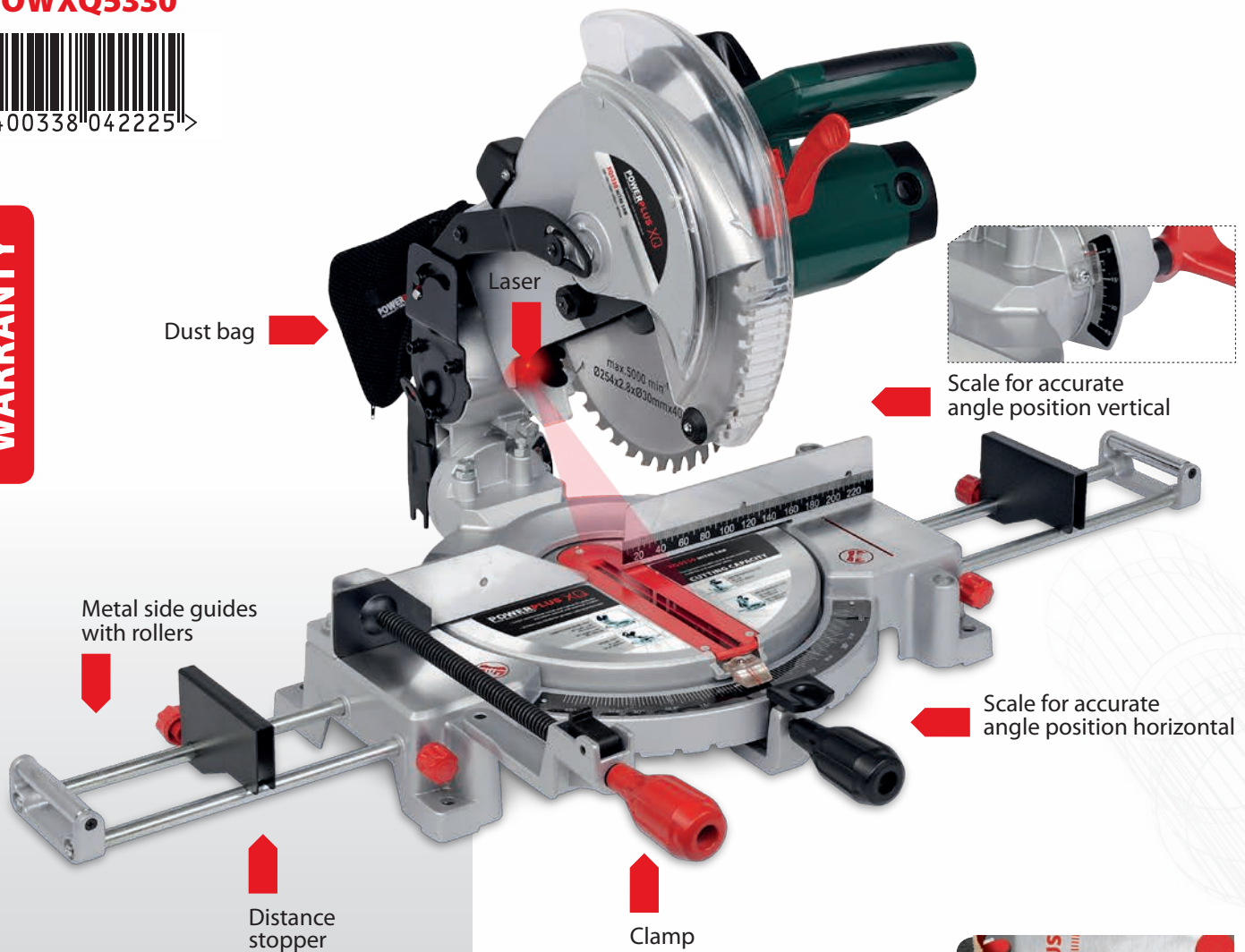

<b>VOLTAGE - FREQUENCY</b>	<b>230V~ 50Hz</b>
<b>RATED POWER</b>	<b>1500W</b>
<b>ROTATION SPEED</b>	<b>4500min<sup>-1</sup></b>
<b>BLADE SIZE</b>	<b>Ø254x30x2.8mm-40T</b>
<b>MAX. CUTTING CAPACITY (HxL)</b>	

90° x 90°:	75x130mm
45° left x 90°:	75x90mm
45° right x 90°:	75x90mm
90° x 45°:	50x130mm
45° left x 45°:	50x90mm
45° right x 45°:	50x90mm

## FEATURES

- **LASER**
- **2 METAL SIDE GUIDES + ROLLERS**
- **VERY ACCURATE ANGLE POSITIONING**
- **ADJUSTABLE CLAMP**



Also available in our assortment: suitable support stand  
**POWXQ53300T**  
p. 37



5 400338 042881 >

# TELESCOPIC MITRE SAW 1800W 254mm

**POWXQ5335**



5 400338 042232 >

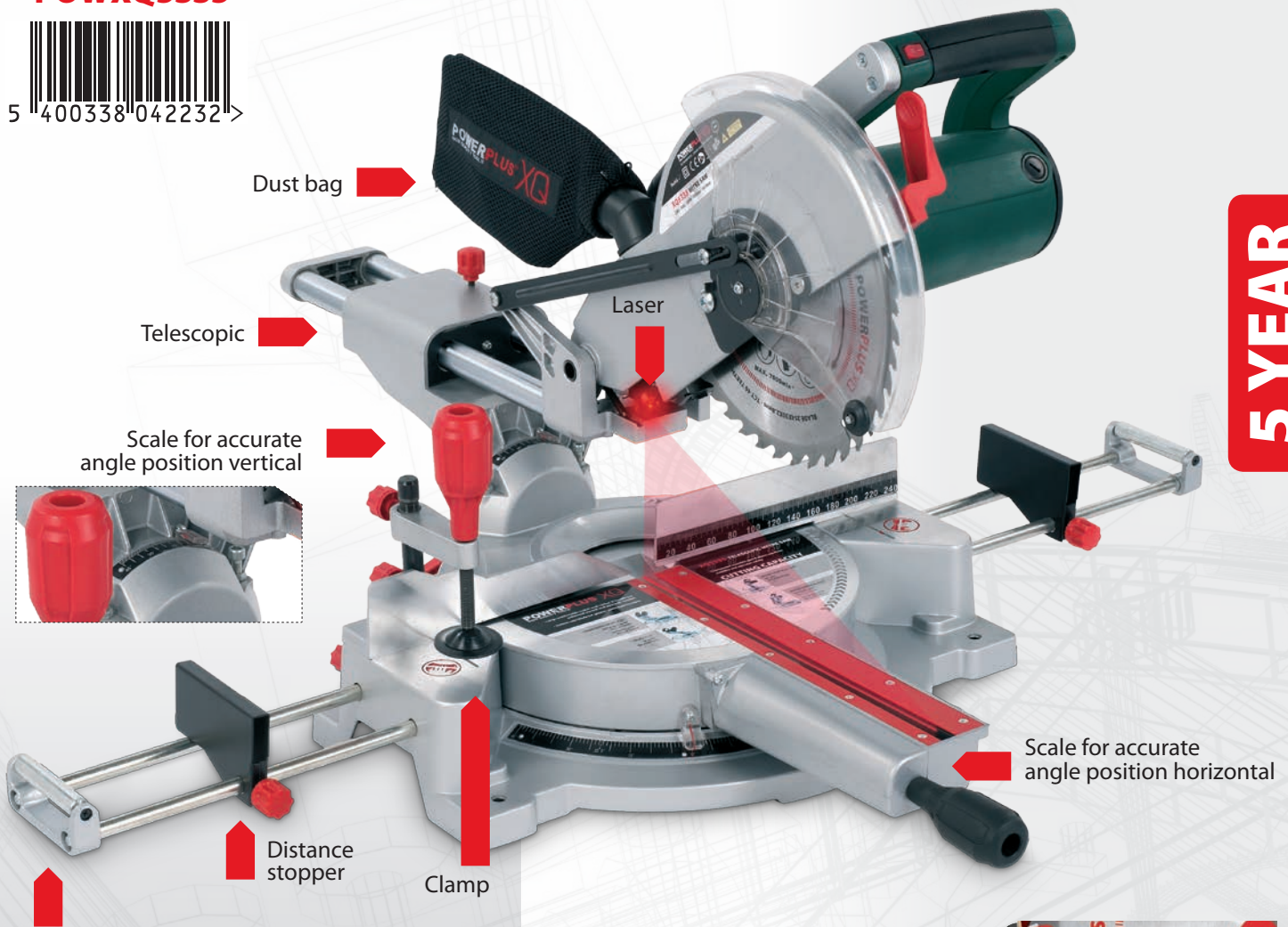

**5 YEAR WARRANTY**



Metal side guides with rollers

<b>VOLTAGE - FREQUENCY</b>	<b>230V~ 50Hz</b>
<b>RATED POWER</b>	<b>1800W</b>
<b>ROTATION SPEED</b>	<b>4500min<sup>-1</sup></b>
<b>BLADE SIZE</b>	<b>Ø254x30x2.8mm-40T</b>
<b>MAX. CUTTING CAPACITY (HxL)</b>	

90° x 90°:	90x305mm
45° left x 90°:	90x215mm
45° right x 90°:	90x215mm
90° x 45°:	42x305mm
45° left x 45°:	42x215mm
45° right x 45°:	42x215mm

## FEATURES

- TELESCOPIC
- LASER
- 2 METAL SIDE GUIDES + ROLLERS
- VERY ACCURATE ANGLE POSITIONING
- ADJUSTABLE CLAMP



Also available in our assortment: suitable support stand  
**POWXQ53300T**  
p. 37



5 400338 042881 >

# MITRE & TABLE SAW 2-IN-1 1800W 305mm

**POWXQ5350**



5 400338 042058 >

**5 YEAR WARRANTY**

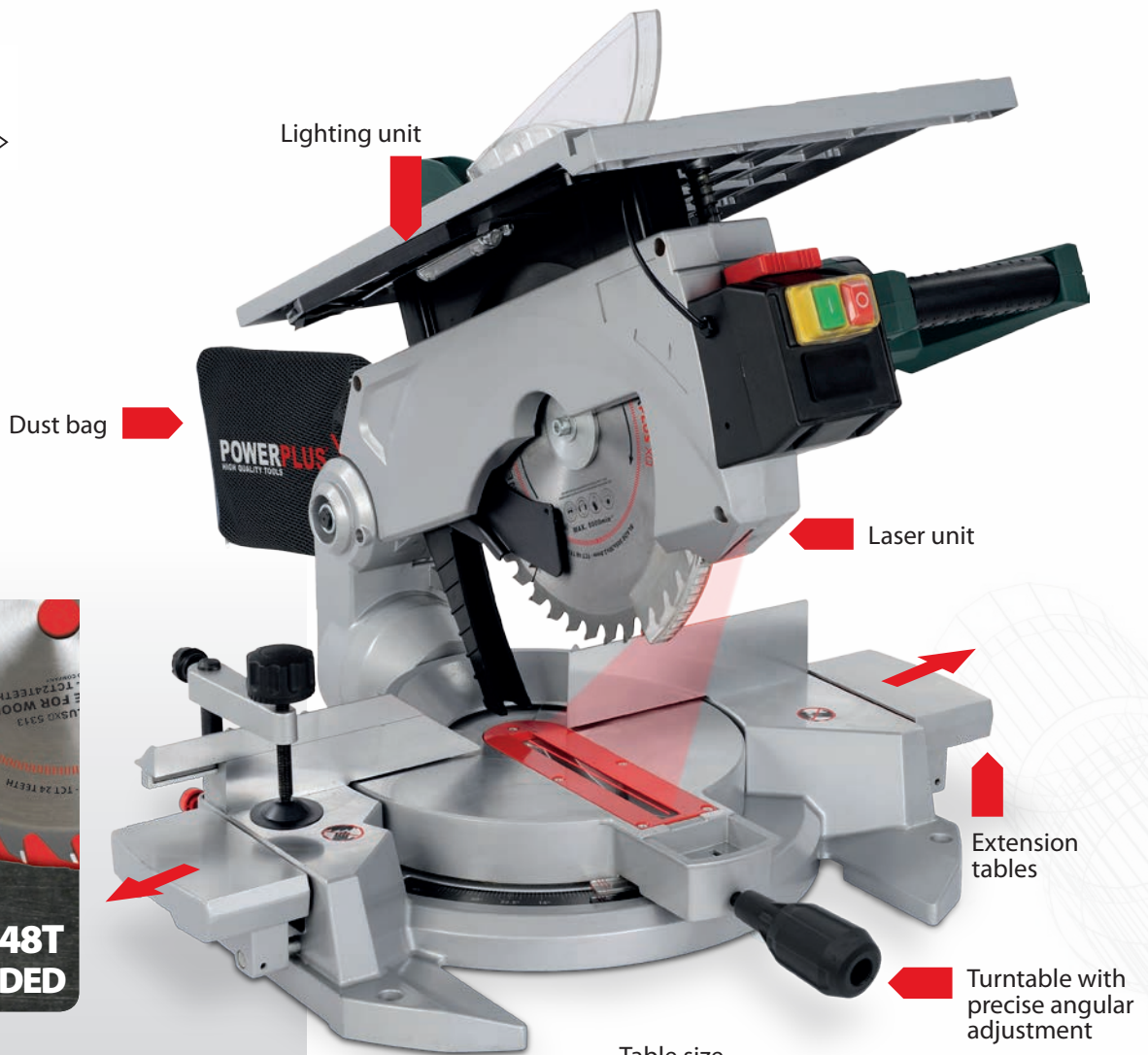

**VOLTAGE - FREQUENCY** 230V~ 50Hz

**RATED POWER** 1800W

**ROTATION SPEED** 3800min<sup>-1</sup>

**BLADE SIZE** Ø305x30x2.8mm-48T

**CUTTING CAPACITY TABLE SAW** 50mm

**MAX. CUTTING CAPACITY MITRE SAW (HxL)**

90° x 90°: 95x150mm

45° left x 90°: 70x100mm

45° right x 90°: 95x100mm

90° x 45°: 60x150mm

45° left x 45°: 45x70mm

45° right x 45°: 45x100mm

## FEATURES

- LASER & LIGHTING UNIT
- EXTENSION TABLES
- STURDY AND PRECISE ALU CAST CONSTRUCTION
- MAGNETIC ON/OFF SWITCH
- CIRCUIT BREAKER

Table size  
470 x 335mm



Extension tables

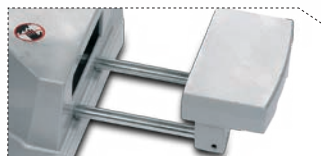

Also available in our assortment: suitable support stand

**POWXQ53300T**

p. 37



5 400338 042881 >

# TABLE SAW 1800W 254mm

**POWXQ5360**



Sliding mitre table

Table size: 645x530mm with extensions: 850x860mm

Mitre gauge

90°-45°

Rip fence with magnifying lens

Blade raising & tilting control handle

Side table & rear table extension

Storage compartments

VOLTAGE - FREQUENCY	230-240V~ 50Hz
RATED POWER	1800W
ROTATION SPEED	4500min <sup>-1</sup>
BLADE SIZE	Ø254x30x2.8mm-40T
MAX. CUTTING CAPACITY	90°: 80mm 45°: 55mm

## FEATURES

- SLIDING MITRE TABLE
- TABLE WITH EXTENSIONS mm & cm INDICATION
- STORAGE SPACE FOR ALL ACCESSORIES
- MAGNETIC ON/OFF SWITCH

**5 YEAR WARRANTY**



**Ø254x  
30x2.8mm - 40T  
BLADE INCLUDED**

Also available in our assortment: suitable support stand

**POWXQ53600T**  
p. 37



# TILE CUTTER 750W 180mm

**POWXQ5320**



5 400338 051180 >

**5 YEAR WARRANTY**



Water reservoir  
3.3 l

Bevel table  
3 positions:  
0° / 22.5° / 45°

**INCLUDED:**  
Folding stand

Table size  
500x380mm

Cord retainer



PRCD (portable residual current device)

Comfortable working height 855mm

VOLTAGE - FREQUENCY	230V~ 50Hz
RATED POWER	750W
ROTATION SPEED	2950min <sup>-1</sup>
BLADE SIZE	Ø180x22.2x2.2mm
MAX. CUTTING CAPACITY	90°: 30mm 45°: 14mm

Chrome plated table top



Rip guide scale (mm)

Rip & mitre guide

## FEATURES

- CHROME PLATED TABLE TOP
- CABLE STORAGE
- PRCD
- COMFORTABLE WORKING HEIGHT (STAND INCLUDED)

# CUT-OFF SAW 2000W 355mm

**POWXQ5390**



5 400338 051241 >



D-shaped handle



Sturdy metal base plate

**5 YEAR WARRANTY**

**VOLTAGE - FREQUENCY** 230-240V~ 50Hz  
**RATED POWER** 2000W  
**ROTATION SPEED** 3500min<sup>-1</sup>  
**BLADE SIZE** Ø355x25.4x3mm  
**MITRE ANGLE** 30°/45°  
**MAX. CUTTING CAPACITY**

	90°	45°
○	Ø100mm	Ø80mm
□	100x100mm	60x60mm
▭	120x95mm	85x60mm
L	100x100mm	60x60mm

## FEATURES

- HIGH QUALITY CUTTING BLADE INCLUDED
- D-SHAPED HANDLE
- EASY CLAMPING SYSTEM
- STURDY BASE PLATE



Spindle lock

Wheel guard

High quality cutting blade included

Adjustable depth stop

Angle plate

# HEAT GUN 2000W

**POWXQ6104**



5 400338 051500 >

**5 YEAR WARRANTY**



Air vents

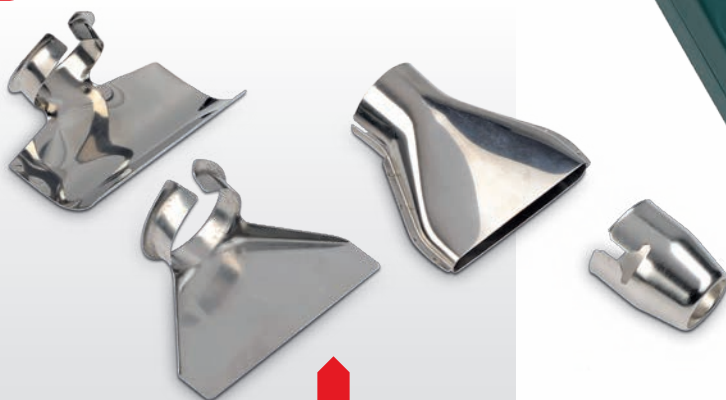

4 nozzles

**VOLTAGE - FREQUENCY 220-240V~ 50Hz**

**RATED POWER 2000W**

**CABLE LENGTH 4m**

**TEMPERATURE & AIR FLOW**

I: 50°C • 300 l/min

II: 400°C • 300 l/min

III: 600°C • 500 l/min



On/off switch

## FEATURES

- CONSTANT HEAT CONTROL
- MIN. LIFETIME 400h
- WITH THERMO PROTECTOR CUT-OUT
- COOL ZONE



# HEAT GUN 2000W

**POWXQ6110**



5 400338 051517 >



Air vents

**5 YEAR WARRANTY**

4 nozzles & stainless steel scraper

VOLTAGE - FREQUENCY	220-240V~ 50Hz
RATED POWER	2000W
CABLE LENGTH	4m
TEMPERATURE & AIR FLOW	
I: 50°C • 250-500 l/min	
II: 50-650°C • 250-500 l/min	

## FEATURES

- CONSTANT HEAT CONTROL
- ELECTRONIC VARIABLE TEMPERATURE & AIR FLOW
- LCD DISPLAY WITH TEMPERATURE & AIR FLOW INDICATOR
- MIN. LIFETIME 450h
- WITH THERMO PROTECTOR CUT-OUT
- COOL ZONE



LCD display

Temperature & air flow adjusting buttons

On/off switch

Including BMC



# COMPRESSOR 1600W 2.5HP 10 bar 24L

**POWXQ8105**



5 400338 047237 >

**5 YEAR WARRANTY**



VOLTAGE - FREQUENCY	220-240V~ 50Hz
RATED POWER	2.5HP / 1600W
AIR FLOW	250 l/m
RATED PRESSURE	10 bar
TANK	24 l
UNIVERSAL COUPLERS	2x

## FEATURES

- 5m RUBBER HOSE
- LUBRICATED PUMP
- UNIVERSAL COUPLERS
- RUBBER WHEELS

**OIL NOT INCLUDED**



5m rubber hose on hose reel



**POWOIL012**

■ **POWOIL012**  
Compressor oil  
1 l



5 400338 041785 >

# COMPRESSOR 2200W 3HP 10 bar 50L

**POWXQ8125**



5 400338 047220



**5 YEAR WARRANTY**

VOLTAGE - FREQUENCY	220-240V~ 50Hz
RATED POWER	3HP / 2000W
AIR FLOW	270 l/m
RATED PRESSURE	10 bar
TANK	50 l
DIRECT COUPLER	1x
UNIVERSAL COUPLER	1x

## FEATURES

- BELT DRIVEN PUMP
- DIRECT COUPLER
- UNIVERSAL COUPLER
- RUBBER WHEELS

**OIL NOT INCLUDED**



■ **POWOIL012**  
Compressor oil  
1 l



5 400338 041785

# CLAMPING STAND

**POWXQ9100**



5 400338 052514 >



**5 YEAR WARRANTY**



**INSTRUCTION MOVIE ON WEBSITE**  
[WWW.POWERPLUSXQ.COM](http://WWW.POWERPLUSXQ.COM)

<b>CLAMPING RANGE</b>	<b>0-450/0-950mm</b>
<b>CLAMPING FORCE</b>	<b>max. 10000N</b>
<b>LOAD</b>	<b>max. 150kg</b>
<b>CLAMPING METHOD</b>	<b>foot pedal</b>
<b>CLAMP TRAVEL (PER STROKE)</b>	<b>24mm/step</b>

## FEATURES

- STABLE TRIPOD BASE
- EASY CLAMP SYSTEM
- REVERSIBLE BACK CLAMP
- FOLDABLE & COMPACT STORAGE



# SUPPORT STAND

**POWXQ53300T**



5 400338 042881 >

## FEATURES

- STEEL TABLE
- STEEL STAND
- ADJUSTABLE LEG TO STABILISE THE TABLE

Table size 580x520mm



Table height 840mm



Adjustable leg



**SUITABLE FOR  
MITRE AND  
TABLE SAWS**



**POWXQ5330**

&



**POWXQ5335**

&



**POWXQ5350**

# SUPPORT STAND

**FOR TABLE SAW POWXQ5360**

**POWXQ53600T**



5 400338 051531 >

## FEATURES

- FOLDABLE
- VERY SOLID
- EASY LIFTING WITH TURNING WHEEL

Extendable handle



570mm

890mm

Table size 710x540mm



330mm

Big solid wheels  
Ø200mm with brakes



# MULTITOOL 15-IN-1

**POWXQ9756**



Scissors  
Saw blade  
Can opener  
Bottle opener

Screwdrivers  
Knives  
File  
Fish hook remover

Pliers  
Wire cutter



## FEATURES

- 15-IN-1 FUNCTIONS
- STAINLESS STEEL CONSTRUCTION
- FOLDS CLOSE TO 100mm
- NYLON BELT POUCH

# RETRACTABLE UTILITY KNIFE

**POWXQ9753**

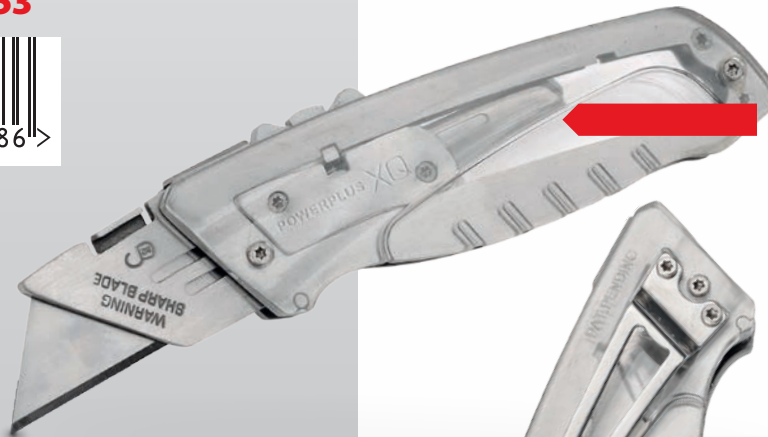

Slide back for safe storage & blade protection



Sure-grip aluminium handle with belt clip



5 replacement blades included

## FEATURES

- ONE HANDED ACTION & SAFETY MECHANISM
- SAFE STORAGE & BLADE PROTECTION
- QUICK BLADE RELEASE FOR EASY CHANGING

# METAL BOX 120L

**POWXQ9255**



5 400338 043260 >

800x450x335mm



120 l



Content not included

## FEATURES

- THICKNESS: 0.5mm
- NET WEIGHT: 8.5kg
- CUBAGE: 120 l

FOR MORE ACCESSORIES

# CHECK OUT OUR KREATOR RANGE

[www.kreator.be](http://www.kreator.be)



# KREATOR

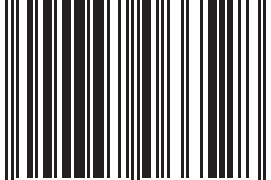

5 400338 066528 >

**varo**

**VIC. VAN ROMPUY nv**

JOSEPH VAN INSTRAAAT 9  
2500 LIER - BELGIUM  
TEL +32 (0)3 292.92.92  
FAX +32 (0)3 292.92.72  
E-MAIL: [INFO@VARO.COM](mailto:INFO@VARO.COM)  
[WWW.VARO.COM](http://WWW.VARO.COM)

**OFFICES:**

IBERICA BRICOLAGE S.L. - ESPAÑA  
ASIA PACIFIC HONG KONG Ltd / SHANGHAI PRC  
AUSTRALIA Pty Ltd / GERMANY GmbH

XQ

**POWERPLUS**<sup>®</sup> XQ  
HIGH QUALITY TOOLS

**5 YEAR  
WARRANTY**

© Copyright VARO - Vic. Van Rompuy nv 2014 / Product specifications are subject to change without notice. VARO is not responsible for typographical or photographic errors that may appear in this catalogue. Pictures may vary from the actual products. We reserve the right to make adjustments or corrections due to errors, changing market conditions, product discontinuations, or typographic or photographic errors in advertisements or product descriptions. Item availability and prices are subject to change without notice.

SDS<sup>®</sup> is a registered trademark of Robert Bosch GmbH. / Torx<sup>®</sup> is a registered trademark of Acument Intellectual Properties, LLC.